



Our Range of Best Selling Instruments

**SURGICAL  
INSTRUMENTS  
CATALOGUE**



[www.andimaxsurgical.com](http://www.andimaxsurgical.com)

# Content



S.No	Descriptions of Items	
01	Skalpellsklingen, Skalpellsgriffe, Messer Scalpel Blades, Scalpel Handles, Knives Hojas de bisturíes, Mangos de bisturíes, Cuchillos Lame per bisturi, Manici per bisturi, Coltelli	<a href="#">Click Here</a>
02	Scheren , Scissors, Tijeras ,Forbici	<a href="#">Click Here</a>
03	Pinzetten, Forceps, Pinzas, Pinze	<a href="#">Click Here</a>
04	Tuch-, Schlauchklemmen, Tupferzangen Towel Clamps, Sponge and Dressing Forceps, Tubing Clamps Pinzas de campo, Pinzas para vendajes y torundas y para tubos Pinze per fissare le compresse, per medicatura e tamponi, e per tubi	<a href="#">Click Here</a>
05	Klemmen, Forceps, Pinas, Pinze	<a href="#">Click Here</a>
06	Nahtinstrumente, Suture Instruments, Instrumentos para sutura Strumenti per sutura	<a href="#">Click Here</a>
07	Wundhaken, Retractors, Separadores , Divaricatori	<a href="#">Click Here</a>
08	Wundspreizer, Self -Retaining Retractors, Separadores con retenida automática Divaricatori autostatici	<a href="#">Click Here</a>
09	Sonden, Trokare Probes, Trocars Sondas, Trócares Sonde, Trequarti	<a href="#">Click Here</a>
10	Magen, Darm, Mastdarm, Stomach, Intestines, Rectum Estómago, Intestino, Recto, Stomaco, Intestino, Retto	<a href="#">Click Here</a>
11	Galle, Leber, Niere, Blase, Urologie Gall, Liver, Kidney, Bladder, Urology Bilis, Hígado, Riñon, Vejiga, Urología Bile, Fegato, Rene, Vescica, Urologia	<a href="#">Click Here</a>
12	Gynäkologie, Geburtshilfe, Gynecology, Obstetrics, Ginecología, Obstetricia Ginecologia, Ostetricia	<a href="#">Click Here</a>
13	Vorbereitung, Dermatologie , Preparation, Dermatology Preparación, Dermatología Preparazione, Dermatalogia	<a href="#">Click Here</a>
14	Knochenchirurgie, Bone Surgery, Cirugía ósea, Chirurgia ossea	<a href="#">Click Here</a>
15	Sterilisation, Sterilization, Esterilización, Sterilizzazione	<a href="#">Click Here</a>



**Skalpellklingen, Skalpellgriffe, Messer  
Scalpel Blades, Scalpel Handles, Knives  
Hojas de bisturías, Mangos de bisturías, Cuchillos  
Lame per bisturi, Manici per bisturi, Coltelli**



Sterile Skalpellklingen, Skalpellgriffe  
Sterile Scalpel Blades, Scalpel Handles  
Hojas de bisturios estériles, Mangos de bisturios  
Lame per bisturi sterili, Manici per bisturi



No. 3  
13,0 cm, 5"  
AK-1003-03



No. 3  
13,0 cm, 5"  
AK-1003-04



No. 3L  
21,0 cm, 8¼"  
AK-1003-05



No. 7  
16,5 cm, 6½"  
AK-1007-06



No. 7K  
13,0 cm, 5"  
AK-1007-07

Sterile Skalpellklingen, Skalpellgriffe  
Sterile Scalpel Blades, Scalpel Handles  
Hojas de bisturíes estériles, Mangos de bisturíes  
Lame per bisturi sterili, Manici per bisturi



No. 4  
13,5 cm, 5 $\frac{3}{8}$ "  
AK-1004-04



No. 4L  
21,0 cm, 8 $\frac{3}{8}$ "  
AK-1004-04L



No. 8  
13,5 cm, 5 $\frac{3}{8}$ "  
AK-1004-08



No. 9  
14,5 cm, 5 $\frac{3}{4}$ "  
AK-1004-09

Einmal-Skalpelle, steril  
Disposable Scalpels, sterile  
Bisturios para uso único, estériles  
Bisturi monouso, sterili



Fig. 10  
AK-1005-10



Fig. 11  
AK-1005-11



Fig. 11s  
AK-1005-11S



Fig. 12  
AK-1005-12



Fig. 12d  
AK-1005-12D



Fig. 13  
AK-1005-13



Fig. 15  
AK-1005-15



Fig. 15c  
AK-1005-15C

Einmal-Skalpelle, steril  
 Disposable Scalpels, sterile  
 Bisturios para uso único, estériles  
 Bisturi monouso, sterili



Fig. 18  
AK-1005-18



Fig. 19  
AK-1005-19



Fig. 20  
AK-1005-20



Fig. 21  
AK-1005-21



Fig. 22  
AK-1005-22



Fig. 23  
AK-1005-23



Fig. 24  
AK-1005-24

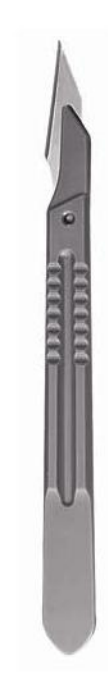

Fig. 25  
AK-1005-25

Skalpelle  
Knives  
Bisturies  
Bisturi



Fig. 1 **AK-1006-01**  
Fig. 2 **AK-1006-02**  
Fig. 3 **AK-1006-03**



**OPERATION**  
17,0 cm, 6<sup>3</sup>/<sub>4</sub>"

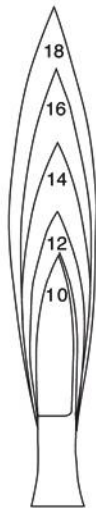

Fig. 10 **AK-1006-10**  
Fig. 12 **AK-1006-12**  
Fig. 14 **AK-1006-14**  
Fig. 16 **AK-1006-16**  
Fig. 18 **AK-1006-18**



**COLLIN**  
16,0 cm, 6<sup>1</sup>/<sub>4</sub>"



Fig. 4 **AK-1006-04**  
Fig. 5 **AK-1006-05**  
Fig. 6 **AK-1006-06**



Skalpelle  
Knives  
Bisturies  
Bisturi



Fig. 1 **AK-1007-01**  
Fig. 2 **AK-1007-02**  
Fig. 3 **AK-1007-03**  
Fig. 4 **AK-1007-04**  
Fig. 5 **AK-1007-05**



Fig. 1 **AK-1008-01**  
Fig. 2 **AK-1008-02**  
Fig. 3 **AK-1008-03**  
Fig. 4 **AK-1008-04**  
Fig. 5 **AK-1008-05**



Fig. 15 **AK-1008-15**



Fig. 6 **AK-1007-06**  
Fig. 7 **AK-1007-07**  
Fig. 8 **AK-1007-08**  
Fig. 9 **AK-1007-09**  
Fig. 10 **AK-1007-10**



Fig. 6 **AK-1008-06**  
Fig. 7 **AK-1008-07**  
Fig. 8 **AK-1008-08**  
Fig. 9 **AK-1008-09**

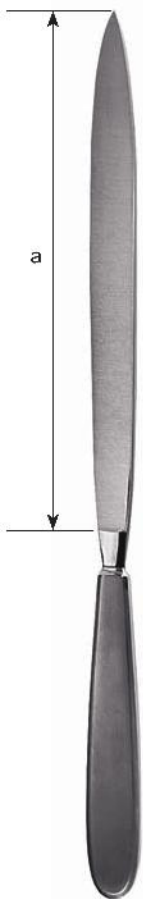

Fig. 16 **AK-1008-16**

**DISSECTING**  
17,0 cm, 6¾"

**DIEFENBACH**  
16,0 cm, 6¼"

Amputationsmesser  
Amputation Knives  
Cuchillos para amputación  
Coltelli per amputazione



**COLLIN**

a	
13,0 cm, 5"	<b>AK-1008-13</b>
16,0 cm, 6 <sup>1</sup> / <sub>4</sub> "	<b>AK-1008-16</b>
19,0 cm, 7 <sup>1</sup> / <sub>2</sub> "	<b>AK-1008-19</b>
22,0 cm, 8 <sup>5</sup> / <sub>8</sub> "	<b>AK-1008-22</b>
28,0 cm, 11"	<b>AK-1008-28</b>



**CATLIN**

A	
16,0 cm, 6 <sup>1</sup> / <sub>4</sub> "	<b>AK-1009-16</b>
19,0 cm, 7 <sup>1</sup> / <sub>2</sub> "	<b>AK-1009-19</b>
22,0 cm, 8 <sup>5</sup> / <sub>8</sub> "	<b>AK-1009-22</b>

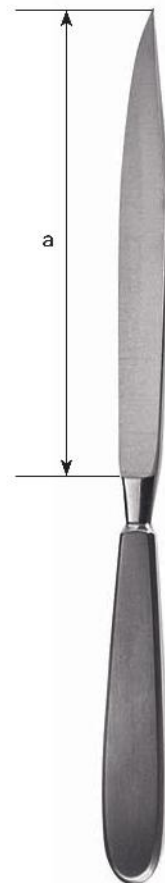

**LISTON**

A	
17,0 cm, 6 <sup>3</sup> / <sub>4</sub> "	<b>AK-1009-17</b>
20,0 cm, 8"	<b>AK-1009-20</b>
22,0 cm, 8 <sup>5</sup> / <sub>8</sub> "	<b>AK-1009-22</b>

Amputationsmesser, Messer für Autopsie  
Amputation Knives, Post Mortem Knives  
Cuchillos para amputación, Cuchillos para autopsia  
Coltelli per amputazione, Coltelli per autopsia

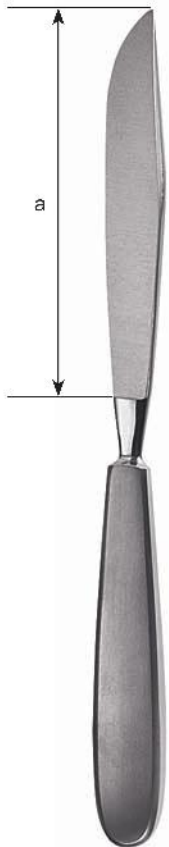

**LANGENBECK**  
AK-1010-16

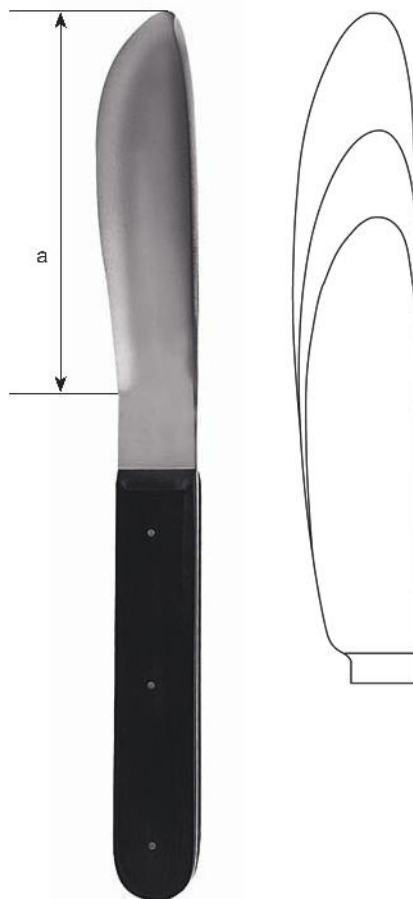

**WALB**

A	
11,0 cm, 4 1/2"	AK-1010-11
14,0 cm, 5 1/2"	AK-1010-14
17,0 cm, 6 3/4"	AK-1010-17

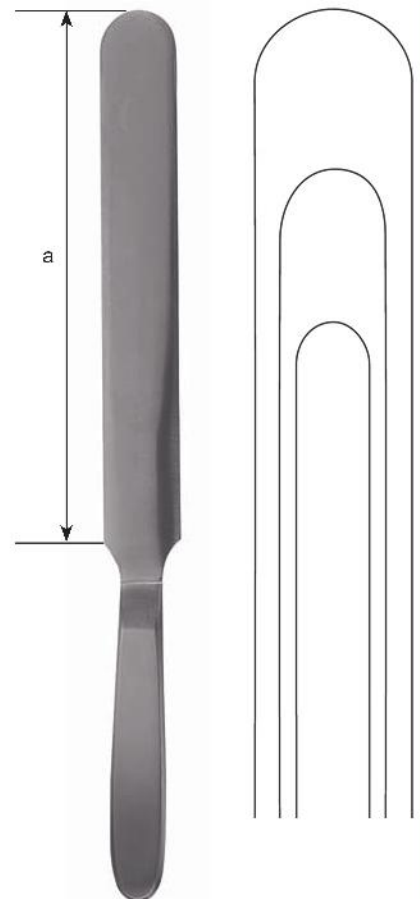

**VIRCHOW**

A	
16,0 cm, 6 1/4"	AK-1011-16
20,0 cm, 8"	AK-1011-20
24,0 cm, 9 1/2"	AK-1011-24

Amputationsmesser, Dermatome  
Amputation Knives, Dermatomes  
Cuchillos para amputación, Dermátomos  
Coltelli per amputazione, Dermatomi



**LANGENBECK**  
18,0 cm, 7"  
AK-1011-55



mit Schaber  
with raspatory  
con periostótomo  
con raschiatoio

**CARTILAGE**  
17,5 cm, 6<sup>5</sup>/<sub>8</sub>"  
AK-1011-65

Haut-Spannplatten  
Skin straightening plate  
Placa para extender la piel  
Placca per stendere la pelle



**AK-1011-30**

Resektionsmesser  
Resection Knives  
Cuchillos para resección  
Coltelli per resezione

**AK-1012-19**  
Ersatzklinge  
Spare blade  
Hoja de repuesto  
Lama di ricambio



**SILVER**  
19 cm, 7½"  
AK-1013-19

**AK-1012-30**  
Ersatzklinge  
Spare blade  
Hoja de repuesto  
Lama di ricambio



**BRAITHWAITE**  
30,0 cm, 12"  
AK-1013-30

**AK-1012-35**  
Ersatzklinge  
Spare blade  
Hoja de repuesto  
Lama di ricambio



**HUMBY**  
35,0 cm, 14"  
AK-1013-35

**AK-1012-30**  
Ersatzklinge  
Spare blade  
Hoja de repuesto  
Lama di ricambio



**SCHINK**  
30,0 cm, 12"  
AK-1013-30



**Scheren**  
**Scissors**  
**Tijeras**  
**Forbici**



Chirurgische Scheren  
Surgical Scissors  
Tijeras para cirugía  
Forbici per chirurgia



**STANDARD**

10,5 cm, 4 <sup>1</sup> / <sub>4</sub> "	<b>AK-1014-10</b>
11,5 cm, 4 <sup>1</sup> / <sub>2</sub> "	<b>AK-1014-11</b>
13,0 cm, 5"	<b>AK-1014-13</b>
14,5 cm, 5 <sup>3</sup> / <sub>4</sub> "	<b>AK-1014-14</b>
15,5 cm, 6"	<b>AK-1014-15</b>
16,5 cm, 6 <sup>1</sup> / <sub>2</sub> "	<b>AK-1014-16</b>
17,5 cm, 6 <sup>5</sup> / <sub>8</sub> "	<b>AK-1014-17</b>
18,5 cm, 7 <sup>1</sup> / <sub>4</sub> "	<b>AK-1014-18</b>
20,0 cm, 8"	<b>AK-1014-20</b>



**STANDARD**

10,5 cm, 4 <sup>1</sup> / <sub>4</sub> "	<b>AK-1015-10</b>
11,5 cm, 4 <sup>1</sup> / <sub>2</sub> "	<b>AK-1015-11</b>
13,0 cm, 5"	<b>AK-1015-13</b>
14,5 cm, 5 <sup>3</sup> / <sub>4</sub> "	<b>AK-1015-14</b>
15,5 cm, 6"	<b>AK-1015-15</b>
16,5 cm, 6 <sup>1</sup> / <sub>2</sub> "	<b>AK-1015-16</b>
17,5 cm, 6 <sup>5</sup> / <sub>8</sub> "	<b>AK-1015-17</b>
18,5 cm, 7 <sup>1</sup> / <sub>4</sub> "	<b>AK-1015-18</b>
20,0 cm, 8"	<b>AK-1015-20</b>



**STANDARD**

10,5 cm, 4 <sup>1</sup> / <sub>4</sub> "	<b>AK-1016-10</b>
11,5 cm, 4 <sup>1</sup> / <sub>2</sub> "	<b>AK-1016-11</b>
13,0 cm, 5"	<b>AK-1016-13</b>
14,5 cm, 5 <sup>3</sup> / <sub>4</sub> "	<b>AK-1016-14</b>
15,5 cm, 6"	<b>AK-1016-15</b>
16,5 cm, 6 <sup>1</sup> / <sub>2</sub> "	<b>AK-1016-16</b>
17,5 cm, 6 <sup>5</sup> / <sub>8</sub> "	<b>AK-1016-17</b>
18,5 cm, 7 <sup>1</sup> / <sub>4</sub> "	<b>AK-1016-18</b>
20,0 cm, 8"	<b>AK-1016-20</b>



**STANDARD**

10,5 cm, 4 <sup>1</sup> / <sub>4</sub> "	<b>AK-1017-10</b>
11,5 cm, 4 <sup>1</sup> / <sub>2</sub> "	<b>AK-1017-11</b>
13,0 cm, 5"	<b>AK-1017-13</b>
14,5 cm, 5 <sup>3</sup> / <sub>4</sub> "	<b>AK-1017-14</b>
15,5 cm, 6"	<b>AK-1017-15</b>
16,5 cm, 6 <sup>1</sup> / <sub>2</sub> "	<b>AK-1017-16</b>
17,5 cm, 6 <sup>5</sup> / <sub>8</sub> "	<b>AK-1017-17</b>
18,5 cm, 7 <sup>1</sup> / <sub>4</sub> "	<b>AK-1017-18</b>
20,0 cm, 8"	<b>AK-1017-20</b>

Chirurgische Scheren, Präparierscheren  
Surgical Scissors, Dissecting Scissors  
Tijeras para cirugía, Tijeras de disección  
Forbici per chirurgia, Forbici per dissezione

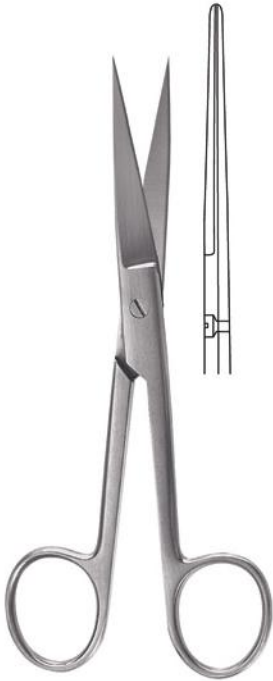

**STANDARD**

10,5 cm, 4 <sup>1</sup> / <sub>4</sub> "	<b>AK-1018-10</b>
11,5 cm, 4 <sup>1</sup> / <sub>2</sub> "	<b>AK-1018-11</b>
13,0 cm, 5"	<b>AK-1018-13</b>
14,5 cm, 5 <sup>3</sup> / <sub>4</sub> "	<b>AK-1018-14</b>
15,5 cm, 6"	<b>AK-1018-15</b>
16,5 cm, 6 <sup>1</sup> / <sub>2</sub> "	<b>AK-1018-16</b>
17,5 cm, 6 <sup>5</sup> / <sub>8</sub> "	<b>AK-1018-17</b>
18,5 cm, 7 <sup>1</sup> / <sub>4</sub> "	<b>AK-1018-18</b>
20,0 cm, 8"	<b>AK-1018-20</b>

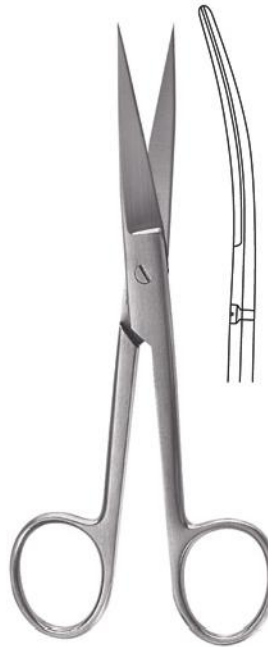

**STANDARD**

10,5 cm, 4 <sup>1</sup> / <sub>4</sub> "	<b>AK-1020-10</b>
11,5 cm, 4 <sup>1</sup> / <sub>2</sub> "	<b>AK-1020-11</b>
13,0 cm, 5"	<b>AK-1020-13</b>
14,5 cm, 5 <sup>3</sup> / <sub>4</sub> "	<b>AK-1020-14</b>
15,5 cm, 6"	<b>AK-1020-15</b>
16,5 cm, 6 <sup>1</sup> / <sub>2</sub> "	<b>AK-1020-16</b>
17,5 cm, 6 <sup>5</sup> / <sub>8</sub> "	<b>AK-1020-17</b>
18,5 cm, 7 <sup>1</sup> / <sub>4</sub> "	<b>AK-1020-18</b>
20,0 cm, 8"	<b>AK-1020-20</b>



**DEAVER**

12,0 cm, 4 <sup>3</sup> / <sub>4</sub> "	<b>AK-1021-12</b>
13,0 cm, 5"	<b>AK-1021-13</b>
14,5 cm, 5 <sup>3</sup> / <sub>4</sub> "	<b>AK-1021-14</b>



**DEAVER**

12,0 cm, 4 <sup>3</sup> / <sub>4</sub> "	<b>AK-1022-12</b>
13,0 cm, 5"	<b>AK-1022-13</b>
14,5 cm, 5 <sup>3</sup> / <sub>4</sub> "	<b>AK-1022-14</b>



Präparierscheren  
Dissecting Scissors  
Tijeras de disección  
Forbici per dissezione



**DEAVER**

12,0 cm, 4<sup>3</sup>/<sub>4</sub>" **AK-1023-12**  
13,0 cm, 5" **AK-1023-13**  
14,5 cm, 5<sup>3</sup>/<sub>4</sub>" **AK-1023-14**

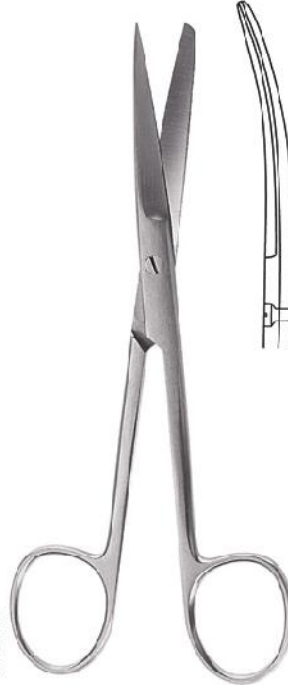

**DEAVER**

12,0 cm, 4<sup>3</sup>/<sub>4</sub>" **AK-1024-12**  
13,0 cm, 5" **AK-1024-13**  
14,5 cm, 5<sup>3</sup>/<sub>4</sub>" **AK-1024-14**



**DEAVER**

12,0 cm, 4<sup>3</sup>/<sub>4</sub>" **AK-1025-12**  
13,0 cm, 5" **AK-1025-13**  
14,5 cm, 5<sup>3</sup>/<sub>4</sub>" **AK-1025-14**

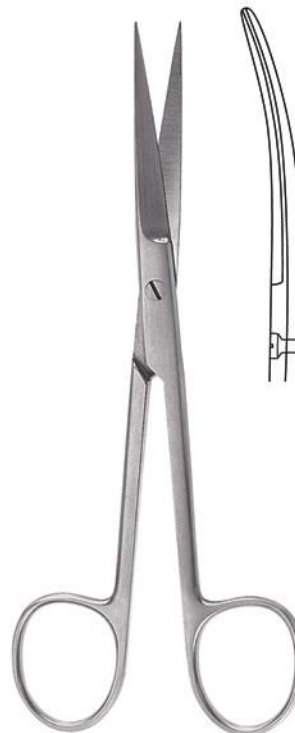

**DEAVER**

12,0 cm, 4<sup>3</sup>/<sub>4</sub>" **AK-1026-12**  
13,0 cm, 5" **AK-1026-13**  
14,5 cm, 5<sup>3</sup>/<sub>4</sub>" **AK-1026-14**

Präparierscheren  
Dissecting Scissors  
Tijeras de disección  
Forbici per dissezione



**GRAZIL**  
13,0 cm, 5" **AK-1027-13**  
14,5 cm, 5<sup>3</sup>/<sub>4</sub>" **AK-1027-14**



**GRAZIL**  
13,0 cm, 5" **AK-1028-13**  
14,5 cm, 5<sup>3</sup>/<sub>4</sub>" **AK-1028-14**



**GRAZIL**  
13,0 cm, 5" **AK-1029-13**  
14,5 cm, 5<sup>3</sup>/<sub>4</sub>" **AK-1029-14**



**GRAZIL**  
13,0 cm, 5" **AK-1030-13**  
14,5 cm, 5<sup>3</sup>/<sub>4</sub>" **AK-1030-14**

Präparierscheren  
Dissecting Scissors  
Tijeras de disección  
Forbici per dissezione



13,0 cm, 5"  
14,5 cm, 5<sup>3</sup>/<sub>4</sub>"

**GRAZIL**  
AK-1031-13  
AK-1031-14



13,0 cm, 5"  
14,5 cm, 5<sup>3</sup>/<sub>4</sub>"

**GRAZIL**  
AK-1032-13  
AK-1032-14

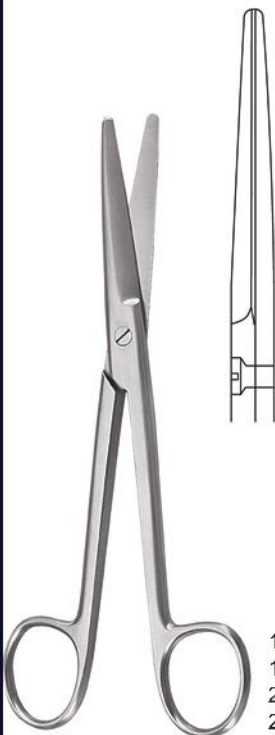

14,5 cm, 5<sup>3</sup>/<sub>4</sub>"  
17,0 cm, 6<sup>3</sup>/<sub>4</sub>"  
23,0 cm, 9"  
28,0 cm, 11"

**MAYO**  
AK-1033-14  
AK-1033-17  
AK-1033-23  
AK-1033-28

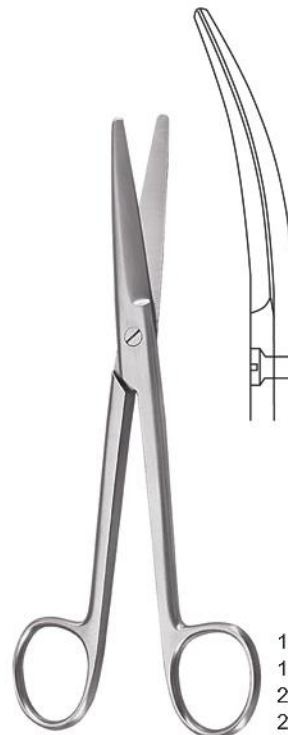

14,5 cm, 5<sup>3</sup>/<sub>4</sub>"  
17,0 cm, 6<sup>3</sup>/<sub>4</sub>"  
23,0 cm, 9"  
28,0 cm, 11"

**MAYO**  
AK-1034-14  
AK-1034-17  
AK-1034-23  
AK-1034-28

Präparierscheren  
Dissecting Scissors  
Tijeras de disección  
Forbici per dissezione



**MAYO-STILE**

15,0 cm, 6"      **AK-1035-15**  
17,0 cm, 6<sup>3</sup>/<sub>4</sub>"      **AK-1035-17**  
19,5 cm, 7<sup>3</sup>/<sub>4</sub>"      **AK-1035-19**  
21,0 cm, 8<sup>1</sup>/<sub>4</sub>"      **AK-1035-21**

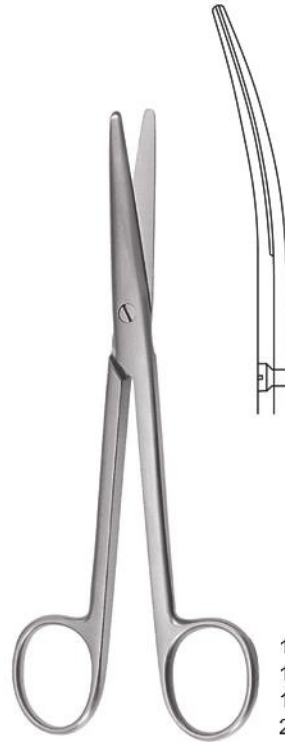

**MAYO-STILE**

15,0 cm, 6"      **AK-1036-15**  
17,0 cm, 6<sup>3</sup>/<sub>4</sub>"      **AK-1036-17**  
19,5 cm, 7<sup>3</sup>/<sub>4</sub>"      **AK-1036-19**  
21,0 cm, 8<sup>1</sup>/<sub>4</sub>"      **AK-1036-21**



**AK-1037-17**



**AK-1038-17**

**MAYO-NOBLE**  
17,0 cm, 6<sup>3</sup>/<sub>4</sub>"



**FOMON**

13,5 cm, 5<sup>3</sup>/<sub>8</sub>"      **AK-1039-13**

Präparierscheren  
Dissecting Scissors  
Tijeras de disección  
Forbici per dissezione



**BABY-METZENBAUM**  
11,5 cm, 4½"



AK-1040-11



AK-1041-11



**METZENBAUM**  
14,5 cm, 5¾"

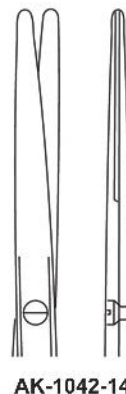

AK-1042-14



AK-1043-14



**METZENBAUM**  
14,5 cm, 5¾"

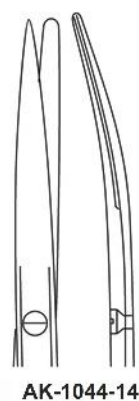

AK-1044-14



**METZENBAUM**  
14,5 cm, 5¾"



AK-1045-14

Präparierscheren  
Dissecting Scissors  
Tijeras de disección  
Forbici per dissezione



**AK-1046-18**  
**AK-1046-20**  
**AK-1046-23**  
**AK-1046-25**  
**AK-1046-28**  
**AK-1046-30**

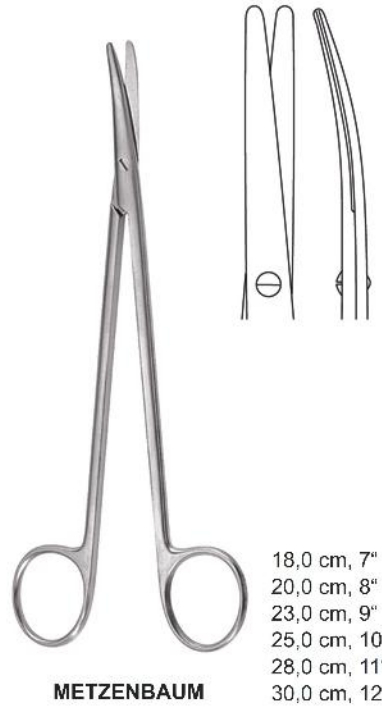

**AK-1047-18**  
**AK-1047-20**  
**AK-1047-23**  
**AK-1047-25**  
**AK-1047-28**  
**AK-1047-30**



**AK-1048-18**  
**AK-1048-20**  
**AK-1048-23**  
**AK-1048-25**  
**AK-1048-28**  
**AK-1048-30**



**AK-1049-18**  
**AK-1049-20**  
**AK-1049-23**  
**AK-1049-25**  
**AK-1049-28**  
**AK-1049-30**

Präparierscheren  
Dissecting Scissors  
Tijeras de disección  
F



**METZENBAUM**

18,0 cm, 7"  
20,0 cm, 8"  
23,0 cm, 9"  
25,0 cm, 10"  
28,0 cm, 11"  
30,0 cm, 12"

**AK-1050-18**  
**AK-1050-20**  
**AK-1050-23**  
**AK-1050-25**  
**AK-1050-28**  
**AK-1050-30**

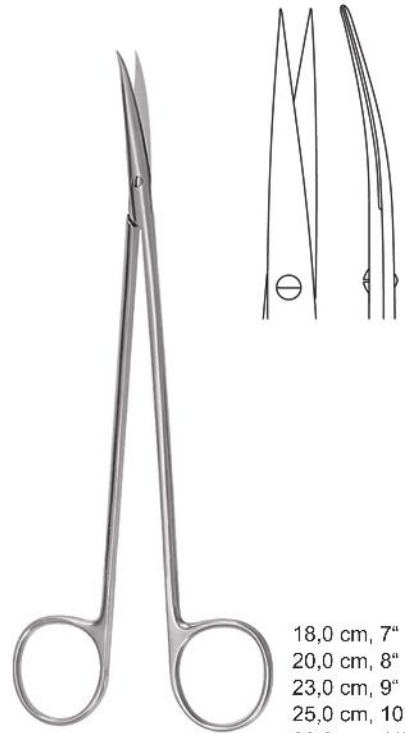

**METZENBAUM**

18,0 cm, 7"  
20,0 cm, 8"  
23,0 cm, 9"  
25,0 cm, 10"  
28,0 cm, 11"  
30,0 cm, 12"

**AK-1051-18**  
**AK-1051-20**  
**AK-1051-23**  
**AK-1051-25**  
**AK-1051-28**  
**AK-1051-30**



**METZENBAUM-FINO**  
14,5 cm, 5<sup>3</sup>/<sub>4</sub>"



**METZENBAUM-FINO**

18,0 cm, 7"  
20,0 cm, 8"  
23,0 cm, 9"  
25,0 cm, 10"  
28,0 cm, 11"  
30,0 cm, 12"

**AK-1054-18**  
**AK-1054-20**  
**AK-1054-23**  
**AK-1054-25**  
**AK-1054-28**  
**AK-1054-30**

Präparierscheren  
Dissecting Scissors  
Tijeras de disección  
Forbici per dissezione

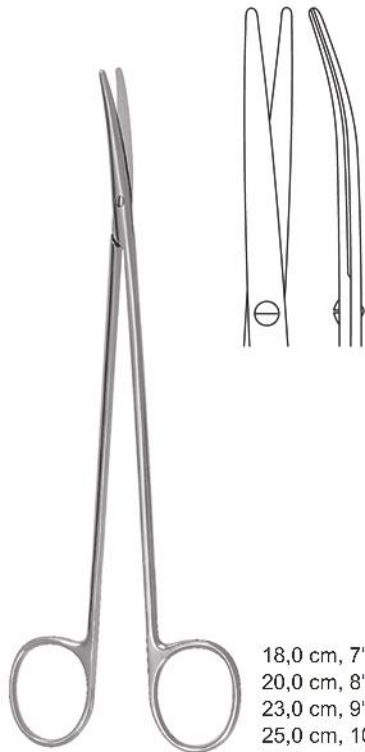

**METZENBAUM-FINO**

18,0 cm, 7"  
20,0 cm, 8"  
23,0 cm, 9"  
25,0 cm, 10"  
28,0 cm, 11"  
30,0 cm, 12"

**AK-1057-18**  
**AK-1057-20**  
**AK-1057-23**  
**AK-1057-25**  
**AK-1057-28**  
**AK-1057-30**



**METZENBAUM-FINO**

14,5 cm, 5<sup>3</sup>/<sub>4</sub>"



**AK-1055-14**



**AK-1056-14**

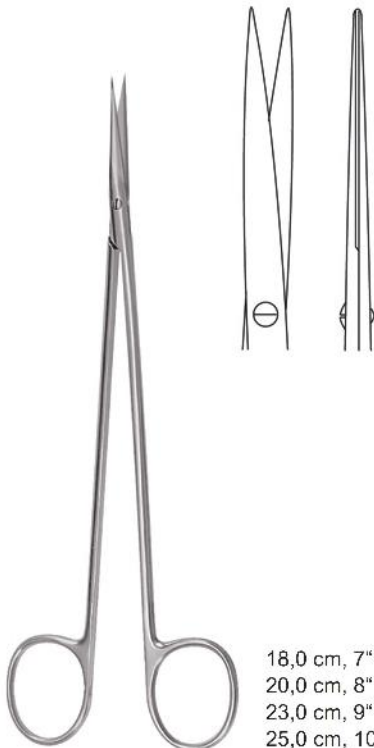

**METZENBAUM-FINO**

18,0 cm, 7"  
20,0 cm, 8"  
23,0 cm, 9"  
25,0 cm, 10"  
28,0 cm, 11"  
30,0 cm, 12"

**AK-1058-18**  
**AK-1058-20**  
**AK-1058-23**  
**AK-1058-25**  
**AK-1058-28**  
**AK-1058-30**

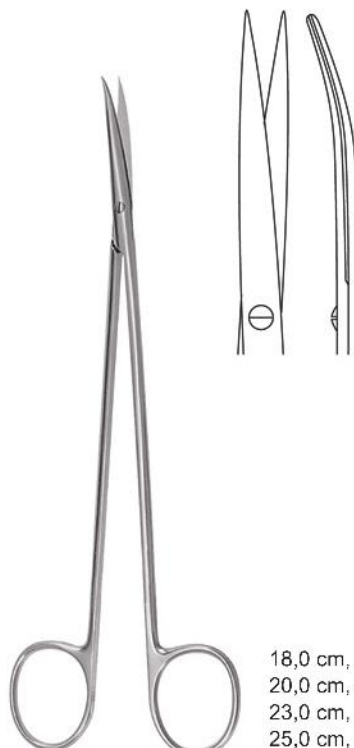

**METZENBAUM-FINO**

18,0 cm, 7"  
20,0 cm, 8"  
23,0 cm, 9"  
25,0 cm, 10"  
28,0 cm, 11"  
30,0 cm, 12"

**AK-1059-18**  
**AK-1059-20**  
**AK-1059-23**  
**AK-1059-25**  
**AK-1059-28**  
**AK-1059-30**



Präparierscheren  
Dissecting Scissors  
Tijeras de disección  
Forbici per dissezione

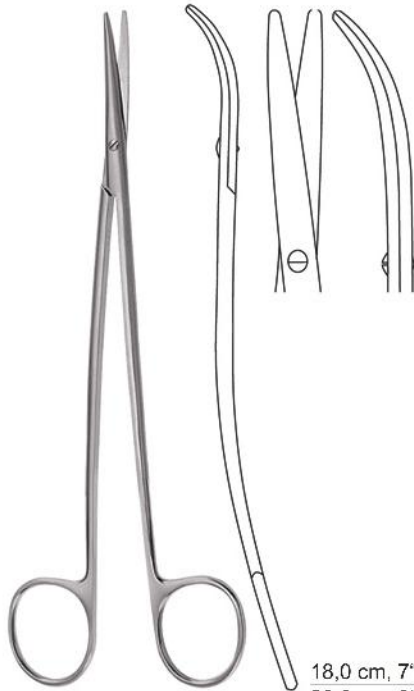

**METZENBAUM-FINO S**

18,0 cm, 7"  
20,0 cm, 8"  
23,0 cm, 9"

**AK-1060-18**  
**AK-1060-20**  
**AK-1060-23**

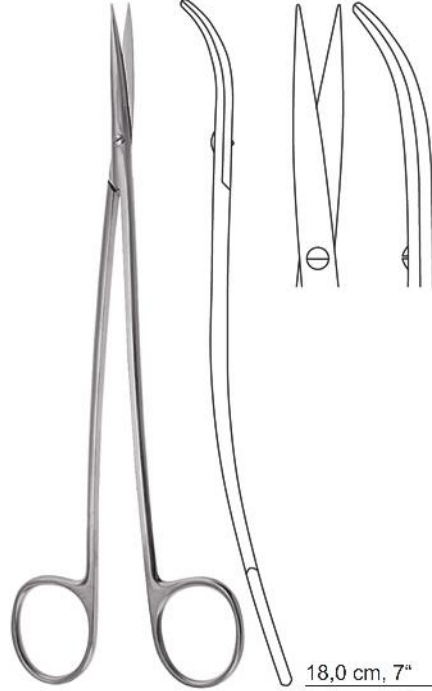

**METZENBAUM-FINOS**

18,0 cm, 7"  
20,0 cm, 8"  
23,0 cm, 9"

**AK-1061-18**  
**AK-1061-20**  
**AK-1061-23**



**METZENBAUM-LAHEY**  
14,0 cm, 5½" **AK-1062-14**

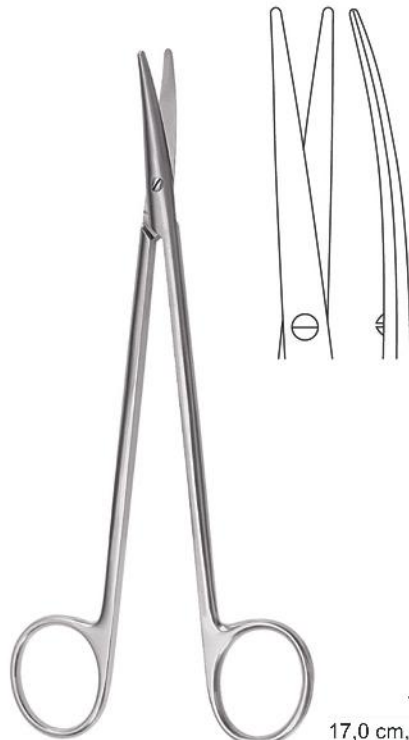

**TOENNIS-ADSON**  
17,0 cm, 6¾" **AK-1063-17**

Präparierscheren  
Dissecting Scissors  
Tijeras de disección  
Forbici per dissezione



**BABY-LEXER**  
10,0 cm, 4"



AK-1064-10



AK-1065-10



**LEXER**

16,0 cm, 6<sup>1</sup>/<sub>4</sub>"

21,0 cm, 8<sup>1</sup>/<sub>4</sub>"

**AK-1066-16**

**AK-1066-21**



**LEXER**

16,0 cm, 6<sup>1</sup>/<sub>4</sub>"

21,0 cm, 8<sup>1</sup>/<sub>4</sub>"

**AK-1069-16**

**AK-1069-21**



**MIXTER**

17,0 cm, 6<sup>3</sup>/<sub>4</sub>"



AK-1067-17



AK-1068-17

Präparierscheren, feine chirurgische Scheren  
 Dissecting Scissors, fine surgical scissors  
 Tijeras de disección, tijeras finas para cirugía  
 Forbici per dissezione, forbici fine per chirurgia



**KILNER (RAGNELL)**

12,0 cm, 4 <sup>3</sup> / <sub>4</sub> "	<b>AK-1070-12</b>
15,0 cm, 6"	<b>AK-1070-15</b>
18,0 cm, 7"	<b>AK-1070-18</b>
20,0 cm, 8"	<b>AK-1070-20</b>



**KILNER (RAGNELL)**

12,0 cm, 4 <sup>3</sup> / <sub>4</sub> "	<b>AK-1071-12</b>
15,0 cm, 6"	<b>AK-1071-15</b>
18,0 cm, 7"	<b>AK-1071-18</b>
20,0 cm, 8"	<b>AK-1071-20</b>



**REYNOLDS**

15,0 cm, 6"	<b>AK-1072-15</b>
18,0 cm, 7"	<b>AK-1072-18</b>



**REYNOLDS**

15,0 cm, 6"	<b>AK-1073-15</b>
18,0 cm, 7"	<b>AK-1073-18</b>
20,0 cm, 8"	<b>AK-1073-20</b>
23,0 cm, 9"	<b>AK-1073-23</b>
25,0 cm, 10"	<b>AK-1073-25</b>

Feine chirurgische Scheren  
Fine surgical scissors  
Tijeras finas para cirugía  
Forbici fine per chirurgia



**THOREK**



19,0 cm, 7 1/2"  
**AK-1074-19**

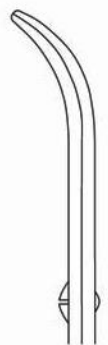

25,0 cm, 10"  
**AK-1075-25**



15,0 cm, 6"



**AK-1076-15**



**AK-1077-15**

Nerv-Präparierscheren  
Nerve dissecting scissors  
Tijeras para nervios  
Forbici per dissezione di nervi



**SANVENERO**  
14,0 cm, 5 1/2"

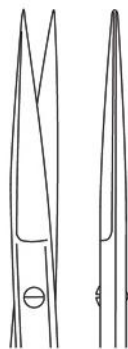

**AK-1078-14**

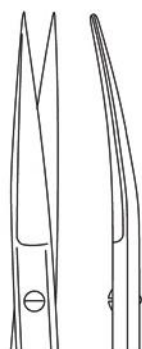

**AK-1079-14**



**JOSEPH**  
14,0 cm, 5 1/2"

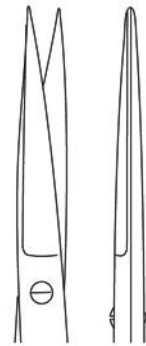

**AK-1080-14**

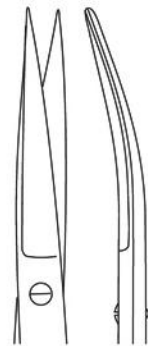

**AK-1081-14**

Feine chirurgische Scheren  
 Fine surgical scissors  
 Tijeras finas para cirugía  
 Forbici fine per chirurgia



**WAGNER**  
 12,0 cm, 4<sup>3</sup>/<sub>4</sub>"



AK-1082-12



AK-1083-12



AK-1086-12



AK-1087-12



**STRABISMUS**  
 11,5 cm, 4<sup>1</sup>/<sub>2</sub>"



AK-1084-11



AK-1085-11

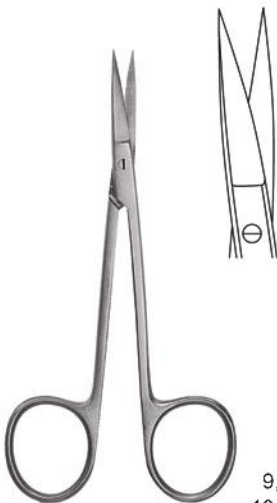

**IRIS**

9,0 cm, 4<sup>1</sup>/<sub>8</sub>"  
 10,5 cm, 4<sup>1</sup>/<sub>8</sub>"  
 11,5 cm, 4<sup>1</sup>/<sub>2</sub>"

**AK-1088-09**  
**AK-1088-10**  
**AK-1088-11**



**IRIS**

9,0 cm, 4<sup>1</sup>/<sub>8</sub>"  
 10,5 cm, 4<sup>1</sup>/<sub>8</sub>"  
 11,5 cm, 4<sup>1</sup>/<sub>2</sub>"

**AK-1089-09**  
**AK-1089-10**  
**AK-1089-11**

Feine chirurgische Scheren  
Fine surgical scissors  
Tijeras finas para cirugía  
Forbici fine per chirurgia



IRIS

10,5 cm, 4<sup>1</sup>/<sub>8</sub>"  
11,5 cm, 4<sup>1</sup>/<sub>2</sub>"

**AK-1090-10**  
**AK-1090-11**



IRIS

10,5 cm, 4<sup>1</sup>/<sub>8</sub>"  
11,5 cm, 4<sup>1</sup>/<sub>2</sub>"

**AK-1091-10**  
**AK-1091-11**



11,5 cm, 4<sup>1</sup>/<sub>2</sub>"  
**AK-1092-11**



11,5 cm, 4<sup>1</sup>/<sub>2</sub>"  
**AK-1093-11**

Feine chirurgische Scheren  
Fine surgical scissors  
Tijeras finas para cirugía  
Forbici fine per chirurgia



12,0 cm, 4<sup>3</sup>/<sub>4</sub>"



AK-1094-12



AK-1095-12



MOD. BONN  
8,0 cm, 3<sup>1</sup>/<sub>4</sub>"  
AK-1096-08



MOD. BONN  
8,0 cm, 3<sup>1</sup>/<sub>4</sub>"  
AK-1097-08



MOD. BONN  
8,0 cm, 3<sup>1</sup>/<sub>4</sub>"  
AK-1098-08



Feine chirurgische Scheren  
 Fine surgical scissors  
 Tijeras finas para cirugía  
 Forbici fine per chirurgia

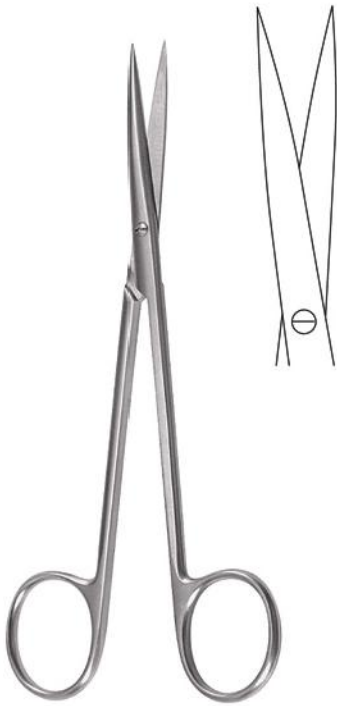

**BROPHY (SULLIVAN)**  
 14,0 cm, 5½"  
 AK-1099-14



**BROPHY (SULLIVAN)**  
 14,0 cm, 5½"  
 AK-1100-14



**LANDOLT**  
 12,5 cm, 5"



**STEVENS**

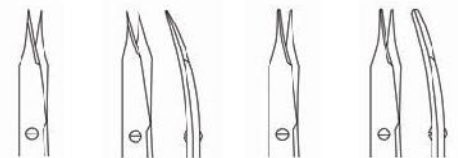

10,5 cm, 4⅛" **AK-1101-10** **AK-1102-10** **AK-1103-10** **AK-1104-10**  
 11,5 cm, 4½" **AK-1101-11** **AK-1102-11** **AK-1103-11** **AK-1104-11**



Chirurgische Scheren  
Surgical scissors  
Tijeras para cirugía  
Forbici per chirurgia



Inzisionsscheren  
Incision scissors  
Tijeras para incisión  
Forbici vascolare e per fistole

13,0 cm, 5"  
14,5 cm, 5<sup>3</sup>/<sub>4</sub>"

**AK-1108-13**  
**AK-1108-14**



Inzisionsscheren  
Incision scissors  
Tijeras para incisión  
Forbici vascolare e per fi stole

**AK-1109-16**  
16,5 cm, 36<sup>1</sup>/<sub>2</sub>"



**RICHTER**  
14,5 cm, 5<sup>3</sup>/<sub>4</sub>"  
**AK-1110-14**



**LAWSON TAIT**  
12,5 cm, 5"  
**AK-1111-12**



**FERGUSON**  
16,5 cm, 6<sup>1</sup>/<sub>4</sub>" **AK-1112-16**  
18,0 cm, 7" **AK-1112-18**

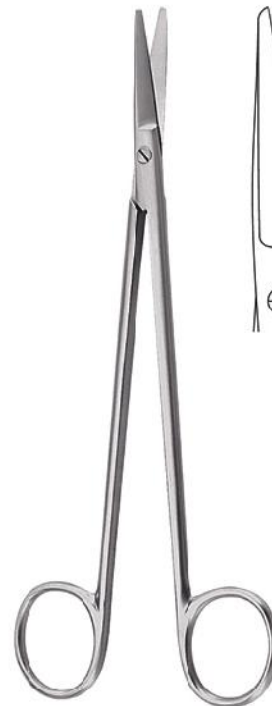

**TOENNIS**  
18,0 cm, 7"  
**AK-1113-18**

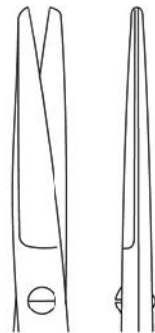

Chirurgische Scheren, Ligaturscheren  
Surgical scissors, Ligature Scissors  
Tijeras para cirugía, Tijeras para ligaduras  
Forbici per chirurgia, Forbici per legature



**TOENNIS**  
18,0 cm, 7"  
AK-1114-18



**HALLE**  
19,0 cm, 7½"  
AK-1115-19



**FOMON**  
15,0 cm, 6"  
AK-1116-15



**SPENCER**  
9,0 cm, 4⅛" AK-1117-09  
10,5 cm, 4⅛" AK-1117-10  
13,0 cm, 5" AK-1117-13



**LITTAUER**  
11,5 cm, 4¼" AK-1118-11  
14,0 cm, 5½" AK-1118-14



**BUCK**

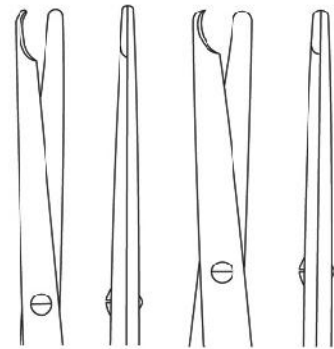

14,5 cm, 5¾"  
AK-1119-14

18,0 cm, 7"  
AK-1120-18

Ligaturscheren, Neurochirurgische Scheren  
 Ligature Scissors, Neurosurgical Scissors  
 Tijeras para ligaduras, Tijeras para Neurocirugia  
 Forbici per legature, Forbici per Neurochirurgia

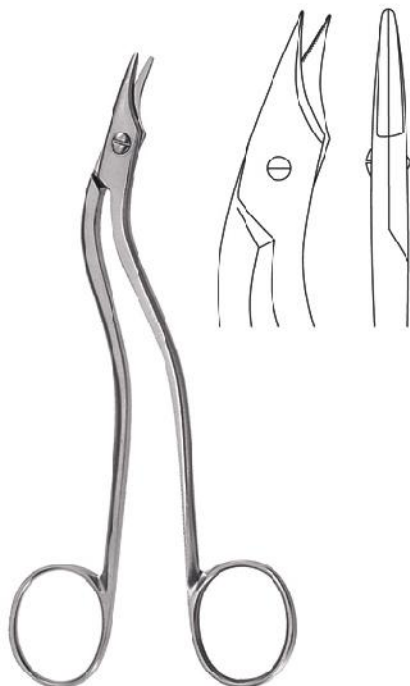

**HEATH**  
 16,0 cm, 6<sup>1</sup>/<sub>4</sub>"  
 AK-1121-16



**NORTHBENT**  
 9,0 cm, 3<sup>1</sup>/<sub>2</sub>"  
 AK-1122-09



**NORTHBENT**  
 13,0 cm, 5"  
 AK-1123-13



**EISELSBERG**  
 12,0 cm, 4<sup>3</sup>/<sub>4</sub>"  
 AK-1124-12

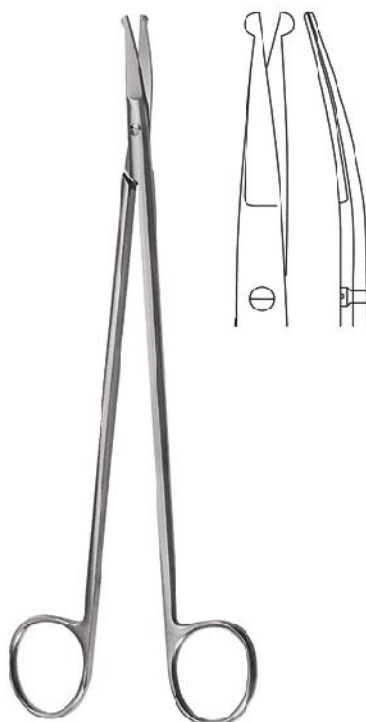

**STRULLY**  
 22,0 cm, 8<sup>5</sup>/<sub>8</sub>"  
 AK-1125-22

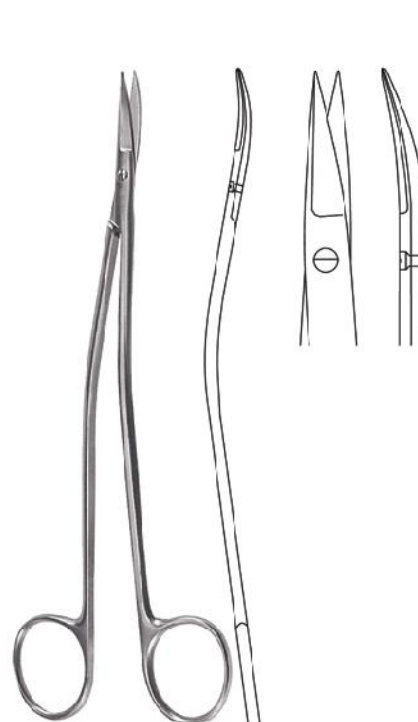

**DANDY**  
 17,0 cm, 6<sup>3</sup>/<sub>4</sub>"  
 AK-1126-17

Neurochirurgische Scheren, Tonsillenscheren, Nasenscheren  
 Neurosurgical Scissors, Tonsil Scissors, Nasal Scissors  
 Tijeras para Neurocirugía, Tijeras para amígdalas, Tijeras para el tabique nasal  
 Forbici per Neurochirurgia, Forbici per tonsille, Forbici per il setto nasale

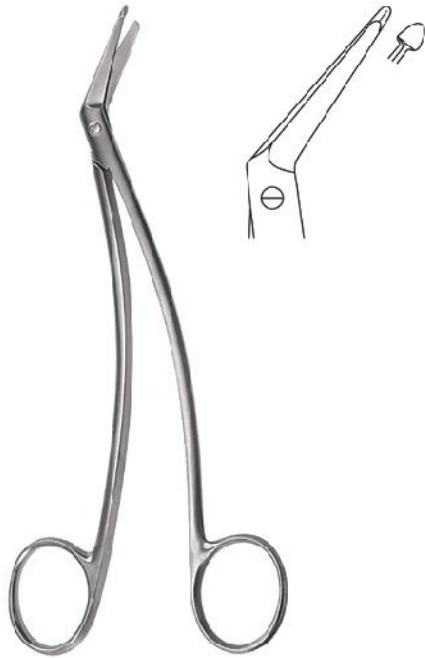

**SCHMIEDEN-TAYLOR**  
 17,0 cm, 6<sup>3</sup>/<sub>4</sub>"  
 AK-1127-17

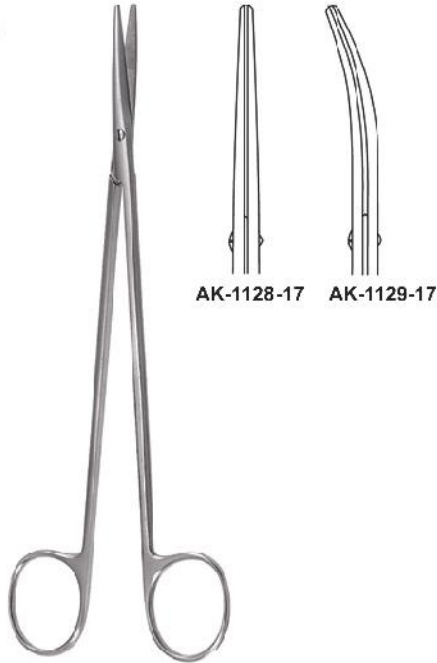

**LINCOLN**  
 17,0 cm, 6<sup>3</sup>/<sub>4</sub>"



**HEYMANN**  
 18,0 cm, 7"  
 AK-1130-18



**COTTLE**  
 16,0 cm, 6<sup>1</sup>/<sub>4</sub>"  
 AK-1131-16



**KIRSTEN**  
 18,0 cm, 7"  
 AK-1132-18



**CAPLAN**  
 22,0 cm, 8<sup>5</sup>/<sub>8</sub>"  
 AK-1133-22

Tonsillenscheren, Nasenscheren, Gefäßscheren  
 Tonsil Scissors, Nasal Scissors, Vascular Scissors  
 Tijeras para amígdalas, Tijeras para el tabique nasal, Tijeras vasculares  
 Forbici per tonsille, Forbici per il setto nasale, Forbici vascolari



**BOETTCHER**  
 18,0 cm, 7"  
 AK-1134-18

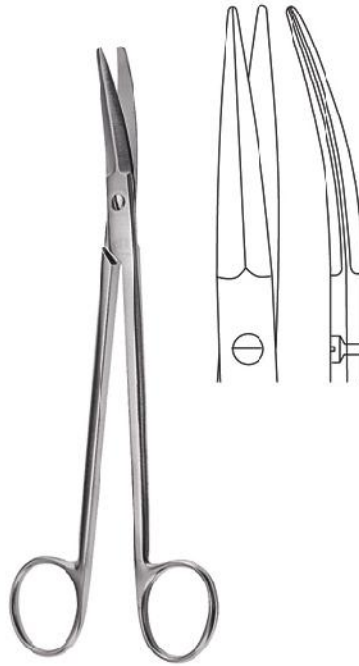

**PRINCE**  
 17,5 cm, 6<sup>5</sup>/<sub>8</sub>"  
 AK-1135-17

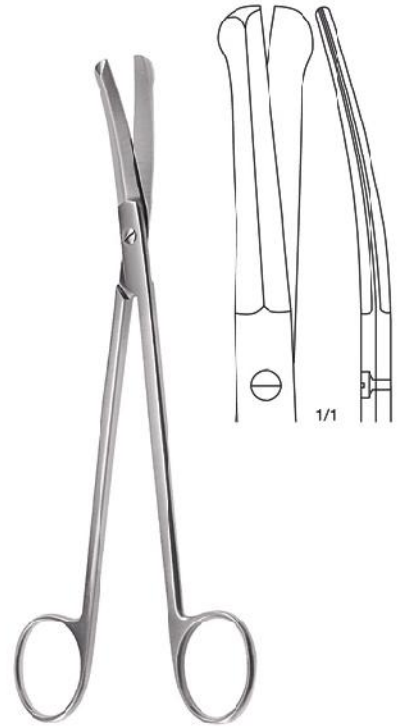

**GOOD**  
 19,0 cm, 7<sup>1</sup>/<sub>2</sub>"  
 AK-1136-19



**CARTILAGE**  
 20,0 cm, 8"  
 AK-1137-20



**DE BAKHEY**

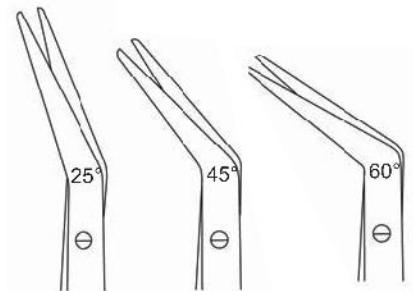

II

17,5 cm, 6 <sup>5</sup> / <sub>8</sub> "	AK-1138-25	AK-1143-45	AK-1148-60
19,5 cm, 7 <sup>3</sup> / <sub>4</sub> "	AK-1139-25	AK-1144-45	AK-1149-60
21,0 cm, 8 <sup>1</sup> / <sub>4</sub> "	AK-1140-25	AK-1145-45	AK-1150-60
23,0 cm, 9"	AK-1141-25	AK-1146-45	AK-1151-60
28,0 cm, 11"	AK-1142-25	AK-1147-45	AK-1152-60

Gefäßscheren  
Vascular Scissors  
Tijeras vasculares  
Forbici vascolari

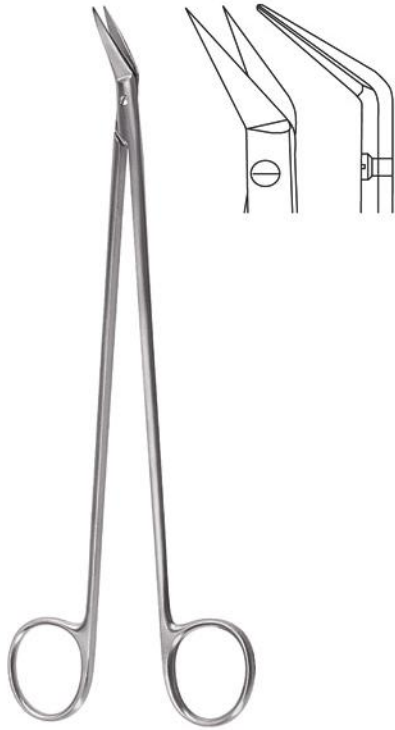

**POTTS-SMITH**  
18,0 cm, 7"  
AK-1143-18

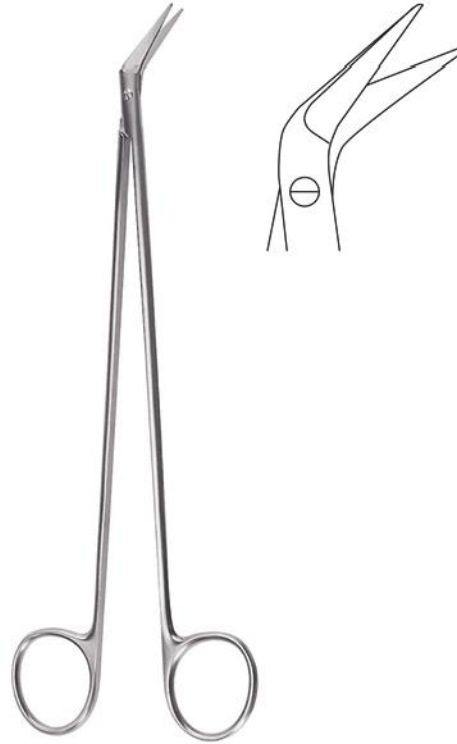

**POTTS DE MARTEL**  
21,0 cm, 8<sup>1</sup>/<sub>4</sub>"    **AK-1144-21**  
24,0 cm, 9<sup>1</sup>/<sub>2</sub>"    **AK-1144-24**



**DIETRICH-HEGEMANN**  
19,0 cm, 7<sup>1</sup>/<sub>2</sub>"

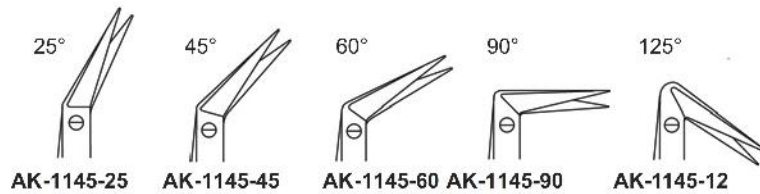

Gefäßscheren  
 Vascular Scissors  
 Tijeras vasculares  
 Forbici vascolari



**DIETRICH**  
 20,0 cm, 7 1/2"  
 AK-1148-12

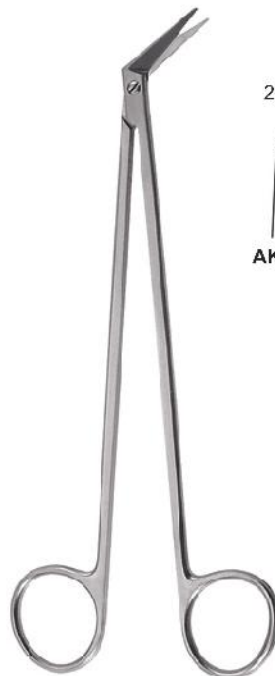

**POTTS-SMITH**  
 19,0 cm, 7 1/2"

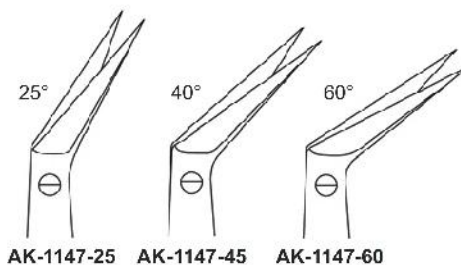

AK-1147-25    AK-1147-45    AK-1147-60

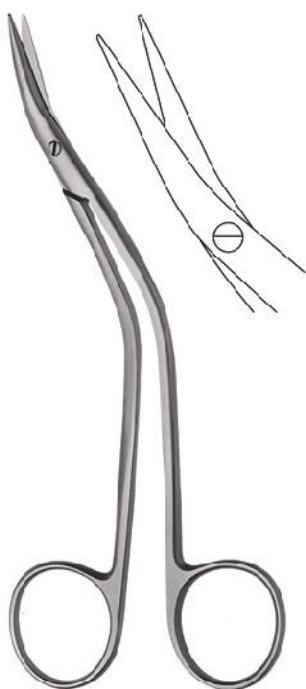

**DE BAKEY**  
 15,5 cm, 6"  
 AK-1149-15

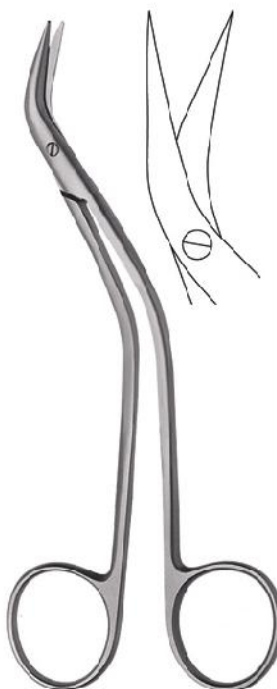

**DE BAKEY**  
 15,5 cm, 6"  
 AK-1150-15



**DE BAKEY**  
 15,5 cm, 6"  
 AK-1151-15

Gefäßscheren, Gynäkologische Scheren  
Vascular Scissors, Gynecology scissors  
Tijeras vasculares, Tijeras para ginecología  
Forbici vascolari, Forbici per ginecologia



**MC INDOE**  
19,0 cm, 7 1/2"  
AK-1152-19



geknöpftes Blatt  
probe-pointed blade  
punta botonada  
lame bottonuta

11,5 cm, 4 1/2"  
AK-1153-11



**CRAFOORD**  
30,0 cm, 12"  
AK-1154-30



**SATINSKY**  
15,5 cm, 9 3/8"  
AK-1155-24

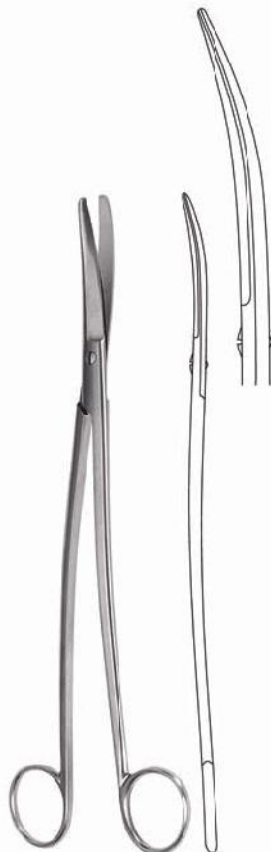

**KLINGENBERG-LOTH**  
23,0 cm, 9"  
AK-1162-23



**SIMS**

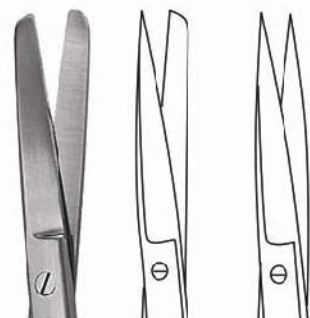

20,0 cm, 8" AK-1156-20 AK-1157-20 AK-1158-20  
23,0 cm, 9" AK-1159-23 AK-1160-23 AK-1161-23



Gynäkologische Scheren  
Gynecology scissors  
Tijeras para ginecología  
Forbici per ginecologia



**SIMS**

20,0 cm, 8"  
23,0 cm, 9"

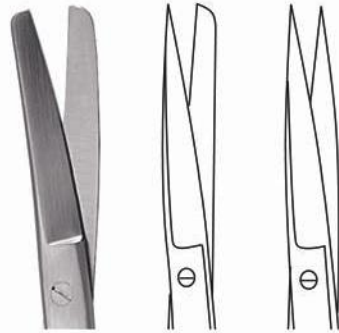

AK-1163-20 AK-1164-20 AK-1165 -20  
AK-1166-23 AK-1167-23 AK-1168 -23



**SIEBOLD**  
24,0 cm, 9 1/2"  
AK-1169-24



**BOZEMANN**  
22,0 cm, 8 3/4"  
AK-1170-22



**DOYEN**

16,0 cm, 6 1/4" AK-1171-16 AK-1172-16 AK- 1173-16  
17,5 cm, 6 3/8" AK-1174-17 AK-1175-17 AK-1176-16



**KELLY**

16,0 cm, 6 1/4" AK-1177-16  
18,0 cm, 7" AK-1177-18

Fistelscheren  
Fistula scissors  
Tijeras para fistulas  
Forbici per fistole

Gynäkologische Scheren, Darmscheren  
Gynecology scissors, Enterotomy Scissors  
Tijeras para ginecología, Tijeras enterótomos  
Forbici per ginecologia, Forbici per enterotomia



Fistelscheren  
Fistula scissors  
Tijeras para fistulas  
Forbici per fistole

**KELLY**

16,0 cm, 6<sup>1</sup>/<sub>4</sub>" **AK-1179-16**  
18,0 cm, 7" **AK-1179-18**



**WERTHEIM**

19,5 cm, 7<sup>3</sup>/<sub>4</sub>" **AK-1180-19**  
22,5 cm, 8<sup>3</sup>/<sub>4</sub>" **AK-1180-23**



**AK-1178-18**

**DUBOIS**

27,0 cm, 10<sup>5</sup>/<sub>8</sub>" **AK-1181-18**



**DARMSCHERE**  
21,0 cm, 8<sup>1</sup>/<sub>4</sub>" **AK-1182-21**



**DARMSCHERE**  
21,0 cm, 8<sup>1</sup>/<sub>4</sub>" **AK-1183-21**



**DARMSCHERE  
GEKNÖPFT**  
21,0 cm, 8<sup>1</sup>/<sub>4</sub>" **AK-1184-21**

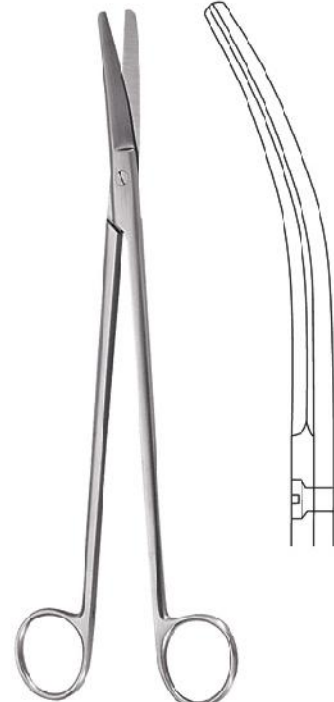

**LLOYD-DAVIES**  
27,0 cm, 10<sup>5</sup>/<sub>8</sub>" **AK-1185-27**

Lungenlappen- und Rektumscheren, Lungenscheren, Dammscheren  
 Lobectomy and Rectal Scissors, Lobectomy Scissors, Episiotomy Scissors  
 Tijeras para lobectomía y recto, Tijera para lobectomía, Tijeras para episiotomía  
 Forbici per lobo polmonare e per il retto, Forbici per lobo, Forbici per episiotomia

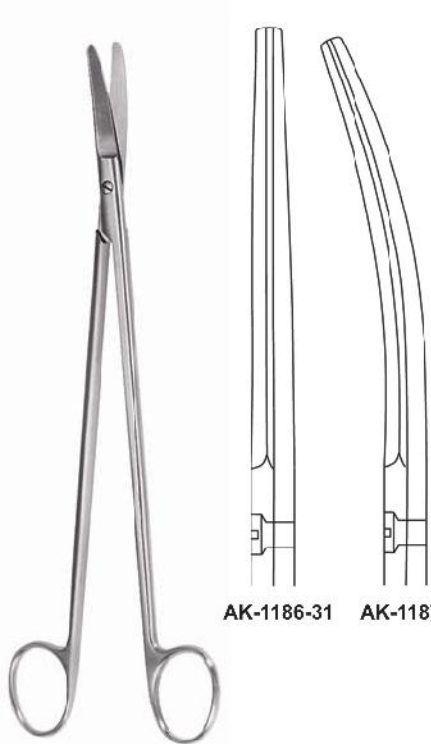

AK-1186-31 AK-1187-31

**STELZNER**  
31,0 cm, 12<sup>3</sup>/<sub>4</sub>"

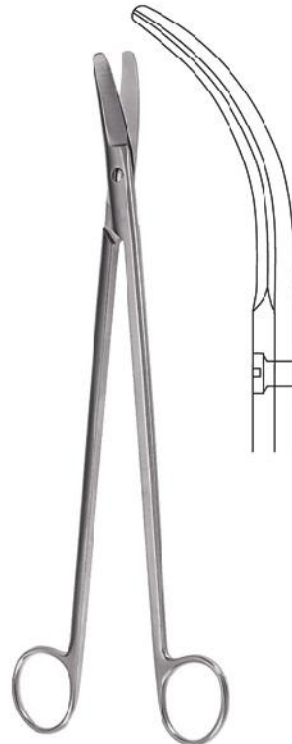

**RECTAL**  
32,5 cm, 12<sup>3</sup>/<sub>4</sub>"  
AK-1188-32

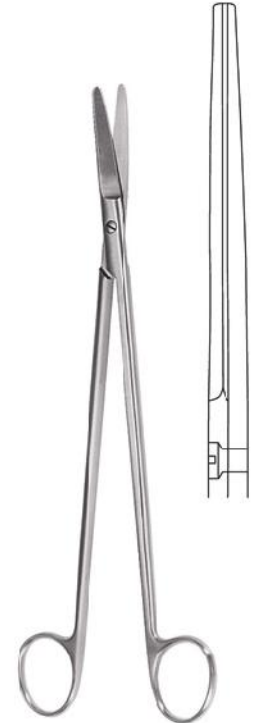

**WILLAUER**  
25,0 cm, 9<sup>3</sup>/<sub>4</sub>" **AK-1189-25**  
28,0 cm, 11" **AK-1189-28**

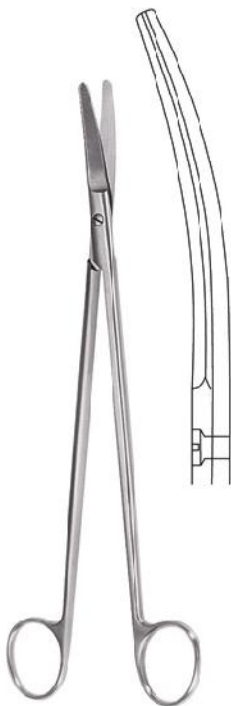

**WILLAUER**  
25,0 cm, 9<sup>3</sup>/<sub>4</sub>" **AK-1190-25**  
28,0 cm, 11" **AK-1190-28**



**POTTS-SMITH**  
19,0 cm, 7<sup>1</sup>/<sub>2</sub>"  
AK-1191-19



**FINOCHIETTO**  
32,5 cm, 10<sup>3</sup>/<sub>8</sub>"  
AK-1192-27

Lungenscheren, Dammscheren, Nabelschnurscheren  
Lobectomy Scissors, Episiotomy Scissors, Umbilical Cord Scissors  
Tijera para lobectomía, Tijeras para episiotomía, Tijeras umbilicales  
Forbici per lobo, Forbici per episiotomia, Forbici ombelicali



**WALDMANN**  
18,0 cm, 7"  
AK-1193-18



**BRAUN-STADLER**  
14,5 cm, 5<sup>3</sup>/<sub>4</sub>"    **AK-1194-14**  
20,0 cm, 8"        **AK-1194-20**



**EPISIOTOMIE SCHERE**  
20,0 cm, 8"  
AK-1195-20



**MOD. USA**  
10,5 cm, 4<sup>1</sup>/<sub>8</sub>"  
AK-1196-10



**BUSCH**  
13,5 cm, 5<sup>3</sup>/<sub>8</sub>"    **AK-1197-13**  
16,0 cm, 6<sup>1</sup>/<sub>4</sub>"    **AK-1197-16**



**SCHUMACHER**  
16,0 cm, 16<sup>1</sup>/<sub>4</sub>"  
AK-1198-16

Drahtscheren, Verband- und Kleiderstoffscheren  
 Wire Scissors, Bandage and Cloth Scissors  
 Cizallas corta-alambres, Tijeras para vendajes y tela  
 Forbici taglia cavo, Forbici per bendaggi e vestiti



gezahnt  
 serrated  
 dentada  
 dentata

**UNIVERSAL**  
 12,0 cm, 4 3/8"



**LISTER**

9,0 cm, 3 1/2"	<b>AK-1199-09</b>
11,0 cm, 4 3/8"	<b>AK-1199-11</b>
14,0 cm, 5 1/2"	<b>AK-1199-14</b>
18,0 cm, 7"	<b>AK-1199-18</b>
20,0 cm, 8"	<b>AK-1199-20</b>



**LISTER**

18,5 cm, 7 1/4"	<b>AK-1201-18</b>
21,0 cm, 8 1/4"	<b>AK-1201-21</b>



**LISTER-EXCENTRIC**

16,0 cm, 6 1/4"	<b>AK-1202-16</b>
19,0 cm, 7 1/2"	<b>AK-1202-19</b>

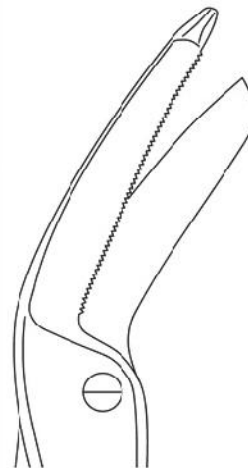

gezahnt  
 serrated  
 dentada  
 dentata



**BERGMANN**

23,0 cm, 9"	<b>AK-1203-23</b>
-------------	-------------------

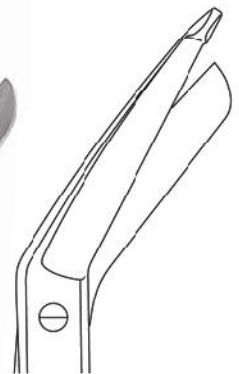

Verband- und Kleiderstoffscheren, Gipsscheren  
 Bandage and Cloth Scissors, Plaster-of-Paris Shears  
 Tijeras para vendajes y tela, Cizallas para escayolas  
 Forbici per bendaggi e vestiti, Cesoie per gessi



**ESMARCH**  
 20,0 cm, 8" **AK-1204-20**  
 22,0 cm, 8<sup>5</sup>/<sub>8</sub>" **AK-1204-22**

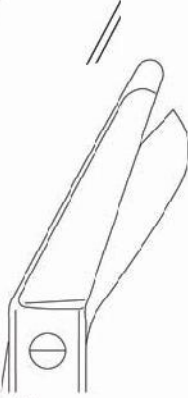

**KNOWLES**  
 14,0 cm, 5<sup>1</sup>/<sub>2</sub>" **AK-1205-14**



gezahnt  
 serrated  
 dentada  
 dentata

**BRUNS**  
 24,0 cm, 9<sup>1</sup>/<sub>2</sub>" **AK-1206-24**  
**AK-1207-24**



**LORENZ**  
 23,0 cm, 9" **AK-1208-23**



**SMITH**  
 (MOD. USA)

16,0 cm, 6<sup>1</sup>/<sub>2</sub>" **AK-1209-16**  
 18,0 cm, 7" **AK-1209-18**  
 20,0 cm, 8" **AK-1209-20**  
 23,0 cm, 9" **AK-1209-23**



**GIPSSCHERE**  
 20,0 cm, 8" **AK-1210-20**

gezahnt  
 serrated  
 dentada  
 dentata



**UNIVERSAL**  
 14,0 cm, 5<sup>1</sup>/<sub>2</sub>" **AK-1211-14**  
 16,0 cm, 6<sup>1</sup>/<sub>4</sub>" **AK-1211-16**  
 18,0 cm, 7" **AK-1211-18**

gezahnt  
 serrated  
 dentada  
 dentata

bis 134°C autoklavierbar  
 autoclavable up to 134°C  
 esterilizable en autoclave hasta 134°C  
 Sterilizzabile in autoclave fino 134°C

Chirurgische Scheren mit Hartmetallschneiden  
 Surgical Scissors with tungsten carbide edges  
 Tijeras para cirugía con filos de carburo tungsteno  
 Forbici per chirurgia con lame in carburo di tungsteno



**STANDARD**  
 14,5 cm, 5<sup>3</sup>/<sub>4</sub>" **AK-1212-14-TC**  
 16,5 cm, 6<sup>1</sup>/<sub>2</sub>" **AK-1212-16-TC**  
 18,5 cm, 7<sup>1</sup>/<sub>2</sub>" **AK-1212-18-TC**



**STANDARD**  
 14,5 cm, 5<sup>3</sup>/<sub>4</sub>" **AK-1213-14-TC**  
 16,5 cm, 6<sup>1</sup>/<sub>2</sub>" **AK-1213-16-TC**  
 18,5 cm, 7<sup>1</sup>/<sub>2</sub>" **AK-1213-18-TC**



**STANDARD**  
 14,5 cm, 5<sup>3</sup>/<sub>4</sub>" **AK-1214-14-TC**  
 16,5 cm, 6<sup>1</sup>/<sub>2</sub>" **AK-1214-16-TC**  
 18,5 cm, 7<sup>1</sup>/<sub>4</sub>" **AK-1214-18-TC**



**STANDARD**  
 14,5 cm, 5<sup>3</sup>/<sub>4</sub>" **AK-1215-14-TC**  
 16,5 cm, 6<sup>1</sup>/<sub>2</sub>" **AK-1215-16-TC**  
 18,5 cm, 7<sup>1</sup>/<sub>4</sub>" **AK-1215-18-TC**



**STANDARD**  
 14,5 cm, 5<sup>3</sup>/<sub>4</sub>" **AK-1216-14-TC**  
 16,5 cm, 6<sup>1</sup>/<sub>2</sub>" **AK-1216-16-TC**  
 18,5 cm, 7<sup>1</sup>/<sub>4</sub>" **AK-1216-18-TC**



**STANDARD**  
 14,5 cm, 5<sup>3</sup>/<sub>4</sub>" **AK-1217-14-TC**  
 16,5 cm, 6<sup>1</sup>/<sub>2</sub>" **AK-1217-16-TC**  
 18,5 cm, 7<sup>1</sup>/<sub>4</sub>" **AK-1217-18-TC**

Chirurgische Scheren mit Hartmetallschneiden  
 Surgical Scissors with tungsten carbide edges  
 Tijeras para cirugía con filos de carburo tungsteno  
 Forbici per chirurgia con lame in carburo di tungsteno



**MAYO**

14,5 cm, 5 <sup>3</sup> / <sub>4</sub> "	<b>AK-1218-14-TC</b>
17,0 cm, 6 <sup>3</sup> / <sub>4</sub> "	<b>AK-1218-17-TC</b>
23,0 cm, 9"	<b>AK-1218-23-TC</b>



**MAYO**

14,5 cm, 5 <sup>3</sup> / <sub>4</sub> "	<b>AK-1219-14-TC</b>
17,0 cm, 6 <sup>3</sup> / <sub>4</sub> "	<b>AK-1219-17-TC</b>
23,0 cm, 9"	<b>AK-1219-23-TC</b>



**MAYO-STILLE**

15,0 cm, 6"	<b>AK-1220-15-TC</b>
17,0 cm, 6 <sup>3</sup> / <sub>4</sub> "	<b>AK-1220-17-TC</b>



**MAYO-STILLE**

15,0 cm, 6"	<b>AK-1221-15-TC</b>
17,0 cm, 6 <sup>3</sup> / <sub>4</sub> "	<b>AK-1221-17-TC</b>



**LEXER**

16,0 cm, 6 <sup>1</sup> / <sub>4</sub> "	<b>AK-1222-16-TC</b>
21,0 cm, 8 <sup>1</sup> / <sub>4</sub> "	<b>AK-1222-21-TC</b>



**LEXER**

16,0 cm, 6 <sup>1</sup> / <sub>4</sub> "	<b>AK-1223-16-TC</b>
21,0 cm, 8 <sup>1</sup> / <sub>4</sub> "	<b>AK-1223-21-TC</b>



Präparierscheren mit Hartmetallschneiden  
 Dissecting Scissors with tungsten carbide edges  
 Tijeras para disección con filos de carburo tungsteno  
 Forbici per dissezione con lame in carburo di tungsteno

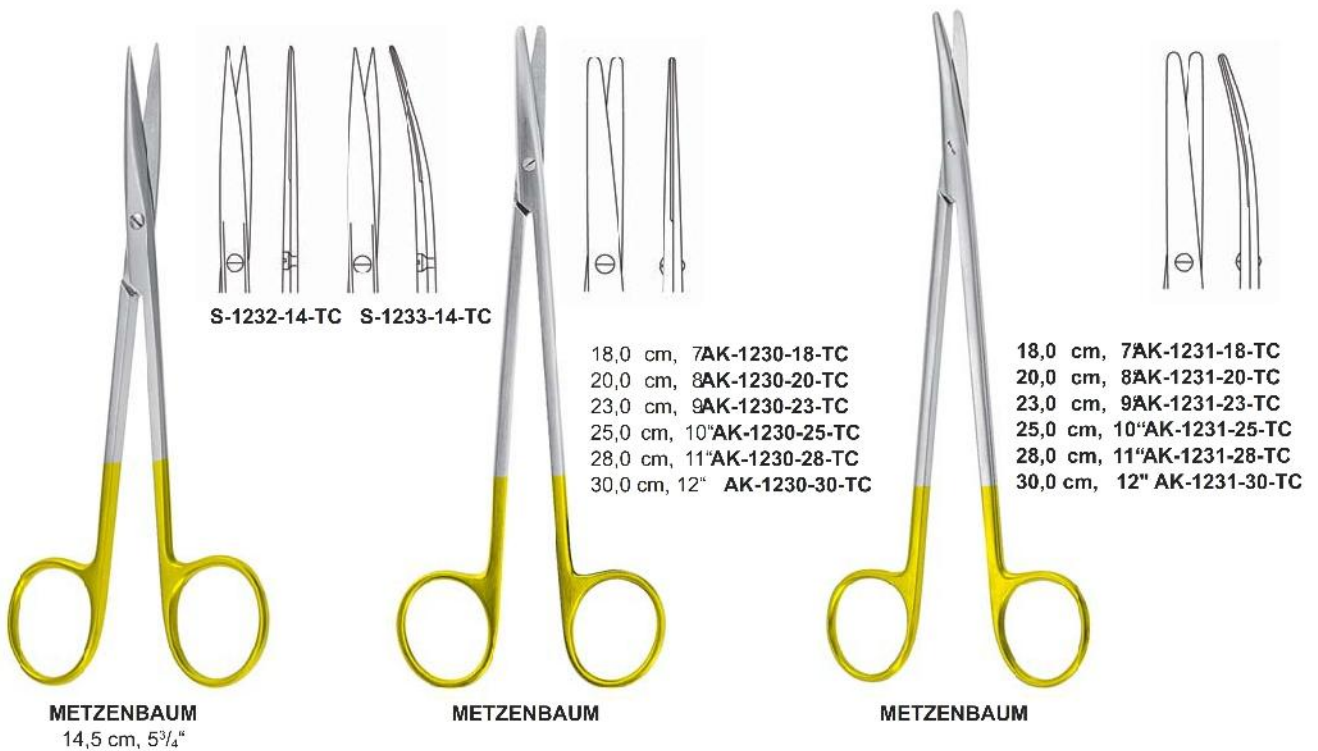
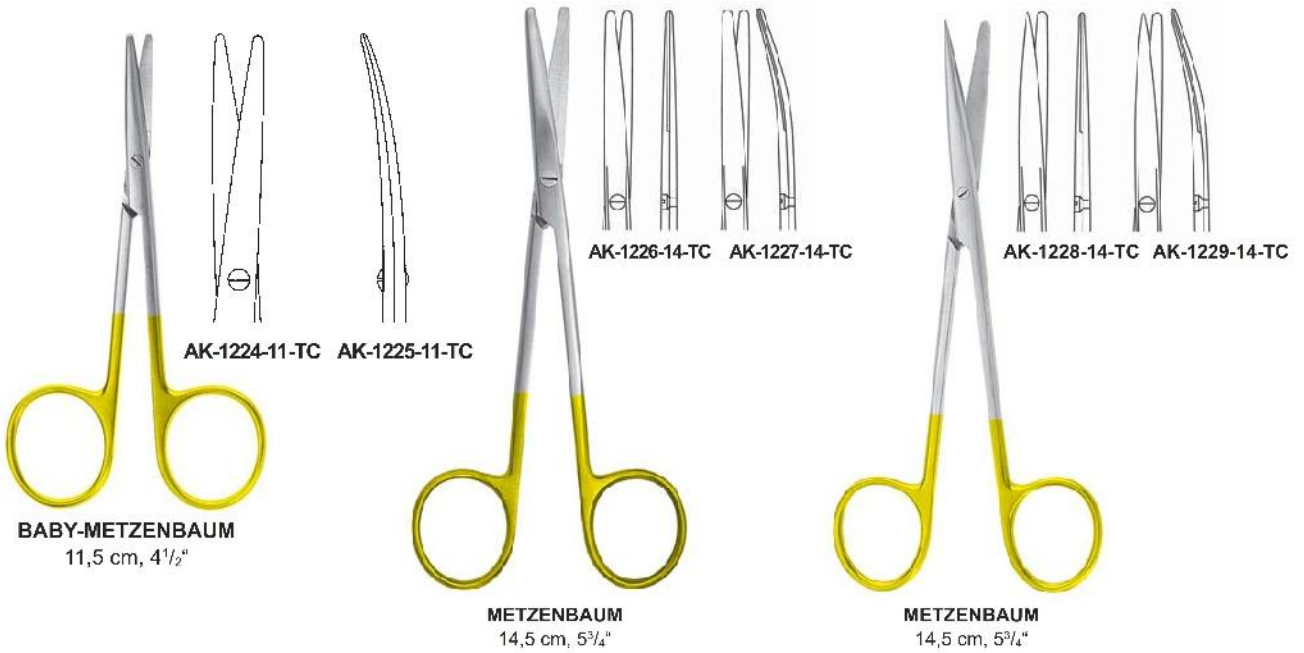



18,0 cm, 7AK-1234-18-TC  
20,0 cm, 8AK-1234-20-TC  
23,0 cm, 9AK-1234-23-TC  
25,0 cm, 10AK-1234-25-TC  
28,0 cm, 11AK-1234-28-TC  
30,0 cm, 12AK-1234-30-TC

**METZENBAUM**

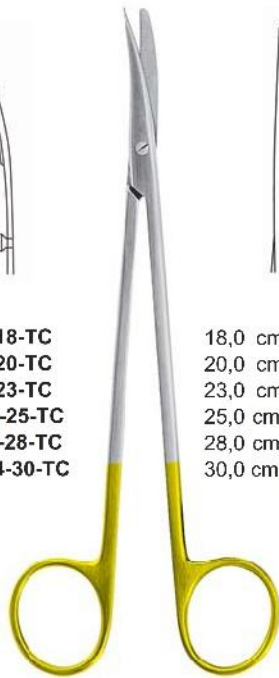

18,0 cm, 7AK-1235-18-TC  
20,0 cm, 8AK-1235-20-TC  
23,0 cm, 9AK-1235-23-TC  
25,0 cm, 10AK-1235-25-TC  
28,0 cm, 11AK-1235-28-TC  
30,0 cm, 12AK-1235-30-TC

**METZENBAUM**

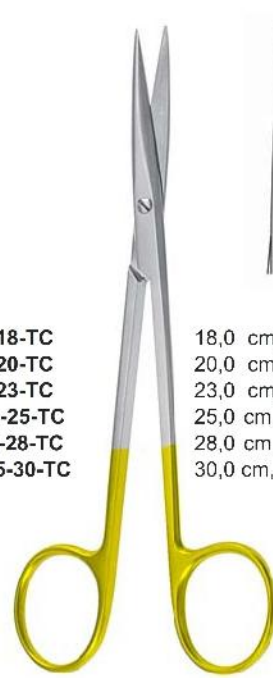

18,0 cm, 7AK-1236-18-TC  
20,0 cm, 8AK-1236-20-TC  
23,0 cm, 9AK-1236-23-TC  
25,0 cm, 10AK-1236-25-TC  
28,0 cm, 11AK-1236-28-TC  
30,0 cm, 12AK-1236-30-TC

**METZENBAUM**



18,0 cm, 7AK-1237-18-TC  
20,0 cm, 8AK-1237-20-TC  
23,0 cm, 9AK-1237-23-TC  
25,0 cm, 10AK-1237-25-TC  
28,0 cm, 11AK-1237-28-TC  
30,0 cm, 12AK-1237-30-TC

**METZENBAUM**



AK-1238-14-TC AK-1239-14-TC

**METZENBAUM-FINO**  
14,5 cm, 5<sup>3</sup>/<sub>4</sub>"



AK-1240-14-TC AK-1241-14-TC

**METZENBAUM-FINO**  
14,5 cm, 5<sup>3</sup>/<sub>4</sub>"

Präparierscheren mit Hartmetallschneiden  
 Dissecting Scissors with tungsten carbide edges  
 Tijeras para disección con filos de carburo tungsteno  
 Forbici per dissezione con lame in carburo di tungsteno

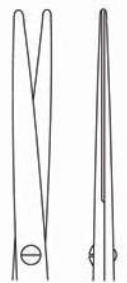

18,0 cm, 7" AK-1242-18-TC  
 20,0 cm, 8" AK-1242-20-TC  
 23,0 cm, 9" AK-1242-23-TC  
 25,0 cm, 10" AK-1242-25-TC  
 28,0 cm, 11" AK-1242-28-TC  
 30,0 cm, 12" AK-1242-30-TC

**METZENBAUM-FINO**

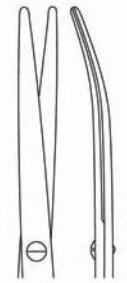
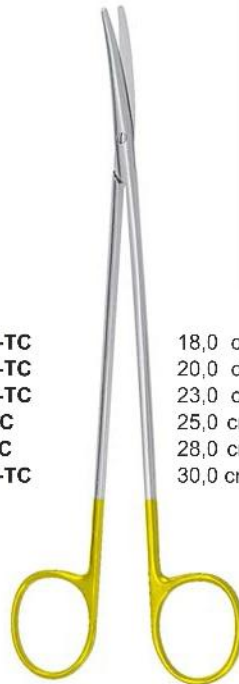

18,0 cm, 7" AK-1243-18-TC  
 20,0 cm, 8" AK-1243-20-TC  
 23,0 cm, 9" AK-1243-23-TC  
 25,0 cm, 10" AK-1243-25-TC  
 28,0 cm, 11" AK-1243-28-TC  
 30,0 cm, 12" AK-1243-30-TC

**METZENBAUM-FINO**

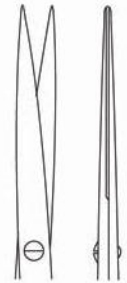
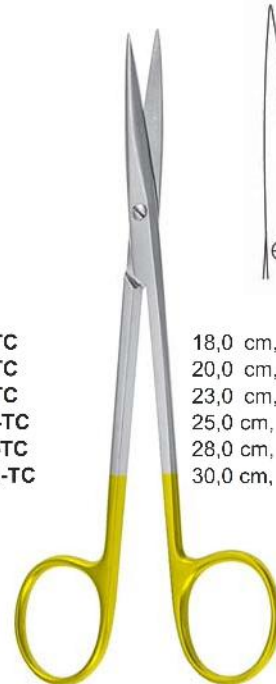

18,0 cm, 7" AK-1244-18-TC  
 20,0 cm, 8" AK-1244-20-TC  
 23,0 cm, 9" AK-1244-23-TC  
 25,0 cm, 10" AK-1244-25-TC  
 28,0 cm, 11" AK-1244-28-TC  
 30,0 cm, 12" AK-1244-30-TC

**METZENBAUM-FINO**

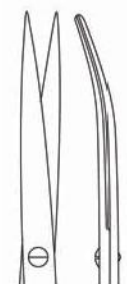

18,0 cm, 7" AK-1245-18-TC  
 20,0 cm, 8" AK-1245-20-TC  
 23,0 cm, 9" AK-1245-23-TC  
 25,0 cm, 10" AK-1245-25-TC  
 28,0 cm, 11" AK-1245-28-TC  
 30,0 cm, 12" AK-1245-30-TC

**METZENBAUM-FINO**



**METZENBAUM-LAHEY**  
 14,0 cm, 5 1/2"  
 AK-1246-14-TC

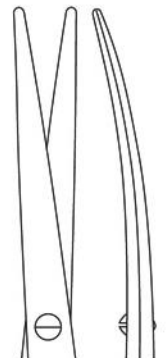

**TOENNIS-ADSON**  
 17,0 cm, 6 3/4"  
 AK-1247-17-TC

Präparierscheren mit Hartmetallschneiden  
Dissecting Scissors with tungsten carbide edges  
Tijeras para disección con filos de carburo tungsteno  
Forbici per dissezione con lame in carburo di tungsteno

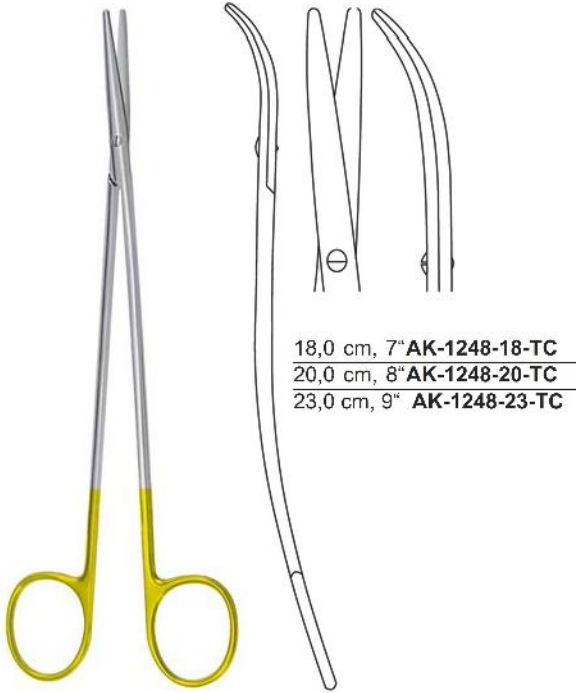

18,0 cm, 7" AK-1248-18-TC  
20,0 cm, 8" AK-1248-20-TC  
23,0 cm, 9" AK-1248-23-TC

**METZENBAUM-FINO S**

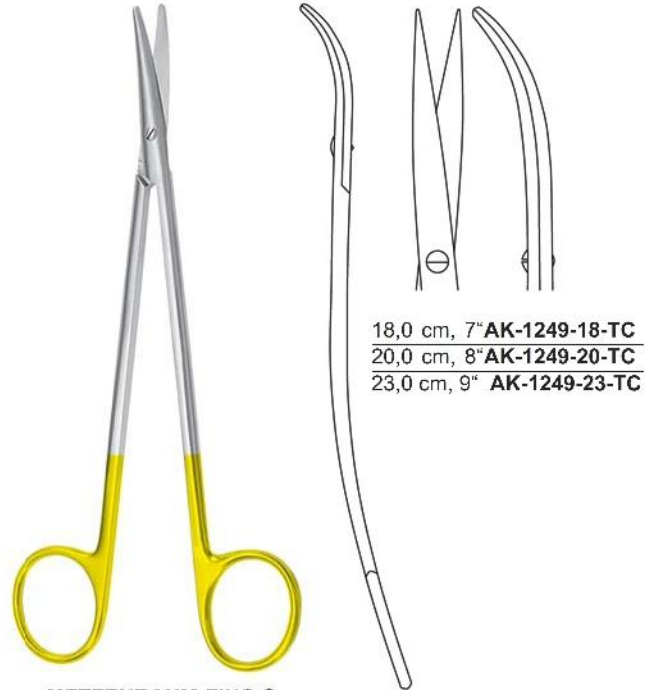

18,0 cm, 7" AK-1249-18-TC  
20,0 cm, 8" AK-1249-20-TC  
23,0 cm, 9" AK-1249-23-TC

**METZENBAUM-FINO S**



**REYNOLDS**  
15,0 cm, 6"  
AK-1250-15-TC



**REYNOLDS**  
15,0 cm, 6"  
AK-1251-15-TC



**HYSTEREKTOMY**  
25,5 cm, 10"  
AK-1252-25-TC



**HYSTEREKTOM Y**  
25,0 cm, 9<sup>3</sup>/<sub>4</sub>"  
AK-1253-25-TC

Gynäkologische Scheren mit Hartmetallschneiden  
 Gynecology Scissors with tungsten carbide edges  
 Tijeras para ginecología con filos de carburo tungsteno  
 Forbici per ginecologia con lame in carburo di tungsteno



SIMS

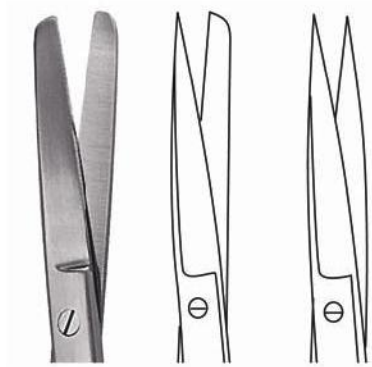

20,0 cm, 8" AK-1254-20-TC AK-1255-20-TC AK-1256-20-TC  
 23,0 cm, 9" AK-1254-23-TC AK-1255-23-TC AK-1256-23-TC



SIMS



20,0 cm, 8" AK-1257-20-TC AK-1258-20-TC AK-1259-20-TC  
 23,0 cm, 9" AK-1257-23-TC AK-1258-23-TC AK-1259-23-TC

Gefäßscheren mit Hartmetallschneiden  
 Vascular Scissors with tungsten carbide edges  
 Tijeras vasculares con filos de carburo tungsteno  
 Forbici vascolari con lame in carburo di tungsteno



**DIETRICH**  
 17,5 cm, 6<sup>5</sup>/<sub>8</sub>"  
 AK-1260-17-TC



**POTTS DE MARTEL**  
 24,0 cm, 9<sup>1</sup>/<sub>2</sub>"  
 AK-1261-24-TC



**DE BAKEY**

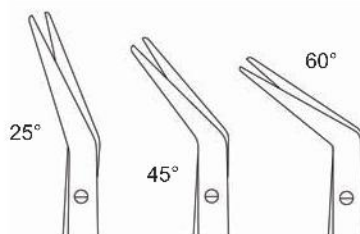

20,0 cm, 8"	<b>AK-1262-25-TC</b>	<b>AK-1264-45-TC</b>	<b>AK-1266-60-TC</b>
23,0 cm, 9"	<b>AK-1263-25-TC</b>	<b>AK-1265-45-TC</b>	<b>AK-1267-60-TC</b>

Gefäßscheren mit Hartmetallschneiden  
 Vascular Scissors with tungsten carbide edges  
 Tijeras vasculares con filos de carburo tungsteno  
 Forbici vascolari con lame in carburo di tungsteno



**DIETRICH-HEGEMANN**  
 18,0 cm, 7"



AK-1268-25-TC    AK-1269-45-TC    AK-1270-60-TC    AK-1271-90-TC    AK-1272-12-TC



**POTTS-SMITH**  
 18,0 cm, 7 1/2"

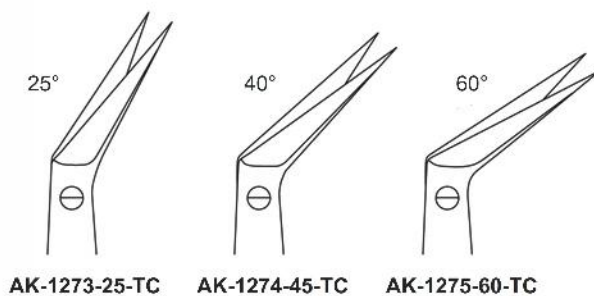

AK-1273-25-TC    AK-1274-45-TC    AK-1275-60-TC

Scheren mit Hartmetallschneiden  
Scissors with tungsten carbide edges  
Tijeras con filos de carburo tungsteno  
Forbici con lame in carburo di tungsteno

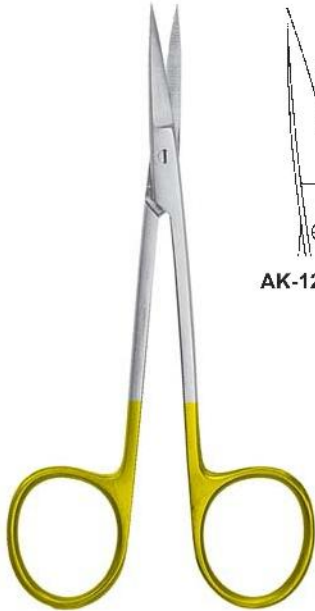

**IRIS**  
11,5 cm, 4 $\frac{1}{2}$ "

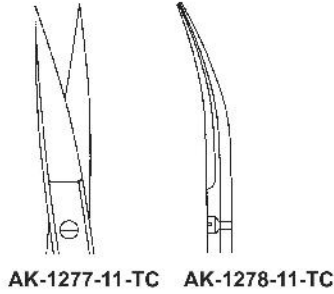

AK-1277-11-TC AK-1278-11-TC



**UNIVERSAL**  
12,0 cm, 4 $\frac{3}{4}$ "  
AK-1279-12-TC

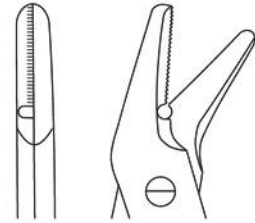

gezahnt  
serrated  
dentada  
dentata

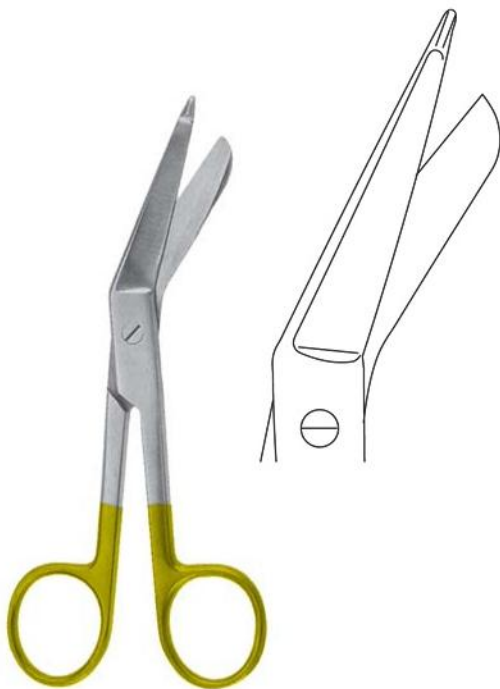

**LISTER**  
18,0 cm, 7"  
AK-1280-18-TC

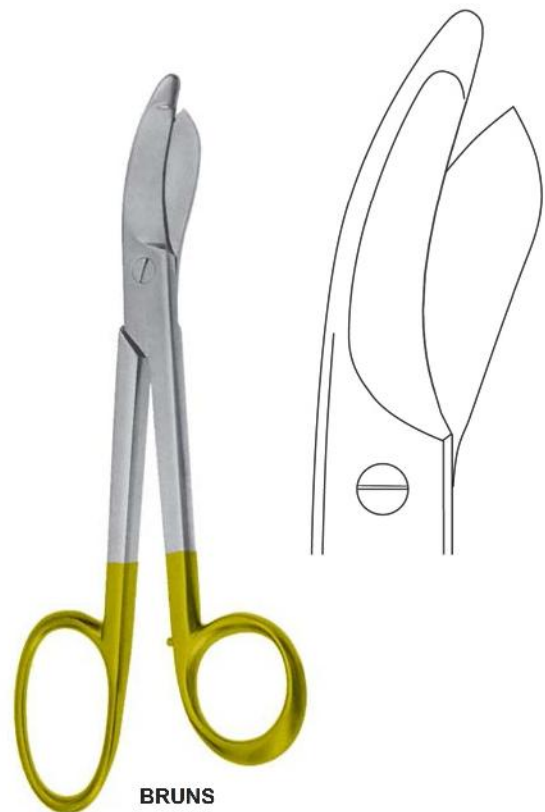
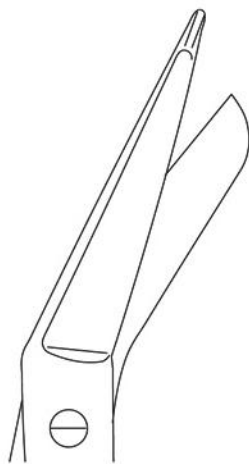

**BRUNS**  
24,0 cm, 9 $\frac{1}{2}$ "  
AK-1281-24-TC

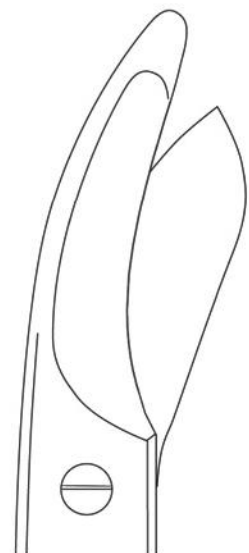



Super-Cut Scheren  
 Super-Cut Scissors  
 Tijeras Super-Cut  
 Forbici Super-Cut



**MAYO**  
 17,0 cm, 6<sup>3</sup>/<sub>4</sub>"

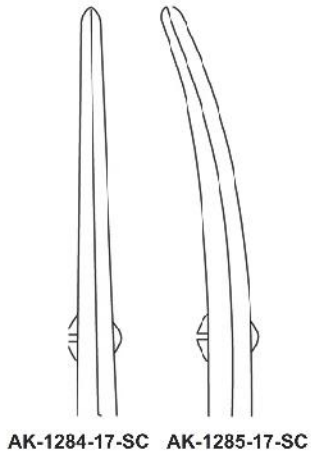

AK-1284-17-SC AK-1285-17-SC



**METZENBAUM**



14,5 cm, 5<sup>3</sup>/<sub>4</sub>" AK-1282-14-SC  
 18,0 cm, 7" AK-1282-18-SC  
 20,0 cm, 8" AK-1282-20-SC  
 23,0 cm, 9" AK-1282-23-SC

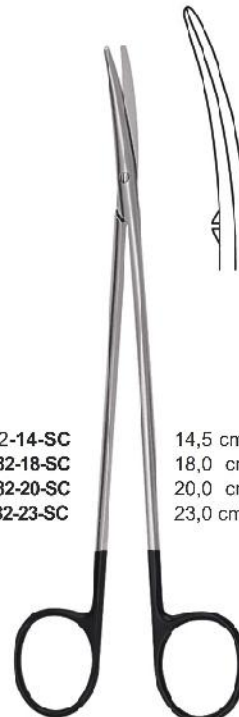

**METZENBAUM-FINO**



14,5 cm, 5<sup>3</sup>/<sub>4</sub>" AK-1283-14-SC  
 18,0 cm, 7" AK-1283-18-SC  
 20,0 cm, 8" AK-1283-20-SC  
 23,0 cm, 9" AK-1283-23-SC



**KAYE FACE LIFT**



15,0 cm, 6" AK-1286-15-SC  
 19,0 cm, 7<sup>1</sup>/<sub>2</sub>" AK-1287-19-SC



**JABALEY**  
 13,0 cm, 5"  
 AK-1288-13-SC



**ENDARTERECTOMY**  
 18,0 cm, 7"  
 AK-1289-18-SC



**TOENNIS-ADSON**  
 17,0 cm, 6<sup>3</sup>/<sub>4</sub>"  
 AK-1290-17-SC

Super-Cut Scheren  
Super-Cut Scissors  
Tijeras Super-Cut  
Forbici Super-Cut



AK-1291-11-SC

AK-1292-11-SC

**STRABISMUS**  
11,5 cm, 4½"



**JAMISON**

15,0 cm, 6" **AK-1293-15-SC**  
18,0 cm, 7" **AK-1293-18-SC**



**REYNOLDS**

12,5 cm, 5" **AK-1294-12-SC**



**BABY-METZENBAUM**

11,0 cm, 4¾" **AK-1295-11-SC**  
14,5 cm, 5¾" **AK-1295-14-SC**



**IRIS**  
11,0 cm, 4¾" **AK-1296-11-SC**



**IRIS**  
11,0 cm, 4¾" **AK-1297-11-SC**



**STEVENS TENOTOMY**  
11,0 cm, 4¾" **AK-1298-11-SC**



**STEVENS TENOTOMY**  
11,0 cm, 4¾" **AK-1299-11-SC**

Super-Cut Scheren  
 Super-Cut Scissors  
 Tijeras Super-Cut  
 Forbici Super-Cut



**PAR TYPE**  
 12,0 cm, 4<sup>3</sup>/<sub>4</sub>"  
**AK-1303-12-SC**



**PAR TYPE**  
 12,0 cm, 4<sup>3</sup>/<sub>4</sub>"  
**AK-1304-12-SC**



**POTTS**  
 19,0 cm, 7<sup>1</sup>/<sub>2</sub>"



**AK-1300-25-SC**



**AK-1301-45-SC**



**AK-1302-60-SC**



**FOMON**  
 14,5 cm, 5<sup>3</sup>/<sub>2</sub>"  
**AK-1305-15-SC**



**COTTLE**  
 16,5 cm, 6<sup>1</sup>/<sub>2</sub>"  
**AK-1306-16-SC**

Mikro-Scheren  
Micro Scissors  
Micro-Tijeras  
Micro-Forbici



**WESTCOTT**  
11,0 cm, 4<sup>3</sup>/<sub>8</sub>"

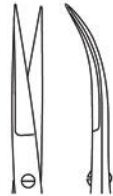

**AK-1307-11-M**

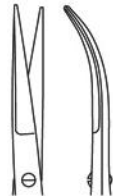

**AK-1308-11-M**



**GOMEL**

14,0 cm, 5<sup>1</sup>/<sub>2</sub>"  
16,0 cm, 6<sup>1</sup>/<sub>4</sub>"

**AK-1312-14-M**  
**AK-1312-16-M**



gezahnt  
serrated  
dentada  
dentata



**HEPP SCHEIDEL**

14,0 cm, 5<sup>1</sup>/<sub>2</sub>"  
16,0 cm, 6<sup>1</sup>/<sub>4</sub>"

**AK-1313-14-M**  
**AK-1313-16-M**



Mikro-Präparierscheren  
Micro-dissecting scissors  
Micro-tijeras de disección  
Micro-forbici per dissezione



18,5 cm, 7<sup>1</sup>/<sub>4</sub>"

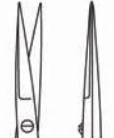

**AK-1309-01-M**

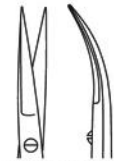

**AK-1310-02-M**



**AK-1311-03-M**



**SIMS**



18,5 cm, 7<sup>1</sup>/<sub>4</sub>" **AK-1314-01** **AK-1315-02** **AK-1316-03** **AK-1318-04**  
22,5 cm, 8<sup>3</sup>/<sub>4</sub>" **AK-1319-01** **AK-1320-02** **AK-1321-03** **AK-1322-04**



18,5 cm, 7<sup>1</sup>/<sub>4</sub>" **AK-1323-01-M** **AK-1325-02-M**  
22,5 cm, 8<sup>3</sup>/<sub>4</sub>" **AK-1324-01-M** **AK-1326-02-M**

Mikro-Scheren, Mikro-Disektionsscheren  
 Micro Scissors, Micro Dissecting Scissors  
 Micro-Tijeras, Micro-Tijeras de disección  
 Micro-Forbici, Micro-Forbici per dissezione



18,0 cm, 7"



AK-1327-25-M

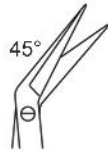

AK-1328-45-M

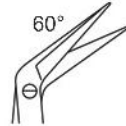

AK-1329-60-M

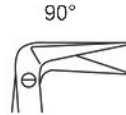

AK-1330-90-M



AK-1331-12-M



AK-1332-25-M



AK-1333-45-M



AK-1334-60-M

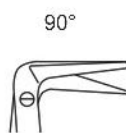

AK-1335-90-M



AK-1336-12-M



15,0 cm, 6"  
AK-1337-15-M



15,0 cm, 6"  
AK-1338-15-M



gezahnt  
serrated  
dentada  
dentata



15,0 cm, 6"  
AK-1339-15-M



18,0 cm, 7"  
AK-1340-18-M

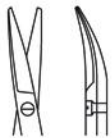

Mikro-Adventitiascheren  
Micro Adventitia Scissors  
Micro-Tijeras Adventitia  
Micro-Forbici Adventitia



15,0 cm, 6"  
AK-1341-15-M



15,0 cm, 6"  
AK-1342-15-M



gezahnt  
serrated  
dentada  
dentata



15,0 cm, 6"  
AK-1343-15-M



18,0 cm, 7"  
AK-1344-18-M

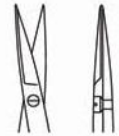



**Pinzetten**  
**Forceps**  
**Pinzas**  
**Pinze**



Anatomische Pinzetten  
Dissecting Forceps  
Pinzas de disección  
Pinze anatomiche per dissezione



schmal  
narrow  
estrechos  
stretti



schmal  
narrow  
estrechos  
stretti



fein  
fine  
finas  
fni

#### STANDARD

10,5 cm, 4 <sup>1</sup> / <sub>8</sub> "	<b>AK-1345-10</b>
11,5 cm, 4 <sup>1</sup> / <sub>2</sub> "	<b>AK-1345-11</b>
13,0 cm, 5"	<b>AK-1345-13</b>
14,5 cm, 5 <sup>3</sup> / <sub>4</sub> "	<b>AK-1345-14</b>
15,0 cm, 6"	<b>AK-1345-15</b>
16,0 cm, 6 <sup>1</sup> / <sub>4</sub> "	<b>AK-1345-16</b>
18,0 cm, 7"	<b>AK-1345-18</b>
20,0 cm, 8"	<b>AK-1345-20</b>
25,0 cm, 10"	<b>AK-1345-25</b>
30,0 cm, 12"	<b>AK-1345-30</b>

#### STANDARD

10,5 cm, 4 <sup>1</sup> / <sub>8</sub> "	<b>AK-1346-10</b>
11,5 cm, 4 <sup>1</sup> / <sub>2</sub> "	<b>AK-1346-11</b>
13,0 cm, 5"	<b>AK-1346-13</b>
14,5 cm, 5 <sup>3</sup> / <sub>4</sub> "	<b>AK-1346-14</b>
15,0 cm, 6"	<b>AK-1346-15</b>
16,0 cm, 6 <sup>1</sup> / <sub>2</sub> "	<b>AK-1346-16</b>
18,0 cm, 7"	<b>AK-1346-18</b>
20,0 cm, 8"	<b>AK-1346-20</b>
25,0 cm, 10"	<b>AK-1346-25</b>
30,0 cm, 12"	<b>AK-1346-30</b>

#### STANDARD

10,5 cm, 4 <sup>1</sup> / <sub>8</sub> "	<b>AK-1347-10</b>
11,5 cm, 4 <sup>1</sup> / <sub>2</sub> "	<b>AK-1347-11</b>
13,0 cm, 5"	<b>AK-1347-13</b>
14,5 cm, 5 <sup>3</sup> / <sub>4</sub> "	<b>AK-1347-14</b>
15,0 cm, 6"	<b>AK-1347-15</b>
16,0 cm, 6 <sup>1</sup> / <sub>4</sub> "	<b>AK-1347-16</b>
18,0 cm, 7"	<b>AK-1347-18</b>
20,0 cm, 8"	<b>AK-1347-20</b>
25,0 cm, 10"	<b>AK-1347-25</b>
30,0 cm, 12"	<b>AK-1347-30</b>

#### STANDARD

10,5 cm, 4 <sup>1</sup> / <sub>8</sub> "	<b>AK-1348-10</b>
11,5 cm, 4 <sup>1</sup> / <sub>2</sub> "	<b>AK-1348-11</b>
13,0 cm, 5"	<b>AK-1348-13</b>
14,5 cm, 5 <sup>3</sup> / <sub>4</sub> "	<b>AK-1348-14</b>
15,0 cm, 6"	<b>AK-1348-15</b>
16,0 cm, 6 <sup>1</sup> / <sub>4</sub> "	<b>AK-1348-16</b>
18,0 cm, 7"	<b>AK-1348-18</b>
20,0 cm, 8"	<b>AK-1348-20</b>
25,0 cm, 10"	<b>AK-1348-25</b>
30,0 cm, 12"	<b>AK-1348-30</b>



Anatomische Pinzetten  
Dissecting Forceps  
Pinzas de disección  
Pinze anatomiche per dissezione



fein  
fine  
finas  
fhi



fein  
fine  
finas  
fhi

mit Stift  
with pin  
con perno  
con espiga



schma  
narrow  
estrec  
stretti



10,5 cm, 4<sup>1</sup>/<sub>8</sub>" **AK-1349-10**  
11,5 cm, 4<sup>1</sup>/<sub>2</sub>" **AK-1349-11**  
13,0 cm, 5" **AK-1349-13**  
14,5 cm, 5<sup>3</sup>/<sub>4</sub>" **AK-1349-14**  
16,0 cm, 6<sup>1</sup>/<sub>4</sub>" **AK-1349-16**  
18,0 cm, 7" **AK-1349-18**  
20,0 cm, 8" **AK-1349-20**  
25,0 cm, 10" **AK-1349-25**  
30,0 cm, 12" **AK-1349-30**

10,5 cm, 4<sup>1</sup>/<sub>8</sub>" **AK-1350-10**  
11,5 cm, 4<sup>1</sup>/<sub>2</sub>" **AK-1350-11**  
13,0 cm, 5" **AK-1350-13**  
14,5 cm, 5<sup>3</sup>/<sub>4</sub>" **AK-1350-14**  
16,0 cm, 6<sup>1</sup>/<sub>4</sub>" **AK-1350-16**  
18,0 cm, 7" **AK-1350-18**  
20,0 cm, 8" **AK-1350-20**  
25,0 cm, 10" **AK-1350-25**  
30,0 cm, 12" **AK-1350-30**

**MOD. USA**

12,0 cm, 4<sup>3</sup>/<sub>4</sub>" **AK-1351-10**  
13,0 cm, 5" **AK-1351-11**  
14,5 cm, 5<sup>3</sup>/<sub>4</sub>" **AK-1351-14**  
15,0 cm, 6" **AK-1351-15**  
18,0 cm, 7" **AK-1351-18**  
20,0 cm, 8" **AK-1351-20**  
25,5 cm, 10" **AK-1351-25**  
30,0 cm, 12" **AK-1351-30**

**MOD. USA**

12,0 cm, 4<sup>3</sup>/<sub>4</sub>" **AK-1352-11**  
13,0 cm, 5" **AK-1352-13**  
14,5 cm, 5<sup>3</sup>/<sub>4</sub>" **AK-1352-14**  
15,0 cm, 6" **AK-1352-15**  
18,0 cm, 7" **AK-1352-18**  
20,0 cm, 8" **AK-1352-20**  
25,5 cm, 10" **AK-1352-25**

Anatomische Pinzetten  
 Dissecting Forceps  
 Pinzas de disección  
 Pinze anatomiche per dissezione



**ADSON**  
 12,0 cm, 4<sup>3</sup>/<sub>4</sub>" **AK-1353-12**  
 15,0 cm, 6" **AK-1353-15**



**MICRO-ADSON**  
 12,0 cm, 4<sup>3</sup>/<sub>4</sub>" **AK-1354-12**  
 15,0 cm, 6" **AK-1354-15**



**STILLE**  
 15,0 cm, 6"  
**AK-1355-15**



**MC INDOE**  
 15,0 cm, 6"  
**AK-1356-15**



**TAYLOR**  
 17,5 cm, 6<sup>5</sup>/<sub>8</sub>"  
**AK-1357-17**



**TAYLOR**  
 17,5 cm, 6<sup>5</sup>/<sub>8</sub>"  
**AK-1358-17**



**TAYLOR**  
 18,5 cm, 7<sup>1</sup>/<sub>4</sub>"  
**AK-1359-18**



**GERALD**  
 18,0 cm, 7"  
**AK-1360-18**

Anatomische Pinzetten  
Dissecting Forceps  
Pinzas de disección  
Pinze anatomiche per dissezione



**GERALD**  
18,0 cm, 7"  
AK-1361-18



**POTTS-SMITH**  
18,0 cm, 7" **AK-1362-18**  
21,0 cm, 8<sup>1</sup>/<sub>4</sub>" **AK-1362-21**  
25,0 cm, 10" **AK-1362-25**

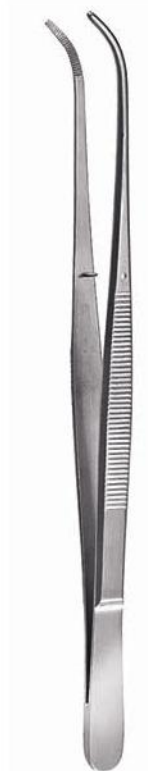

**POTTS-SMITH**  
18,0 cm, 7" **AK-1363-18**  
21,0 cm, 8<sup>1</sup>/<sub>4</sub>" **AK-1363-21**  
25,0 cm, 10" **AK-1363-25**



englische Modelle  
english patterns  
modelos ingleses  
modelli inglese

13,0 cm, 5" **AK-1364-13**  
14,5 cm, 5<sup>3</sup>/<sub>4</sub>" **AK-1364-14**  
15,0 cm, 6" **AK-1364-15**



**SEMKEN**  
12,5 cm, 5" **AK-1365-12**  
15,0 cm, 6" **AK-1365-15**



**CUSHING**  
17,5 cm, 6<sup>5</sup>/<sub>8</sub>"  
**AK-1366-17**



**CUSHING**  
17,5 cm, 6<sup>5</sup>/<sub>8</sub>"  
**AK-1367-17**



**BROPHY**  
20,0 cm, 8"  
**AK-1368-20**

Anatomische Pinzetten  
Dissecting Forceps  
Pinzas de disección  
Pinze anatomiche per dissezione



**BROPHY**  
20,0 cm, 8"  
AK-1369-20



**BONNEY**  
18,0 cm, 7"  
AK-1370-18



**SINGLE-TUTTLE**  
23,0 cm, 9"  
AK-1371-23



**DENNIS BROWN**  
20,0 cm, 8"  
AK-1372-20



**DUEHRSEN**  
20,0 cm, 8"  
AK-1373-20



**WAUGH**  
15,0 cm, 6" AK-1374-15  
20,0 cm, 8" AK-1374-20



**RAMSEY**  
18,0 cm, 7"  
AK-1375-18

Chirurgische Pinzetten  
Tissue Forceps  
Pinzas quirúrgicas  
Pinze per chirurgia

 4 x 5



13,0 cm, 5" **AK-1379-13**  
14,5 cm, 5<sup>3</sup>/<sub>4</sub>" **AK-1379-14**  
16,0 cm, 6<sup>1</sup>/<sub>4</sub>" **AK-1379-16**  
18,0 cm, 7" **AK-1379-18**  
20,0 cm, 8" **AK-1379-20**

 1 x 2



### STANDARD

10,5 cm, 4<sup>1</sup>/<sub>8</sub>" **AK-1376-10**  
11,5 cm, 4<sup>1</sup>/<sub>2</sub>" **AK-1376-11**  
13,0 cm, 5" **AK-1376-13**  
14,5 cm, 5<sup>3</sup>/<sub>4</sub>" **AK-1376-14**  
15,0 cm, 6" **AK-1376-15**  
16,0 cm, 6<sup>1</sup>/<sub>4</sub>" **AK-1376-16**  
18,0 cm, 7" **AK-1376-18**  
20,0 cm, 8" **AK-1376-20**  
25,0 cm, 10" **AK-1376-25**  
30,0 cm, 12" **AK-1376-30**

 2 x 3



11,5 cm, 4<sup>1</sup>/<sub>2</sub>" **AK-1377-11**  
13,0 cm, 5" **AK-1377-13**  
14,5 cm, 5<sup>3</sup>/<sub>4</sub>" **AK-1377-14**  
16,0 cm, 6<sup>1</sup>/<sub>4</sub>" **AK-1377-16**  
18,0 cm, 7" **AK-1377-18**  
20,0 cm, 8" **AK-1377-20**  
25,0 cm, 10" **AK-1377-25**  
30,0 cm, 12" **AK-1377-30**

 3 x 4



13,0 cm, 5" **AK-1378-13**  
14,5 cm, 5<sup>3</sup>/<sub>4</sub>" **AK-1378-14**  
16,0 cm, 6<sup>1</sup>/<sub>4</sub>" **AK-1378-16**  
18,0 cm, 7" **AK-1378-18**  
20,0 cm, 8" **AK-1378-20**

Chirurgische Pinzetten  
Tissue Forceps  
Pinzas quirúrgicas  
Pinze per chirurgia

1 x 2



englische Modelle  
english patterns  
modelos ingleses  
modelli inglese

13,0 cm, 5" **TF-1236-13**  
14,5 cm, 5<sup>3</sup>/<sub>4</sub>" **TF-1236-14**  
15,0 cm, 6" **TF-1236-15**

1 x 2



fein  
fne  
finas  
fni

13,0 cm, 5" **AK-1380-13**  
14,5 cm, 5<sup>3</sup>/<sub>4</sub>" **AK-1380-14**  
15,5 cm, 6" **AK-1380-15**  
16,0 cm, 6<sup>1</sup>/<sub>4</sub>" **AK-1380-16**  
18,0 cm, 7" **AK-1380-18**  
20,0 cm, 8" **AK-1380-20**  
25,0 cm, 10" **AK-1380-25**  
30,0 cm, 12" **AK-1380-30**

1 x 2



mit Stift  
with pin  
con perno  
con espiga

13,0 cm, 5" **TF-1218-13**  
14,5 cm, 5<sup>3</sup>/<sub>4</sub>" **TF-1218-14**  
15,5 cm, 6" **TF-1218-15**  
16,0 cm, 6<sup>1</sup>/<sub>4</sub>" **TF-1218-16**  
18,0 cm, 7" **TF-1218-18**  
20,0 cm, 8" **TF-1218-20**  
25,0 cm, 10" **TF-1218-25**  
30,0 cm, 12" **TF-121-30**

1 x 2



mit Stift  
with pin  
con perno  
con espiga

13,0 cm, 5" **TF-1219-13**  
14,5 cm, 5<sup>3</sup>/<sub>4</sub>" **TF-1219-14**  
16,0 cm, 6<sup>1</sup>/<sub>4</sub>" **TF-1219-16**  
18,0 cm, 7" **TF-1219-18**  
20,0 cm, 8" **TF-1219-20**

Chirurgische Pinzetten  
Tissue Forceps  
Pinzas quirúrgicas  
Pinze per chirurgia



MOD. USA	
12,0 cm, 4 <sup>3</sup> / <sub>4</sub> "	TF-1206-12
13,0 cm, 5"	TF-1206-13
14,5 cm, 5 <sup>3</sup> / <sub>4</sub> "	TF-1206-14
15,5 cm, 6"	TF-1206-15
18,0 cm, 7"	TF-1206-18
20,0 cm, 8"	TF-1206-20
25,0 cm, 10"	TF-1206-25
30,0 cm, 12"	TF-1206-30



MOD. USA	
12,0 cm, 4 <sup>3</sup> / <sub>4</sub> "	TF-1212-12
13,0 cm, 5"	TF-1212-13
14,5 cm, 5 <sup>3</sup> / <sub>4</sub> "	TF-1212-14
15,5 cm, 6"	TF-1212-15
18,0 cm, 7"	TF-1212-18
20,0 cm, 8"	TF-1212-20
25,0 cm, 10"	TF-1212-25
30,0 cm, 12"	TF-1212-30



ADSON	
12,0 cm, 4 <sup>3</sup> / <sub>4</sub> "	TF-1270-12
15,0 cm, 6"	TF-1270-15



MICRO-ADSON	
12,0 cm, 4 <sup>3</sup> / <sub>4</sub> "	TF-1276-12
15,0 cm, 6"	TF-1276-15

Chirurgische Pinzetten  
Tissue Forceps  
Pinzas quirúrgicas  
Pinze per chirurgia

2 x 3



**ADSON**  
12,0 cm, 4<sup>3</sup>/<sub>4</sub>" TF-1074-12  
15,0 cm, 6" TF-1074-15

1 x 2



**ADSON-BROWN**  
12,0 cm, 4<sup>3</sup>/<sub>4</sub>" TF-1288-12  
15,0 cm, 6" TF-1288-15



**ADSON**  
12,0 cm, 4<sup>3</sup>/<sub>4</sub>" TF-1282-12

1 x 2



**STILLE**  
15,0 cm, 6" TF-1208-15

2 x 3



**STILLE**  
15,0 cm, 6" TF-1209-15

1 x 2



**GILLIES**  
15,0 cm, 6" TF-1300-15

2 x 3



**ADLERKREUTZ**  
15,0 cm, 6" TF-1382-15  
20,0 cm, 8" TF-1382-20

4 x 5



**ADLERKREUTZ**  
15,0 cm, 6" TF-1384-15  
20,0 cm, 8" TF-1384-20



Chirurgische Pinzetten  
Tissue Forceps  
Pinzas quirúrgicas  
Pinze per chirurgia

1 x 2



**SEMKEN**  
12,5 cm, 5" **TF-1240-12**  
15,5 cm, 6" **TF-1240-15**

2 x 3



**SEMKEN**  
12,5 cm, 5" **TF-1242-12**

1 x 2



**MC INDOE**  
15,0 cm, 6" **TF-1358-15**

1 x 2



**TAYLOR**  
17,5 cm, 6<sup>5</sup>/<sub>8</sub>" **TF-1314-17**

1 x 2



**TAYLOR**  
17,5 cm, 6<sup>5</sup>/<sub>8</sub>" **TF-1315-17**

1 x 2



**TAYLOR**  
17,5 cm, 6<sup>5</sup>/<sub>8</sub>" **TF-1317-17**

1 x 2



**GERALD**  
18,0 cm, 7" **TF-1302-18**

1 x 2



**GERALD**  
18,0 cm, 7" **TF-1303-18**

Chirurgische Pinzetten  
Tissue Forceps  
Pinzas quirúrgicas  
Pinze per chirurgia

1 x 2



**CUSHING**  
17,5 cm, 6<sup>5</sup>/<sub>8</sub>"  
TF-1292-17

1 x 2



**CUSHING**  
17,5 cm, 6<sup>5</sup>/<sub>8</sub>"  
TF-1293-17

1 x 2



18,0 cm, 7"  
21,0 cm, 8<sup>1</sup>/<sub>4</sub>"  
25,0 cm, 10" **TF-1226-18**  
**TF-1226-21**  
**TF-1226-25**

1 x 2



**POTTS-SMITH**  
18,0 cm, 7" **TF-1227-18**  
21,0 cm, 8<sup>1</sup>/<sub>4</sub>" **TF-1227-21**  
25,0 cm, 10" **TF-1227-25**

x 2



**WAUGH**  
15,0 cm, 6" **TF-1330-15**  
20,0 cm, 8" **TF-1330-20**

1 x 2



**BROPHY**  
20,0 cm, 8"  
TF-1294-20

1 x 2



**BROPHY**  
20,0 cm, 8"  
TF-1295-20



**RUSS. MODELL**  
15,0 cm, 6" **TF-1456-15**  
20,0 cm, 8" **TF-1456-20**  
25,0 cm, 10" **TF-1456-25**

Chirurgische Pinzetten  
Tissue Forceps  
Pinzas quirúrgicas  
Pinze per chirurgia



**DURANTE**  
14,5 cm, 5<sup>3</sup>/<sub>4</sub>" **TF-1460-14**  
16,0 cm, 6<sup>1</sup>/<sub>4</sub>" **TF-1460-16**  
20,0 cm, 8" **TF-1460-20**



**DUEHRSEN**  
20,0 cm, 8"

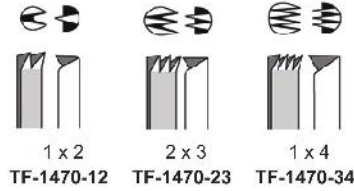

**NELSON**  
15,0 cm, 6" **TF-1518-15**  
20,0 cm, 8" **TF-1518-20**  
23,0 cm, 9" **TF-1518-23**



**DUVAL**  
14,0 cm, 5<sup>1</sup>/<sub>2</sub>"

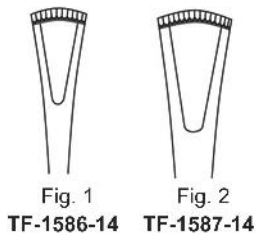

**COLLIN-DUVAL**  
20,0 cm, 8"

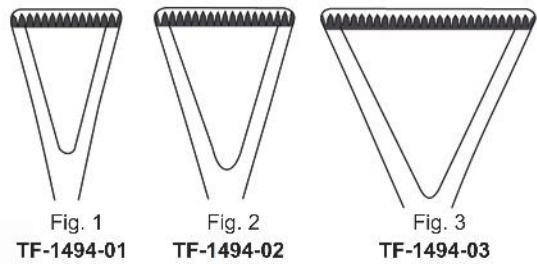

Chirurgische Pinzetten  
Tissue Forceps  
Pinzas quirúrgicas  
Pinze per chirurgia

1 x 2



**LANE**

14,5 cm, 5<sup>3</sup>/<sub>4</sub>" TF-1420-14  
20,0 cm, 8" TF-1420-20

2 x 3



**LANE**

14,5 cm, 5<sup>3</sup>/<sub>4</sub>" TF-1422-14  
20,0 cm, 8" TF-1422-20

7 x 7



**BROWN**

15,0 cm, 6" TF-1410-15  
20,0 cm, 8" TF-1410-20  
25,0 cm, 10" TF-1410-25

1 x 2



**TREVES**

13,0 cm, 5" TF-1510-13  
15,0 cm, 6" TF-1510-15

1 x 2

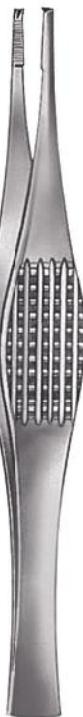

**RAMSEY**  
18,0 cm, 7"  
TF-1520-18

2 x 3

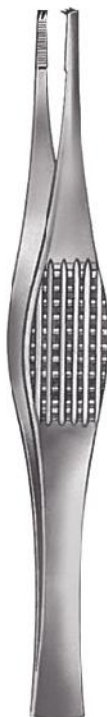

**RAMSEY**  
18,0 cm, 7"  
TF-1522-18

1 x 2



**RAMSEY**  
18,0 cm, 7"  
TF-1590-18

2 x 3



**RAMSEY**  
18,0 cm, 7"  
TF-1592-18

Splitterpinzetten  
Splinter Forceps  
Pinzas para espinas  
Pinze per schegge

gerieft



gebogen  
gerieft



mit Stift



mit Stift  
gebogen  
gerieft



8,0 cm, 3<sup>1</sup>/<sub>4</sub>" **SF-1662-08**  
9,0 cm, 3<sup>1</sup>/<sub>2</sub>" **SF-1662-09**  
10,5 cm, 4<sup>1</sup>/<sub>8</sub>" **SF-1662-10**  
11,5 cm, 4<sup>1</sup>/<sub>2</sub>" **SF-1662-11**  
13,0 cm, 5" **SF-1662-13**  
14,5 cm, 5<sup>1</sup>/<sub>2</sub>" **SF-1662-14**

8,0 cm, 3<sup>1</sup>/<sub>4</sub>" **SF-1663-08**  
9,0 cm, 3<sup>1</sup>/<sub>2</sub>" **SF-1663-09**  
10,5 cm, 4<sup>1</sup>/<sub>8</sub>" **SF-1663-10**  
11,5 cm, 4<sup>1</sup>/<sub>2</sub>" **SF-1663-11**  
13,0 cm, 5" **SF-1663-13**  
14,5 cm, 5<sup>1</sup>/<sub>2</sub>" **SF-1663-14**

8,0 cm, 3<sup>1</sup>/<sub>4</sub>" **SF-1666-08**  
9,0 cm, 3<sup>1</sup>/<sub>2</sub>" **SF-1666-09**  
10,5 cm, 4<sup>1</sup>/<sub>8</sub>" **SF-1666-10**  
11,5 cm, 4<sup>1</sup>/<sub>2</sub>" **SF-1666-11**  
13,0 cm, 5" **SF-1666-13**  
14,5 cm, 5<sup>1</sup>/<sub>2</sub>" **SF-1666-14**

8,0 cm, 3<sup>1</sup>/<sub>4</sub>" **016-1667-08**  
9,0 cm, 3<sup>1</sup>/<sub>2</sub>" **016-1667-09**  
10,5 cm, 4<sup>1</sup>/<sub>8</sub>" **016-1667-10**  
11,5 cm, 4<sup>1</sup>/<sub>2</sub>" **016-1667-11**  
13,0 cm, 5" **016-1667-13**  
14,5 cm, 5<sup>1</sup>/<sub>2</sub>" **016-1667-14**

Splitterpinzetten, Mikro-Pinzetten  
 Splinter Forceps, Micro Forceps  
 Pinzas para espinas, Pinzas para microscopia  
 Pinze per schegge, Pinze per microscopia



**HUNTER**  
 10,5 cm, 4 1/4"  
**SF-1652-10**



**HUNTER**  
 10,5 cm, 4 1/4"  
**SF-1653-10**



**WALTER-CARMALT**  
 10,5 cm, 4 1/4"  
**SF-1656-10**



**WALTER-CARMALT**  
 10,5 cm, 4 1/4"  
**SF-1657-10**



**FEILCHENFELD**  
 7,5 cm, 3 1/8" **SF-1650-07**  
 9,0 cm, 3 1/2" **SF-1650-09**  
 11,5 cm, 4 1/2" **SF-1650-11**



10,0 cm, 4"  
**SF-1806-10**



10,0 cm, 4"  
**SF-1807-10**



10,0 cm, 4"  
**SF-1809-10**  
 selbsthaltend  
 glatt

Mikro-Pinzetten  
Micro Forceps  
Pinzas para microscopia  
Pinze per microscopia



**GRAEFE**  
10,0 cm, 4"  
SF-1810-10



**GRAEFE**  
10,0 cm, 4"  
SF-1811-10



**GRAEFE**  
10,0 cm, 4"  
SF-1813-10



**GRAEFE**  
10,0 cm, 4"  
SF-1814-10



**GRAEFE**  
10,0 cm, 4"  
SF-1815-10



**GRAEFE**  
10,0 cm, 4"  
SF-1817-10

Uhrmacher Pinzetten, Gefäßdilatoren  
 Jeweller's Forceps, Vessel Dilators  
 Pinzas de relojería, Dilatadores vasculares  
 Pinze per orologiaio, Dilatatori vascolari



Fig. 3  
 11,5 cm, 4 1/2"  
 JF-1601-03



Fig. 4  
 11,5 cm, 4 1/2"  
 JF-1601-04



Fig. 5  
 11,5 cm, 4 1/2"  
 JF-1601-05



Fig. 7  
 11,5 cm, 4 1/2"  
 JF-1601-07

0,3 mm x 45°



9 mm

11,0 cm, 4 3/8"  
 JF-1620-01

0,3 mm x 90°



9 mm

11,0 cm, 4 3/8"  
 JF-1620-02

0,3 mm



9 mm

11,0 cm, 4 3/8"  
 JF-1620-03

0,3 mm x 45°



9 mm

11,0 cm, 4 3/8"  
 JF-1620-04

diamantbeschichtet  
 diamond coated  
 diamantado  
 diamantato



Gefäßdilatoren, Atraumatische Pinzetten  
 Vessel Dilators, Atraumatic Forceps  
 Dilatadores vasculares, Pinzas atraumáticas  
 Dilatori vascolari, Pinze anatomiche atraumatica

0,3 mm



9 mm

12,0 cm, 4<sup>3</sup>/<sub>4</sub>"  
 AF-1634-12

0,3 mm



9 mm

13,5 cm, 5<sup>3</sup>/<sub>8</sub>"  
 AF-1634-13

0,4 mm



9 mm

13,5 cm, 5<sup>3</sup>/<sub>8</sub>"  
 AF-1635-13

0,3 mm x 45°



9 mm

13,5 cm, 5<sup>3</sup>/<sub>8</sub>"  
 AF-1637-13



1,5 mm    2,0 mm    2,4 mm    2,8 mm



16,0 cm, 6<sup>1</sup>/<sub>4</sub>" AF-1700-16 AF-1702-16 AF-1704-16 AF-1706-16  
 20,0 cm, 8" AF-1700-20 AF-1702-20 AF-1704-20 AF-1706-20  
 24,0 cm, 9<sup>1</sup>/<sub>2</sub>" AF-1700-24 AF-1702-24 AF-1704-24 AF-1706-24  
 30,0 cm, 12" AF-1700-30 AF-1702-30 AF-1704-30 AF-1706-30

2,8 mm    3,5 mm    3,5 mm



16,0 cm, 6<sup>1</sup>/<sub>4</sub>" AF-1716-16 AF -1708-16 AF -1718-16  
 20,0 cm, 8" AF-1716-20 AF -1708-20 AF -1718-20  
 24,0 cm, 9<sup>1</sup>/<sub>2</sub>" AF-1716-24 AF -1708-24 AF -1718-24  
 30,0 cm, 12" AF-1716-30 AF-1708-30 AF-1718-30

DE BAKEY



1,5 mm    2,0 mm



16,0 cm, 6<sup>1</sup>/<sub>4</sub>" AF-1701-16 AF-1703-16  
 20,0 cm, 8" AF-1701-20 AF-1703-20  
 24,0 cm, 9<sup>1</sup>/<sub>2</sub>" AF-1701-24 AF-1703-24  
 30,0 cm, 12" AF-1701-30 AF-1703-30

DE BAKEY

Pinzette mit Hartmetalleinlagen  
 Forceps with tungsten carbide inserts  
 Pinzas con bocas de carburo tungsteno  
 Pinze con morsi in carburo di tungsteno



STANDARD	
14,5 cm, 5 <sup>3</sup> / <sub>4</sub> "	<b>TC-1200-14</b>
16,0 cm, 6 <sup>1</sup> / <sub>4</sub> "	<b>TC-1200-16</b>
18,0 cm, 7"	<b>TC-1200-18</b>
20,0 cm, 8"	<b>TC-1200-20</b>
25,0 cm, 10"	<b>TC-1200-25</b>
30,0 cm, 12"	<b>TC-1200-30</b>

STANDARD	
14,0 cm, 5 <sup>1</sup> / <sub>2</sub> "	<b>TC-1208-14</b>
16,0 cm, 6 <sup>1</sup> / <sub>4</sub> "	<b>TC-1208-16</b>
18,0 cm, 7"	<b>TC-1208-18</b>
20,0 cm, 8"	<b>TC-1208-20</b>
25,0 cm, 10"	<b>TC-1208-25</b>
30,0 cm, 12"	<b>TC-1208-30</b>

STANDARD	
12,5 cm, 5"	<b>TC-1040-12</b>
15,0 cm, 6"	<b>TC-1040-15</b>

STANDARD	
15,0 cm, 6"	<b>TC-1140-15</b>
23,0 cm, 9"	<b>TC-1140-23</b>
25,0 cm, 10"	<b>TC-1140-25</b>

Pinzette con Hartmetalleinlagen  
 Forceps with tungsten carbide inserts  
 Pinzas con bocas de carburo tungsteno  
 Pinze con morsi in carburo di tungsteno



**GILLIES**  
 15,0 cm, 6"  
 TC-1300-15



**MC INDOE**  
 15,0 cm, 6"  
 TC-1158-15



**GERALD**  
 17,0 cm, 6<sup>3</sup>/<sub>4</sub>"



**POTTS-SMITH**  
 15,0 cm, 6" **TC-1026-15**  
 18,0 cm, 7" **TC-1026-18**  
 20,0 cm, 8" **TC-1026-20**



**BONNEY**  
 17,5 cm, 6<sup>5</sup>/<sub>8</sub>"  
 TC-1590-17



**CUSHING**  
 17,5 cm, 6<sup>5</sup>/<sub>8</sub>"



**CUSHING-TAYLOR**  
 18,0 cm, 7"  
 TC-1117-18



**ADSON**  
 17,5 cm, 6<sup>5</sup>/<sub>8</sub>"

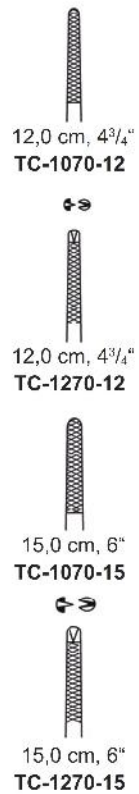



**Tuch-, Schlauchklemmen, Tupferzangen**

**Towel Clamps, Sponge and Dressing Forceps, Tubing Clamps**

**Pinzas de campo, Pinzas para vendajes y torundas y para tubos**

**Pinze per fissare le compresse, per medicatura e tamponi, e per tubi**



Tuchklemmen  
Towel Clamps  
Pinzas de campo  
Pinze per fissare le compresse



**SCHAEDEL**  
9,0 cm, 3 1/2"  
HF-1101-09



**ENGL. MODELL**  
9,0 cm, 3 1/2"  
HF-1109-09



**JONES**  
5,0 cm, 2" **HF-1105-05**  
7,0 cm, 2 3/4" **HF-1105-07**  
9,0 cm, 3 1/2" **HF-1105-09**



**JONES**  
9,0 cm, 3 1/2"  
HF-1107-09

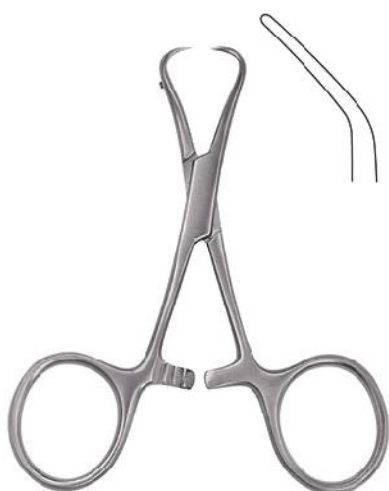

**BACKHAUS**  
9,0 cm, 3 1/2" **HF-1000-09**  
11,0 cm, 4 3/8" **HF-1000-11**  
13,0 cm, 5" **HF-1000-13**  
15,0 cm, 6" **HF-1000-15**



mit Schlauch- oder Kabelhalter  
with clip for tubing or cable  
con porta-tubo o porta-cavo  
con porta-tubo o porta-cavo

11,0 cm, 4 3/8"  
**HF-1005-11**



**ROEDER**  
13,0 cm, 5"  
HF-1010-13

Tuchklemmen  
Towel Clamps  
Pinzas de campo  
Pinze per fissare le compresse



**ROEDER**  
15,0 cm, 5"  
HF-1010-15



**BERNHARD**  
16,5 cm, 6 1/2"  
HF-1044-16

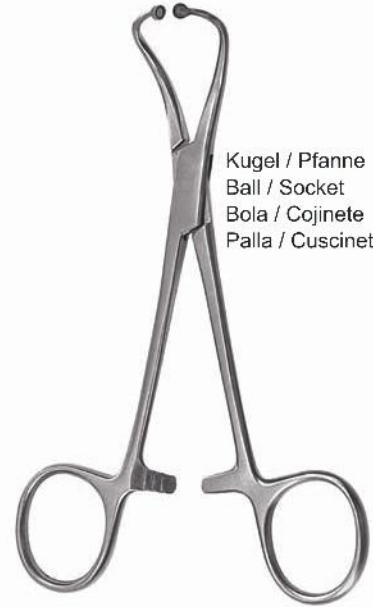

Kugel / Pfanne  
Ball / Socket  
Bola / Cojinete  
Palla / Cuscinetto

13,0 cm, 5"  
HF-1024-13

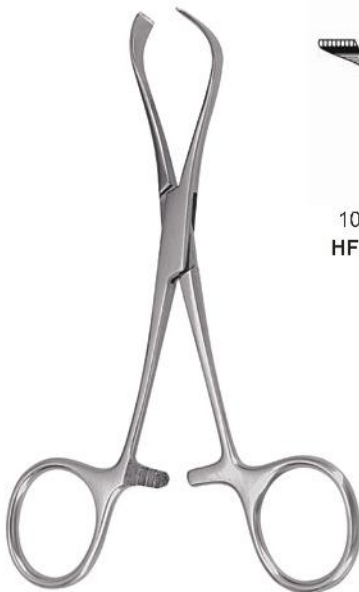

**LORNA**



10,0 cm, 4" HF-1014-10  
13,0 cm, 5" HF-1014-13



**LANE**  
15,0 cm, 6" HF-1040-15  
18,0 cm, 7" HF-1040-18  
20,0 cm, 8" HF-1040-20

Tuchklemmen, Korn- und Tupferzangen  
 Towel Clamps, Sponge and Dressing Forceps  
 Pinzas de campo, Pinzas para vendajes y torundas  
 Pinze per fissare le compresse, Pinze per medicatura e tamponi



**TOHOKU**

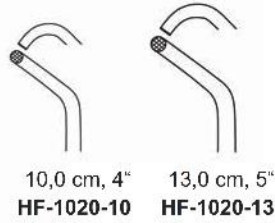

**PEERS**  
 14,5  
 HF-



**LISTER**  
 13,0 cm, 5" HF-1360-13  
 16,0 cm, 6 1/4" HF-1360-16  
 18,0 cm, 7" HF-1360-18



**BRYANT**  
 13,0 cm, 5"  
 HF-1351-13

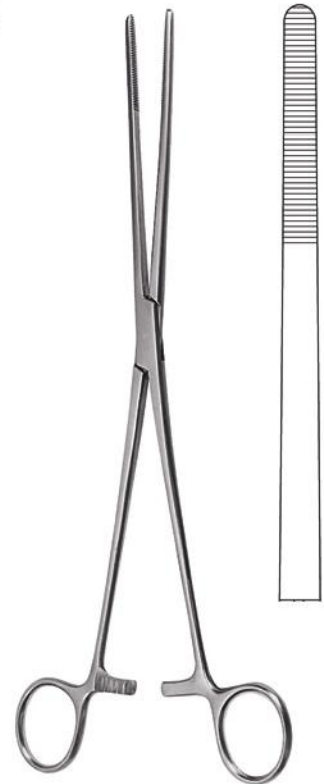

**BOZEMANN**  
 26,0 cm, 10 1/4"  
 HF-1320-26

Korn- und Tupferzangen  
Sponge and Dressing Forceps  
Pinzas para vendajes y torundas  
Pinze per medicatura e tamponi

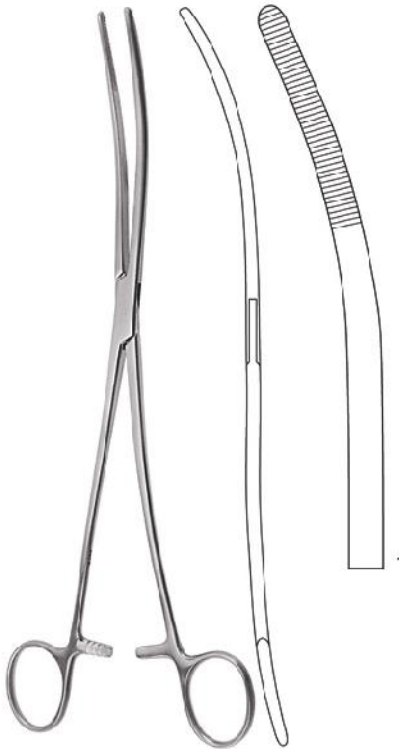

**BOZEMANN**  
26,0 cm, 10<sup>1</sup>/<sub>4</sub>"  
HF-1321-26



**COLLIN**  
25,0 cm, 9<sup>3</sup>/<sub>4</sub>"  
HF-1300-25



**CHERON**  
25,0 cm, 9<sup>3</sup>/<sub>4</sub>"  
HF-1303-25



**PERLKMANN**  
25,0 cm, 9<sup>3</sup>/<sub>4</sub>"

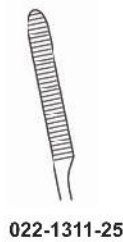

022-1311-25



**ULRICH**

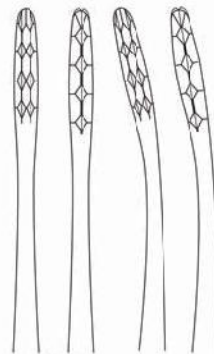

22,0 cm, 8<sup>5</sup>/<sub>8</sub>" HF-1200-22 HF-1201-22  
25,0 cm, 9<sup>3</sup>/<sub>4</sub>" HF-1200-22 HF-1201-25  
27,0 cm, 10<sup>5</sup>/<sub>8</sub>" HF-1200-22 HF-1201-27



Korn- und Tupferzangen  
Sponge and Dressing Forceps  
Pinzas para vendajes y torundas  
Pinze per medicatura e tamponi



**GROSS-MAIER**

20,0 cm, 8"	HF-1210-20	HF-1211-20
22,0 cm, 8 <sup>5</sup> / <sub>8</sub> "	HF-1210-22	HF-1211-22
25,0 cm, 9 <sup>3</sup> / <sub>4</sub> "	HF-1210-25	HF-1211-25
27,0 cm, 10 <sup>5</sup> / <sub>8</sub> "	HF-1210-27	HF-1211-27

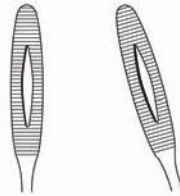

**FOERSTER**

25,0 cm, 9 <sup>3</sup> / <sub>4</sub> "	HF-1180-25
25,0 cm, 9 <sup>3</sup> / <sub>4</sub> "	HF-1181-25



**FOERSTER-BALLEGER**

18,0 cm, 7"	HF -1160-18	HF -1161-18	HF-1170-18	HF-1171-18
20,0 cm, 8"	HF-1160-20	HF -1161-20	HF-1170-20	HF -1171-20
25,0 cm, 9 <sup>3</sup> / <sub>4</sub> "	HF-1160-25	HF-1161-25	HF-1170-25	HF-1171-25

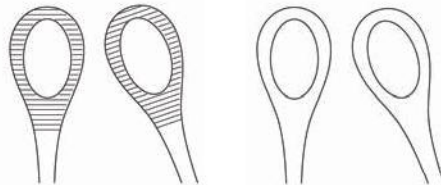

<b>RAMPLEY</b>	
18,0 cm, 7"	HF-1190-18
25,0 cm, 9 <sup>3</sup> / <sub>4</sub> "	HF-1190-25

Schlauchklemmen  
Tubing Clamps  
Pinzas para tubos  
Pinze per tubi



**PRESBYTERIAN**



16,5 cm, 6 $\frac{1}{2}$ "	HF-1012-16
18,0 cm, 7"	HF-1012-18
20,0 cm, 8"	HF-1012-20





**BERLIN**

14,5 cm, 5 $\frac{3}{4}$ "  
HF-1006-14



		
15,0 cm, 6"	18,0 cm, 7"	20,0 cm, 8"
HF-1002-15	HF-1002-18	HF-1002-20



		
15,0 cm, 6"	18,0 cm, 7"	20,0 cm, 8"
HF-1004-15	HF-1004-18	HF-1004-20

MIT BÜGEL



**Klemmen**

**Forceps**

**Pinas**

**Pinze**



Bulldogklemmen  
Bulldog Clamps  
Clamps Bulldog  
Pinze Bulldog

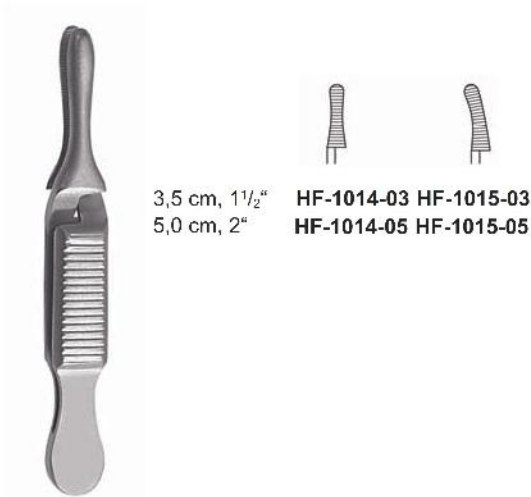

3,5 cm, 1 1/2"  
5,0 cm, 2"  
HF-1014-03 HF-1015-03  
HF-1014-05 HF-1015-05

**DIEFFENBACH**



**HESS**  
HF-1520-01



**HESS**  
HF-1520-02

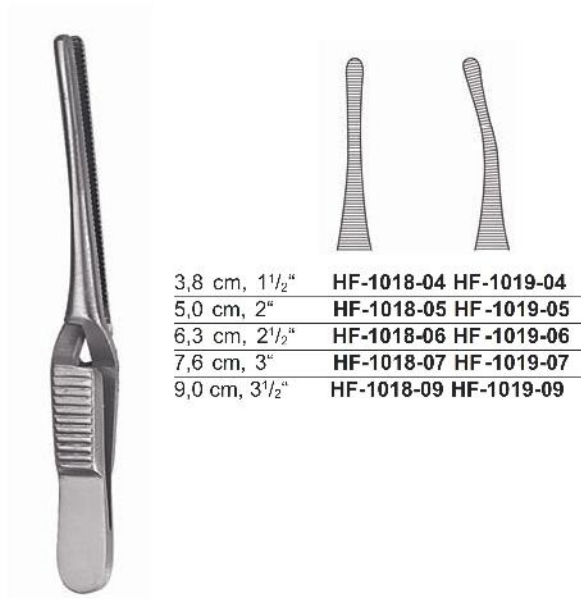

3,8 cm, 1 1/2"  
5,0 cm, 2"  
6,3 cm, 2 1/2"  
7,6 cm, 3"  
9,0 cm, 3 1/2"  
HF-1018-04 HF-1019-04  
HF-1018-05 HF-1019-05  
HF-1018-06 HF-1019-06  
HF-1018-07 HF-1019-07  
HF-1018-09 HF-1019-09

**JOHNS-HOPKINS**



**JOHNS-HOPKINS**  
23,0 cm, 9"  
HF-1295-23



mit atraumatischer Riefung  
with non-traumatic serration  
con bocas atraumáticas  
con presa atraumatica

		L
7,5 cm, 3"	<b>HF-1292-07</b>	2,5 cm, 1"
8,5 cm, 3 1/4"	<b>HF-1292-08</b>	3,5 cm, 1 3/8"
10,5 cm, 4 1/8"	<b>HF-1292-10</b>	5,0 cm, 2"
12,0 cm, 4 3/4"	<b>HF-1292-12</b>	6,8 cm, 2 3/4"

DE BAKEY



mit atraumatischer Riefung  
with non-traumatic serration  
con bocas atraumáticas  
con presa atraumatica

		L
7,0 cm, 2 3/4"	<b>HF-1293-07</b>	2,5 cm, 1"
8,0 cm, 3 1/8"	<b>HF-1293-08</b>	3,5 cm, 1 3/8"
10,0 cm, 3 3/4"	<b>HF-1293-10</b>	5,0 cm, 2"
11,5 cm, 4 1/2"	<b>HF-1293-12</b>	6,8 cm, 2 3/4"

DE BAKEY



**TITANIUM**  
3,5 cm, 1 3/8"  
vena **HF-1032-35**  
arteria **HF-1042-35**



**TITANIUM**  
3,5 cm, 1 3/8"  
vena **HF-1033-35**  
arteria **HF-1043-35**



**TITANIUM**  
4,0 cm, 1 5/8"  
vena **HF-1032-40**  
arteria **HF-1042-40**



**TITANIUM**  
4,0 cm, 1 5/8"  
vena **HF-1033-40**  
arteria **HF-1043-40**

Bulldogklemmen, Darm- und Gewebefaßzangen  
 Bulldog Clamps, Intestinal and Tissue Grasping Forceps  
 Clamps Bulldog, Pinzas intestinales y para tejidos  
 Pinze Bulldog, Pinze da presa per intestino e tessuti

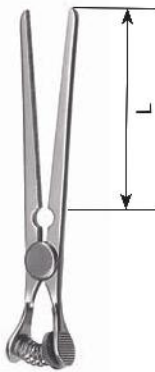

6,8 cm, 2 <sup>3</sup> / <sub>4</sub> "	HF-1298-07	3,3 cm, 1 <sup>3</sup> / <sub>8</sub> "
9,6 cm, 3 <sup>3</sup> / <sub>4</sub> "	HF-1298-09	5,0 cm, 2"
11,7 cm, 4 <sup>3</sup> / <sub>4</sub> "	HF-1298-11	6,9 cm, 2 <sup>3</sup> / <sub>4</sub> "

GLOVER

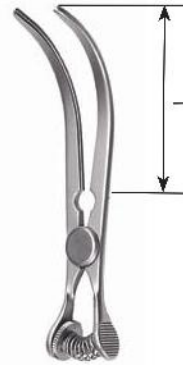

6,5 cm, 2 <sup>1</sup> / <sub>2</sub> "	HF-1299-06	3,3 cm, 1 <sup>3</sup> / <sub>8</sub> "
9,1 cm, 3 <sup>1</sup> / <sub>2</sub> "	HF-1299-09	5,0 cm, 2"
11,0 cm, 4 <sup>3</sup> / <sub>8</sub> "	HF-1299-11	6,9 cm, 2 <sup>3</sup> / <sub>4</sub> "

GLOVER



**CHAPUT**  
 13,0 cm, 5"  
 HF-1370-13



**TUFFIER**  
 13,0 cm, 5"  
 HF-1372-13



**COLLIN**  
 16,0 cm, 6<sup>1</sup>/<sub>4</sub>"  
 HF-1376-16

Darm- und Gewebefaszangen  
Intestinal and Tissue Grasping Forceps  
Pinzas intestinales y para tejidos  
Pinze da presa per intestino e tessuti



**PENNINGTON**

15,5 cm, 6" HF-1358-15  
20,0 cm, 8" HF-1358-20



**ATRAUMA**

25,0 cm, 9<sup>3</sup>/<sub>4</sub>"  
HF-1658-25



27,0 cm, 10<sup>1</sup>/<sub>2</sub>"  
HF-1658-27



**MARTEL**  
14,0 cm, 5<sup>1</sup>/<sub>2</sub>"  
HF-1364-14

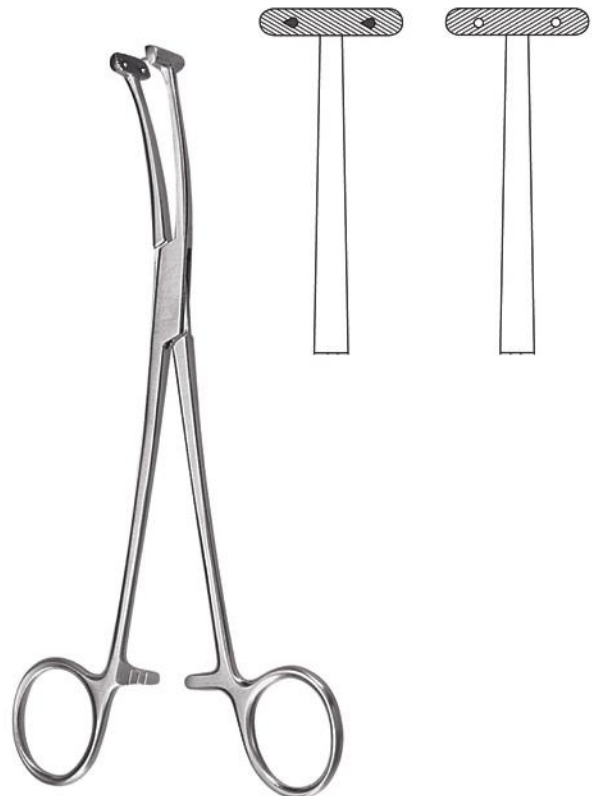

**WILLET-MARTEL**  
19,0 cm, 7<sup>1</sup>/<sub>2</sub>"  
HF-1366-19

Arterienklemmen  
Haemostatic Forceps  
Pinzas hemostáticas  
Pinzas



**PRATT**  
15,0 cm, 6"  
HF-1656-15



**FERGUSSON**

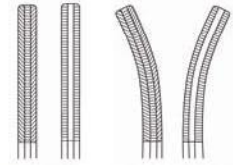

16,0 cm, 6 $\frac{1}{4}$ " **HF-650-16** **HF-651-16**  
20,0 cm, 8" **HF-650-20** **HF-651-20**



**CARREL**  
10,0 cm, 4"  
HF-1010-10



**TERRIER**  
10,0 cm, 4"  
HF-1016-10



**KROENLEIN**  
13,0 cm, 5"  
HF-1369-13



Arterienklemmen  
Haemostatic Forceps  
Pinzas hemostáticas  
Pinze emostatiche



**PEAN**

14,0 cm, 5 1/2"	<b>HF-1368-14</b>
16,0 cm, 6 1/4"	<b>HF-1368-16</b>

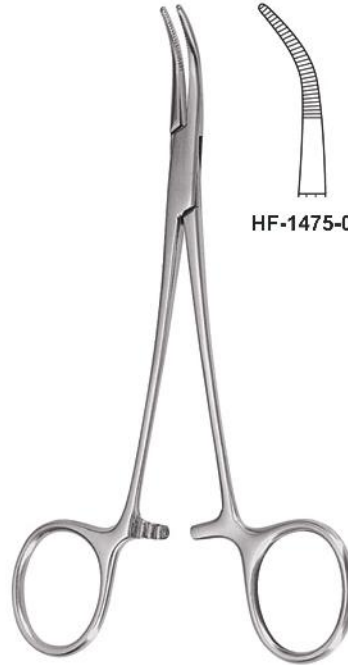

**BABY-MIXTER**

14,0 cm, 5 1/2"

HF-1475-01

HF-1475-02



**SPENCER-WELLS**

13,0 cm, 5"	<b>HF-1290-13 HF -1291-13</b>
15,0 cm, 6"	<b>HF-1290-15 HF -1291-15</b>
18,0 cm, 7"	<b>HF-1290-18 HF -1291-18</b>
20,0 cm, 8"	<b>HF-1290-20 HF-1291-20</b>



**HARTMANN**

10,0 cm, 4"

HF-1000-10

HF-1001-10

Arterienklemmen  
Haemostatic Forceps  
Pinzas hemostáticas  
Pinze emostatiche

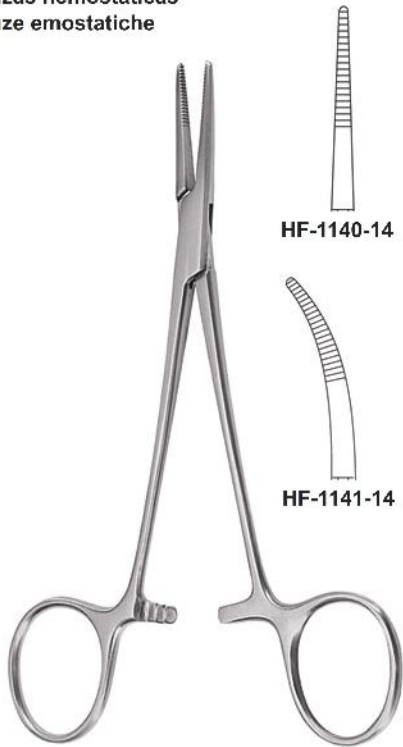

**PROVINCENCE-HOSPITAL**  
14,0 cm, 5 1/2"

HF-1140-14

HF-1141-14

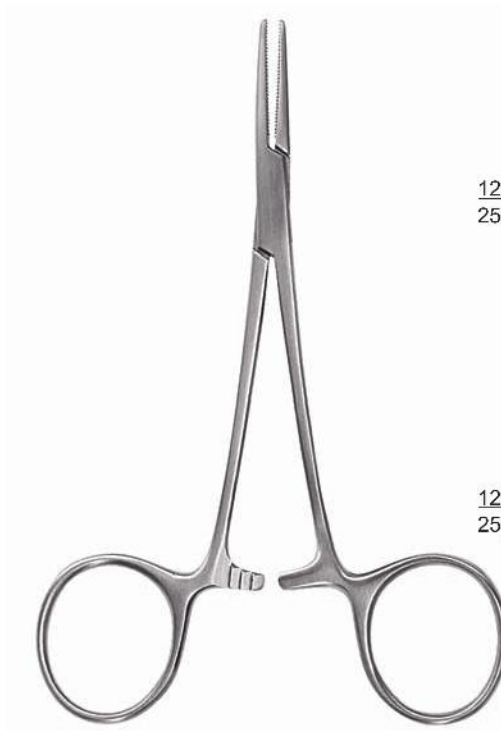

**HALSTED-MOSQUITO**

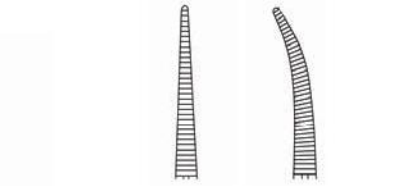

12,5 cm, 5" HF-1050-12 HF-1051-12  
25,0 cm, 9 3/4" HF-1050-14 HF-1051-14

1 x 2      1 x 2



12,5 cm, 5" HF-1070-12 HF-1071-12  
25,0 cm, 9 3/4" HF-1070-14 HF-1071-14



**HALSTED-MOSQUITO**

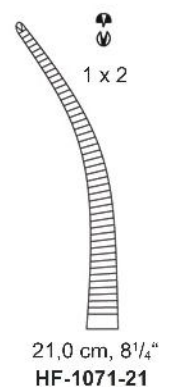
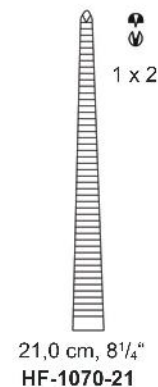
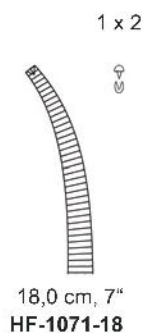
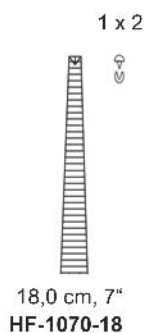
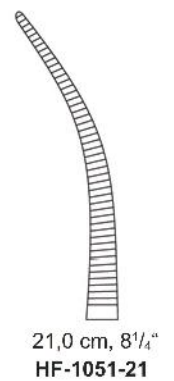
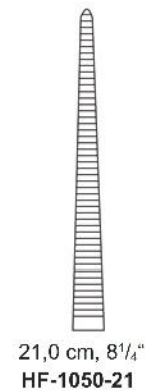
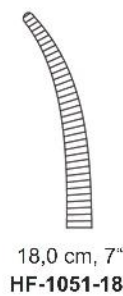
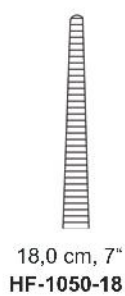

Arterienklemmen  
Haemostatic Forceps  
Pinzas hemostáticas  
Pinze emostatiche



**MICRO-MOSQUITO**

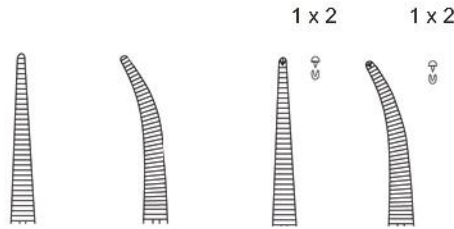

10,0 cm, 4" HF-1020-10 HF-1021-10 HF-1030-10 HF-1031-10  
12,0 cm, 4<sup>3</sup>/<sub>4</sub>" HF-1020-12 HF-1021-12 HF-1030-12 HF-1031-12

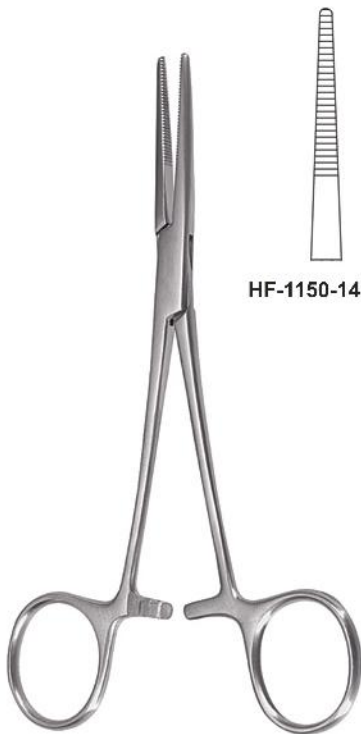

**KELLY**  
14,0 cm, 5<sup>1</sup>/<sub>2</sub>"

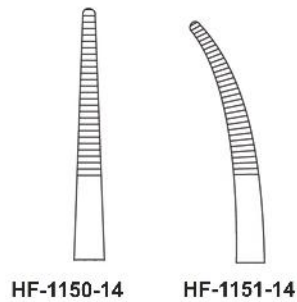

**KELLY-RANKIN**  
16,0 cm, 6<sup>1</sup>/<sub>4</sub>"

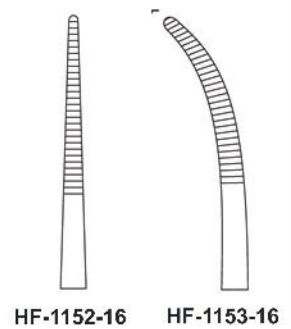

Arterienklemmen  
Haemostatic Forceps  
Pinzas hemostáticas  
Pinze emostatiche



**LERICHE**  
15,0 cm, 6"



HF-1380-15



HF-1381-15

1 x 2

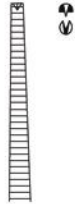

HF-1382-15

1 x 2



HF-1383-15



**BABY-OVERHOLT**  
13,5 cm, 5 1/4"  
HF-1424-14



**DANDY**  
14,0 cm, 5 1/2"

1 x 2

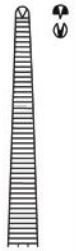

HF-1347-14



**CRILE**  
14,0 cm, 5 1/2"



HF-1160-14



HF-1161-14

1 x 2

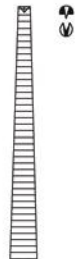

HF-1170-14

1 x 2



HF-1171-14

Arterienklemmen  
Haemostatic Forceps  
Pinzas hemostáticas  
Pinze emostatiche



**DIXON-LOVELACE**  
15,0 cm, 6"

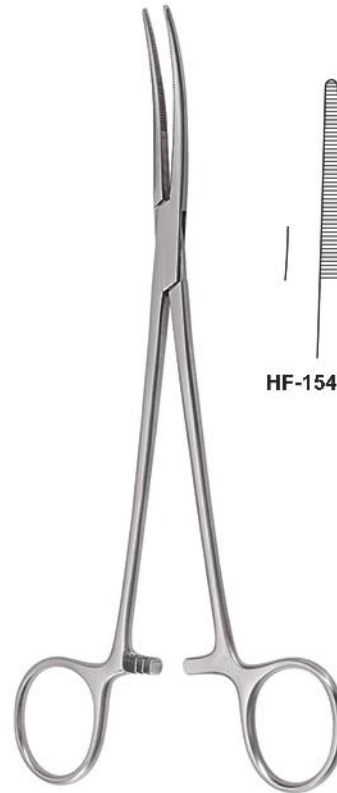
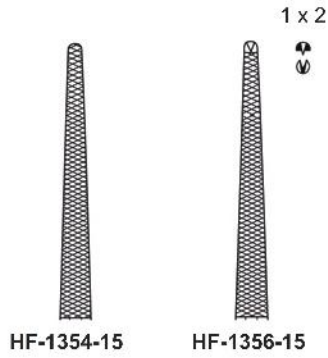

**BIRKETT**  
19,0 cm, 7½"

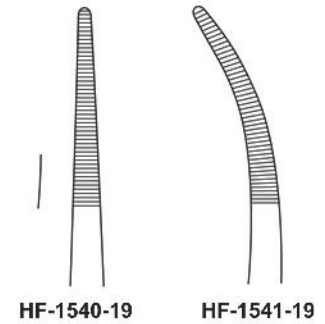

**CRILE-RANKIN**  
16,0 cm, 6½"

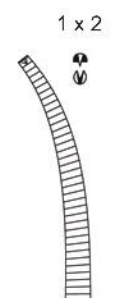
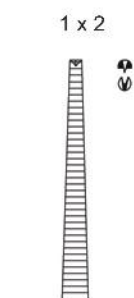
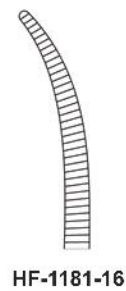

Arterienklemmen  
Haemostatic Forceps  
Pinzas hemostáticas  
Pinze emostatiche



HF-187-19

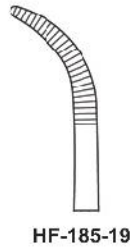

HF-185-19

**SCHNIDT**  
19,0 cm, 7 1/2"



HF-183-19

HF-181-19

**SCHNIDT-SAWTELL**  
19,0 cm, 7 1/2"



**ADSON**  
18,5 cm, 7 1/4"

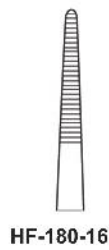

HF-180-16

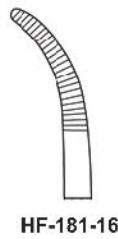

HF-181-16

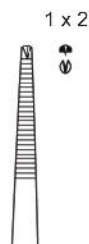

HF-182-16



HF-183-16

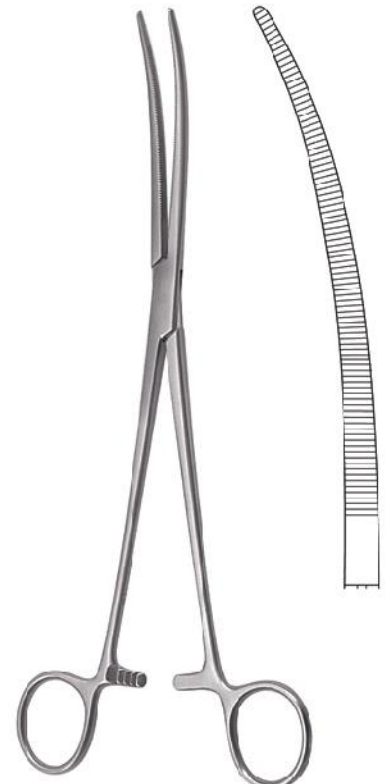

**CRAFOORD**  
24,0 cm, 9 1/2"  
HF-453-24

Arterienklemmen  
Haemostatic Forceps  
Pinzas hemostáticas  
Pinze emostatiche



15,0 cm, 6" HF-1480-15 HF-1481-15  
18,5 cm, 7 1/4" HF-1480-18 HF-1481-18

**BAINBRIDGE**



16,0 cm, 6 1/4" HF-1340-16 HF-1341-16  
20,0 cm, 8" HF-1340-20 HF-1341-20

**ROCHESTER-CARMALT**



13,0 cm, 5" HF-1262-13 HF-1263-13  
14,0 cm, 5 1/2" HF-1262-14 HF-1263-14  
16,0 cm, 6 1/4" HF-1262-16 HF-1263-16

**PEAN DELICATE**



13,0 cm, 5" HF-1352-13 HF-1353-13  
14,0 cm, 5 1/2" HF-1352-14 HF-1353-14  
16,0 cm, 6 1/4" HF-1352-16 HF-1353-16

**KOCHER DELICATE**

Arterienklemmen  
Haemostatic Forceps  
Pinzas hemostáticas  
Pinze emostatiche



ROCHESTER-PEAN

14,0 cm, 5½"	HF-1260-14	HF -1261-14
16,0 cm, 6¼"	HF-1260-16	HF -1261-16
18,0 cm, 7"	HF-1260-18	HF -1261-18
20,0 cm, 8"	HF-1260-20	HF -1261-20
22,0 cm, 8⅝"	HF-1260-22	HF -1261-22
24,0 cm, 9½"	HF-1260-24	HF -1261-24
26,0 cm, 10¼"	HF-1260-26	HF -1261-26
30,0 cm, 12"	HF-1260-30	HF-1261-30

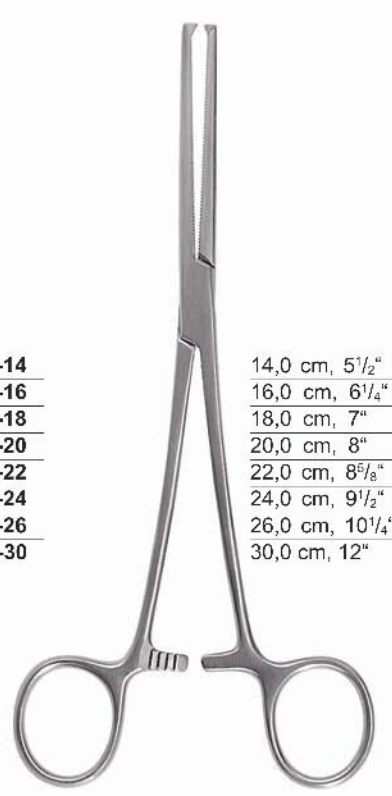
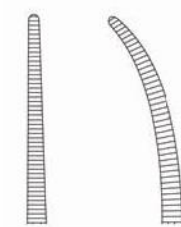

KOCHER-OCHSNER

14,0 cm, 5½"	HF-1350-14	HF -1351-14
16,0 cm, 6¼"	HF-1350-16	HF -1351-16
18,0 cm, 7"	HF-1350-18	HF -1351-18
20,0 cm, 8"	HF-1350-20	HF -1351-20
22,0 cm, 8⅝"	HF-1350-22	HF -1351-22
24,0 cm, 9½"	HF-1350-24	HF -1351-24
26,0 cm, 10¼"	HF-1350-26	HF -1351-26
30,0 cm, 12"	HF-1350-30	HF-1351-30

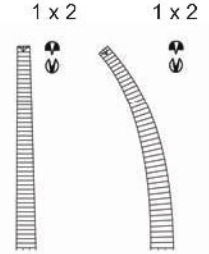

BENGOLEA

20,0 cm, 8"	HF-1384-20	HF-1385-20	HF-1386-20	HF-1387-20
26,0 cm, 10¼"	HF-1384-26	HF-1385-26	HF-1386-26	HF-1387-26

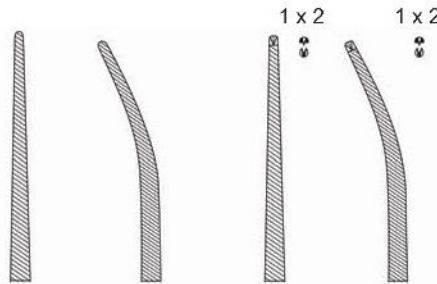



Arterienklemmen  
Haemostatic Forceps  
Pinzas hemostáticas  
Pinze emostatiche



HF-1390-20 HF-1391-20 HF-1393-20

**HEISS**  
20,0 cm, 8"

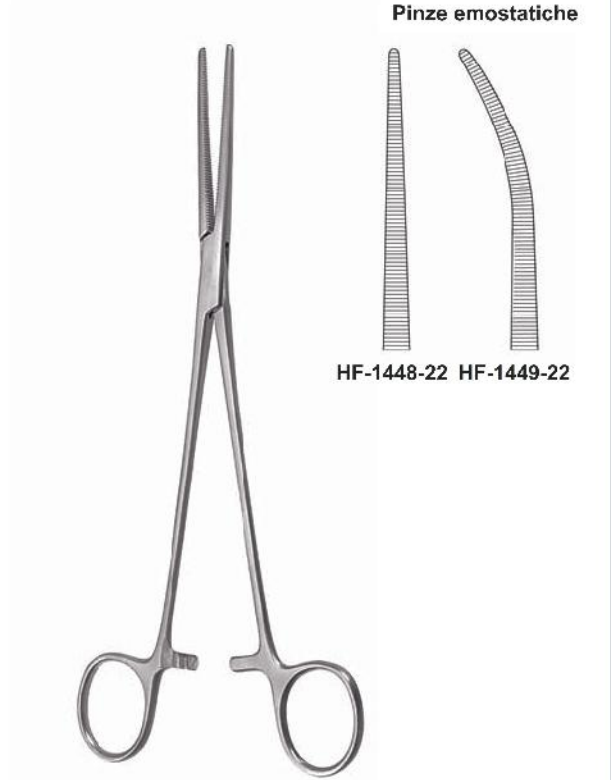

HF-1448-22 HF-1449-22

**ROBERTS**  
22,0 cm, 8<sup>5</sup>/<sub>8</sub>"

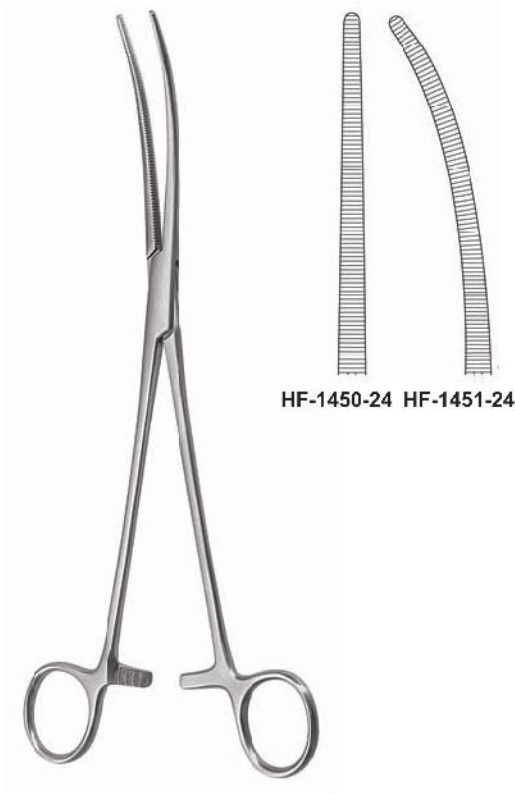

HF-1450-24 HF-1451-24

**SAROT**  
24,0 cm, 9<sup>1</sup>/<sub>2</sub>"



HF-1533-01 HF-1533-02

**NEGUS**  
19,0 cm, 7<sup>1</sup>/<sub>2</sub>"

Präparier- und Ligaturklemmen  
Dissecting and Ligature Forceps  
Pinzas de disección y ligaduras  
Pinze per preparazioni e legature



14,0 cm, 5½"  
HF-1411-14

18,0 cm, 7"  
HF-1411-18



**MICRO-ADSON**  
14,0 cm, 5½"  
HF-1409-14



**BABY-MIXTER**  
18,0 cm, 7"  
HF-1475-18



**OVERHOLT-MIXTER**  
21,0 cm, 8¼"  
HF-1471-21



**JOHNS HOPKINS**  
20,0 cm, 8"  
HF-1497-20

Präparier- und Ligaturklemmen  
Dissecting and Ligature Forceps  
Pinzas de disección y ligaduras  
Pinze per preparazioni e legature



**OVERHOLT**

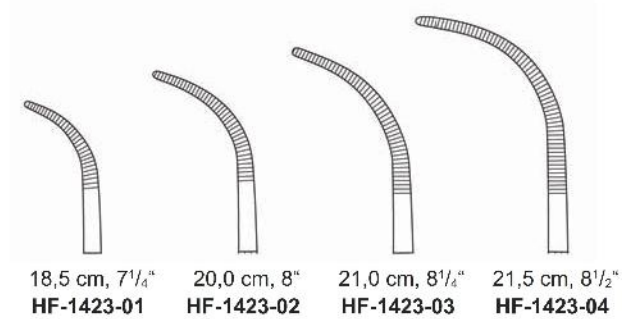

**RUMEL**  
23,0 cm, 9"

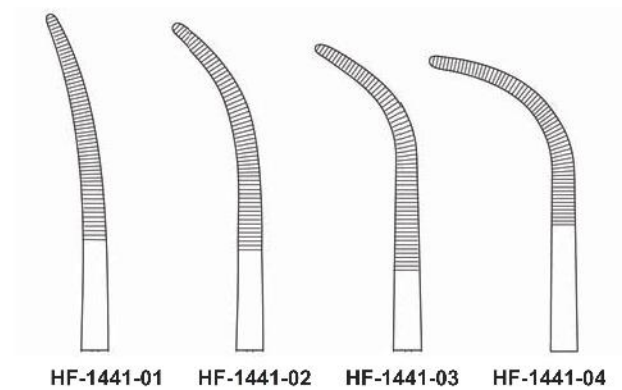

Präparier- und Ligaturklemmen  
 Dissecting and Ligature Forceps  
 Pinzas de disección y ligaduras  
 Pinze per preparazioni e legature



OVERHOLT-GEISSENDOERFER

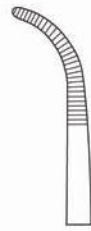

**HF-1421-01**  
 19,5 cm, 7<sup>3</sup>/<sub>4</sub>"



**HF-1421-02**  
 19,0 cm, 7<sup>1</sup>/<sub>2</sub>"

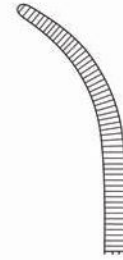

**HF-1421-03**  
 21,0 cm, 8<sup>1</sup>/<sub>4</sub>"

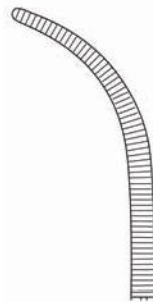

**HF-1421-04**  
 22,0 cm, 8<sup>3</sup>/<sub>4</sub>"

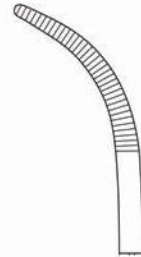

**HF-1421-05**  
 21,5 cm, 8<sup>1</sup>/<sub>2</sub>"

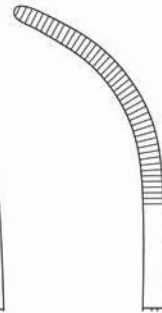

**HF-1421-06**  
 22,0 cm, 8<sup>3</sup>/<sub>4</sub>"



**HF-1421-07**  
 22,0 cm, 8<sup>3</sup>/<sub>4</sub>"



OVERHOLT-GEISSENDOERFER

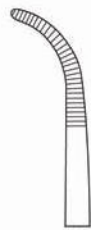

**HF-1422-01**  
 27,0 cm, 10<sup>3</sup>/<sub>4</sub>"

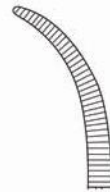

**HF-1422-02**  
 26,0 cm, 10<sup>1</sup>/<sub>2</sub>"



**HF-1422-03**  
 27,0 cm, 10<sup>3</sup>/<sub>4</sub>"

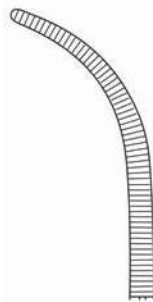

**HF-1422-04**  
 27,5 cm, 10<sup>3</sup>/<sub>4</sub>"

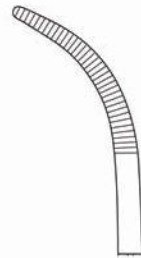

**HF-1422-05**  
 27,5 cm, 10<sup>3</sup>/<sub>4</sub>"

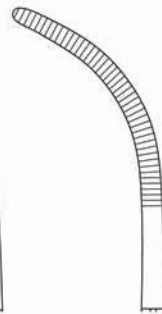

**HF-1422-06**  
 28,0 cm, 11"



**HF-1422-07**  
 28,0 cm, 11"

Präparier- und Ligaturklemmen  
 Dissecting and Ligature Forceps  
 Pinzas de disección y ligaduras  
 Pinze per preparazioni e legature

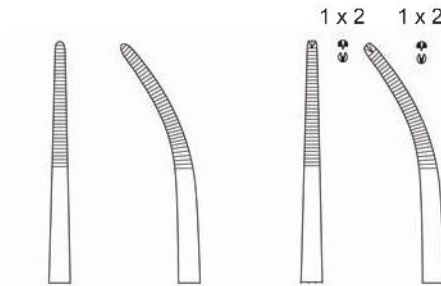

21,0 cm, 8 1/2" HF-1442-21 HF-1443-21 HF-1444-21 HF-1445-21  
 26,0 cm, 10 1/4" HF-1442-26 HF-1443-26 HF-1444-26 HF-1445-26

TOENNIS

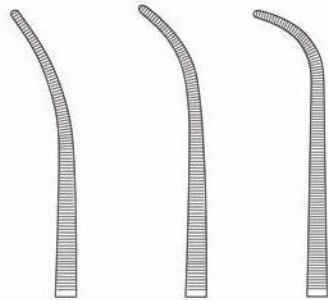

19,0 cm, 7 1/2" HF-1463-19 HF -1465-19 HF-1467-19  
 22,0 cm, 8 5/8" HF-1463-22 HF -1465-22 HF-1467-22  
 24,0 cm, 9 1/2" HF-1463-24 HF-1465-24 HF-1467-24

KELLY

Präparier- und Ligaturklemmen  
Dissecting and Ligature Forceps  
Pinzas de disección y ligaduras  
Pinze per preparazioni e legature

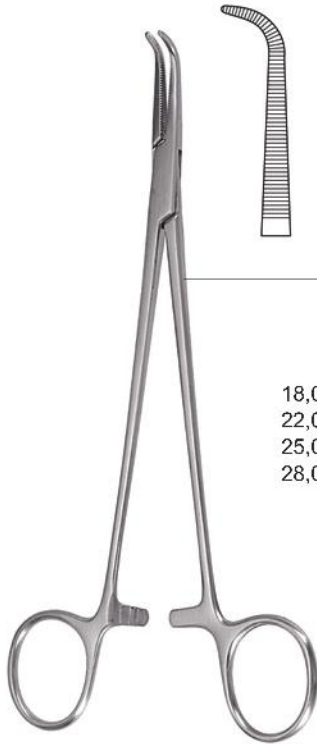

18,0 cm, 7" HF-1429-18  
22,0 cm, 8<sup>5</sup>/<sub>8</sub>" HF-1429-22  
25,0 cm, 9<sup>3</sup>/<sub>4</sub>" HF-1429-25  
28,0 cm, 11" HF-1429-28

**MINI-GEMINI**

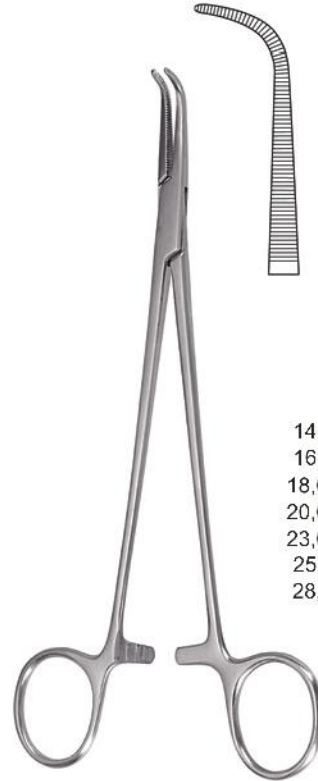

14,0 cm, 5<sup>1</sup>/<sub>2</sub>" HF-1431-14  
16,0 cm, 6<sup>1</sup>/<sub>4</sub>" HF-1431-16  
18,0 cm, 7" HF-1431-18  
20,0 cm, 8" HF-1431-20  
23,0 cm, 9" HF-1431-23  
25,0 cm, 9<sup>3</sup>/<sub>4</sub>" HF-1431-25  
28,0 cm, 11" HF-1431-28

**GEMINI**



20,0 cm, 8" HF-1433-20  
24,0 cm, 9<sup>1</sup>/<sub>2</sub>" HF-1433-24  
28,0 cm, 11" HF-1433-28

**KANTROWITZ**



19,0 cm, 7<sup>1</sup>/<sub>2</sub>" HF-1543-19  
21,0 cm, 8<sup>1</sup>/<sub>4</sub>" HF-1543-21  
24,0 cm, 9<sup>1</sup>/<sub>2</sub>" HF-1543-24

**WIKSTROEM**

Präparier- und Ligaturklemmen  
Dissecting and Ligature Forceps  
Pinzas de disección y ligaduras  
Pinze per preparazioni e legature



**MIXTER**  
15,5 cm, 6" HF-1461-15  
19,0 cm, 7 1/2" HF-1461-19



**MIXTER-O'SHAUGNESSY**  
15,5 cm, 6" HF-1477-15  
19,0 cm, 7 1/2" HF-1477-19



**MIXTER**  
22,0 cm, 8 3/4"  
HF-1473-22



**MIXTER**  
23,0 cm, 9"  
HF-1473-23

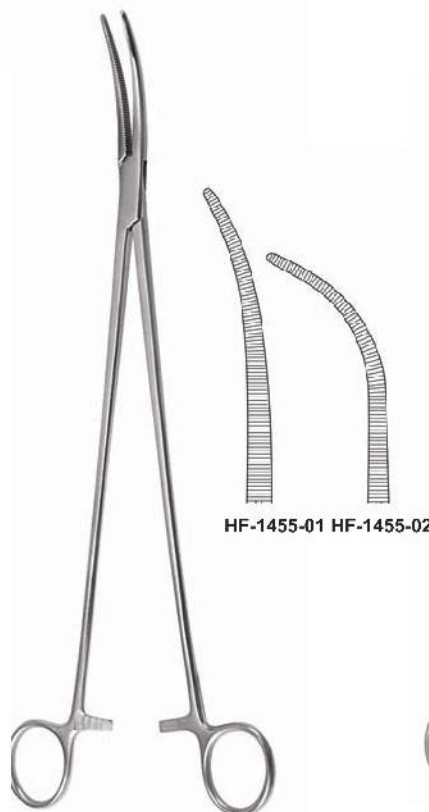

**ZENKER**

HF-1455-01 HF-1455-02



**ZENKER**

HF1459-18 HF-1459-28

Präparier- und Ligaturklemmen  
 Dissecting and Ligature Forceps  
 Pinzas de disección y ligaduras  
 Pinze per preparazioni e legature



**LAWRENCE**  
 27,5 cm, 10<sup>3</sup>/<sub>4</sub>"  
 HF-1457-28



**HOSEMANN**  
 21,0 cm, 8<sup>1</sup>/<sub>2</sub>"

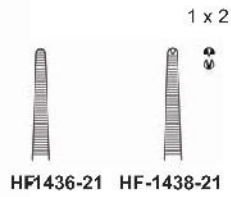

**DESJARDINS**  
 21,0 cm, 8<sup>1</sup>/<sub>4</sub>"  
 HF-1529-21

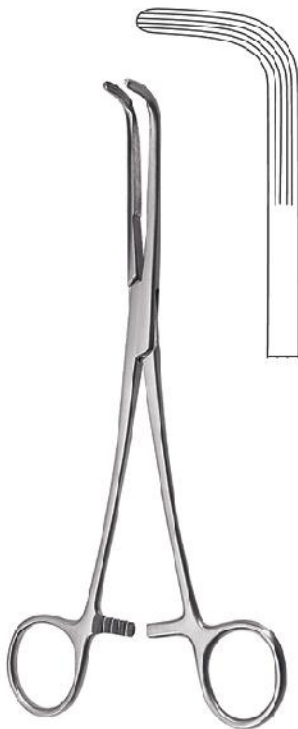

**MIXTER**  
 22,0 cm, 8<sup>3</sup>/<sub>4</sub>" HF-1479-22  
 25,0 cm, 9<sup>3</sup>/<sub>4</sub>" HF-1479-25  
 28,0 cm, 11" HF-1479-28



**LAHEY**  
 19,0 cm, 7<sup>1</sup>/<sub>2</sub>" HF-1501-19  
 23,0 cm, 9" HF-1501-23



**LOWER**  
 18,0 cm, 7"  
 HF-1503-18



Präparier- und Ligaturklemmen  
Dissecting and Ligature Forceps  
Pinzas de disección y ligaduras  
Pinze per preparazioni e legature



**MC QUIGG-MIXTER**  
22,0 cm, 8<sup>3</sup>/<sub>4</sub>"  
HF-1507-22

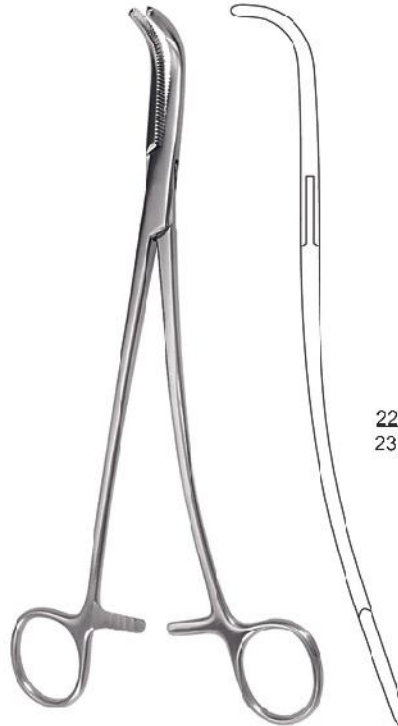

**GRAY**

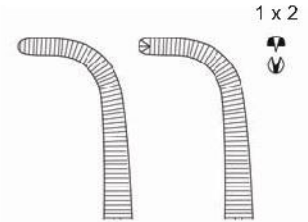

22,0 cm, 8<sup>3</sup>/<sub>4</sub>" HF-1523-22 HF-1525-22  
23,0 cm, 9" HF-1523-23 HF-1525-23



**CRAFOORD-SELLORS**

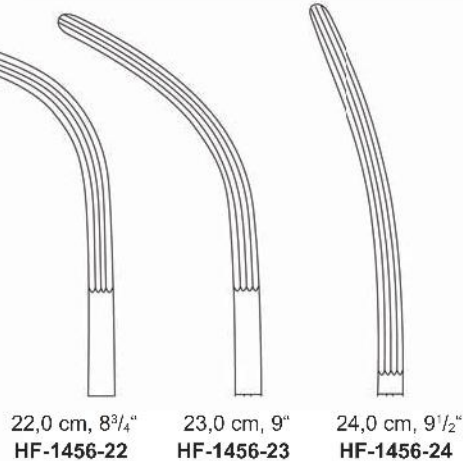

22,0 cm, 8<sup>3</sup>/<sub>4</sub>"  
HF-1456-22

23,0 cm, 9"  
HF-1456-23

24,0 cm, 9<sup>1</sup>/<sub>2</sub>"  
HF-1456-24



**FINOCCHIETTO**  
24,0 cm, 9<sup>1</sup>/<sub>2</sub>"  
HF-1505-24

Gallenkanal- und Nierenstielklemmen  
Gall Duct and Kidney Pedicle Clamps  
Pinzas-clamps para pedúnculo renal  
Pinze per peduncoli renali



**GUYON**

20,0 cm, 8"	HF-1509-20
22,0 cm, 8 <sup>3</sup> / <sub>4</sub> "	HF-1509-22
24,0 cm, 9 <sup>1</sup> / <sub>2</sub> "	HF-1509-24

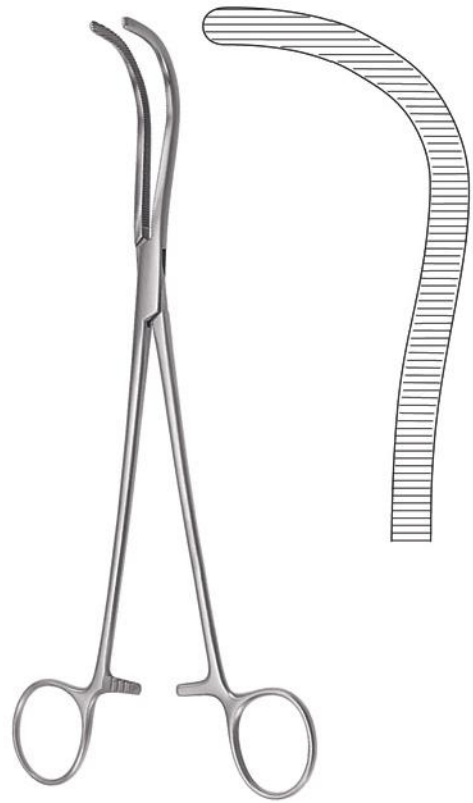

**GUYON**

23,0 cm, 9"  
HF-1513-23

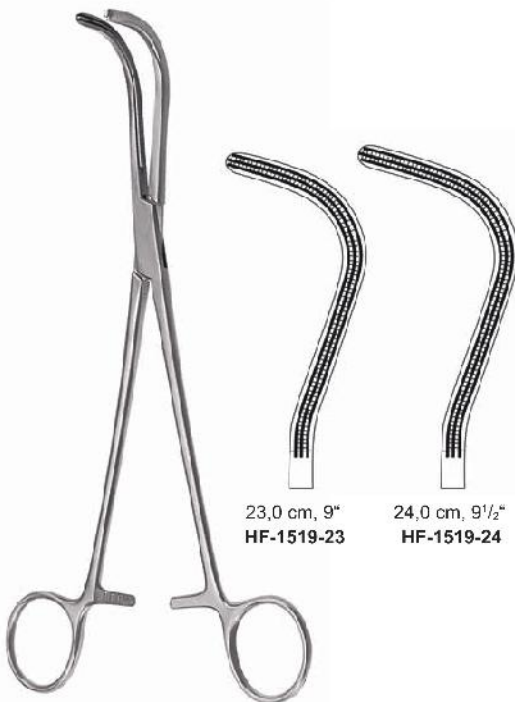

**GUYON**

23,0 cm, 9"  
HF-1519-23

24,0 cm, 9<sup>1</sup>/<sub>2</sub>"  
HF-1519-24

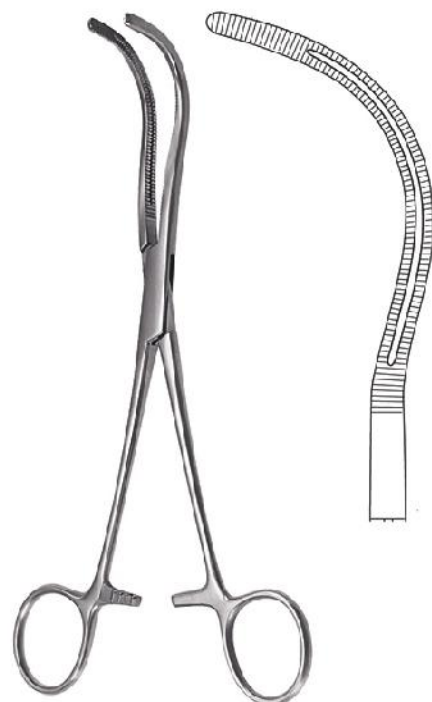

**STILLE**

23,0 cm, 9"  
HF-1511-23

Gallenkanal- und Nierenstiellklemmen, Bronchusklemmen  
 Gall Duct and Kidney Pedicle Clamps, Bronchus Forceps  
 Pinzas-clamps para pedúnculo renal, Pinzas-clamps para bronquios  
 Pinze per peduncoli renali, Pinze per legature

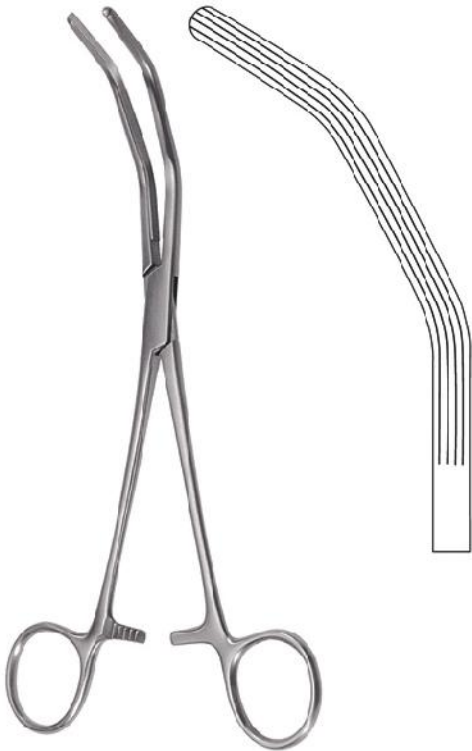

**HERRICK**  
23,0 cm, 9"  
HF-1517-23



**URO-TANGENTIAL**  
26,0 cm, 10 1/4"

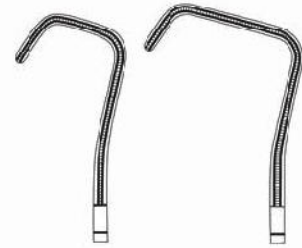

23,0 cm, 9"  
HF-1055-01

24,0 cm, 9 1/2"  
HF-1055-02



**LOVELACE**  
20,0 cm, 8"  
HF-1004-20



**LOVELACE**  
20,0 cm, 8"  
HF-1005-20



**PRICE-THOMAS**  
22,0 cm, 8 3/4"  
HF-1001-22

Bronchusklemmen, Peritoneumklemmen, Hysterektomieklemmen  
 Bronchus Forceps, Peritoneum Forceps, Hysterectomy Forceps  
 Pinzas-clamps para bronquios, Pinzas-clamps para peritoneo y para histerectomia  
 Pinze per legature, Pinze per peritoneo e per isterectomia

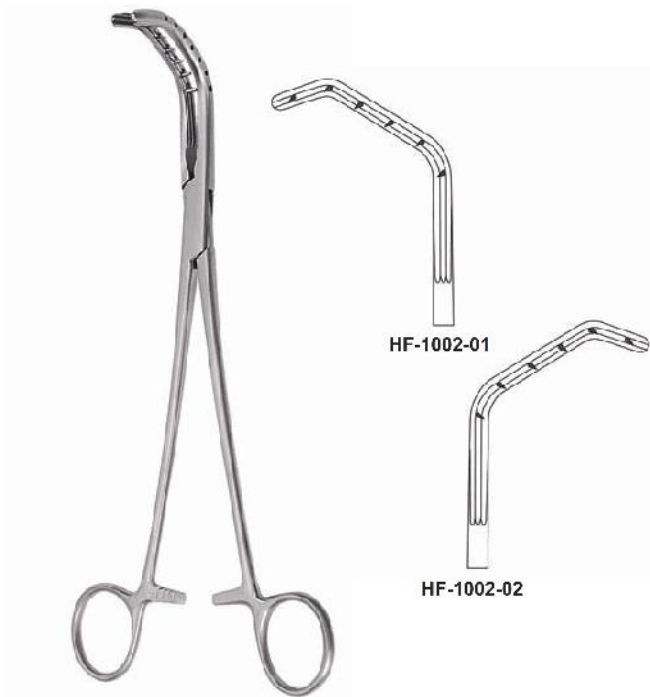

**PRICE-THOMAS**  
 22,0 cm, 8<sup>3</sup>/<sub>4</sub>"

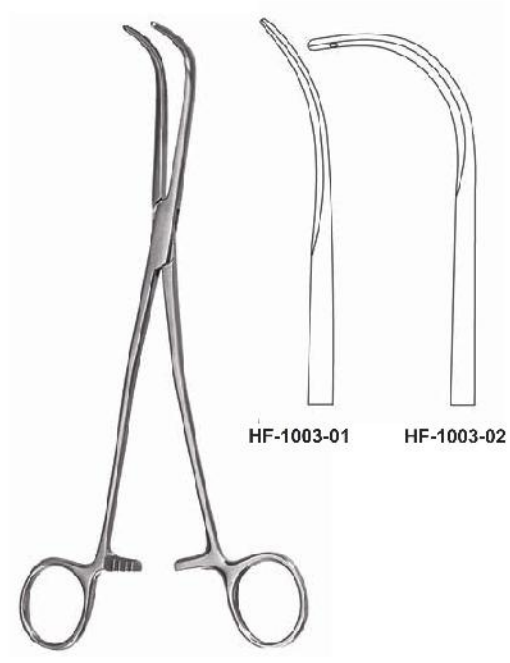

**SEMB**  
 24,0 cm, 9<sup>1</sup>/<sub>2</sub>"

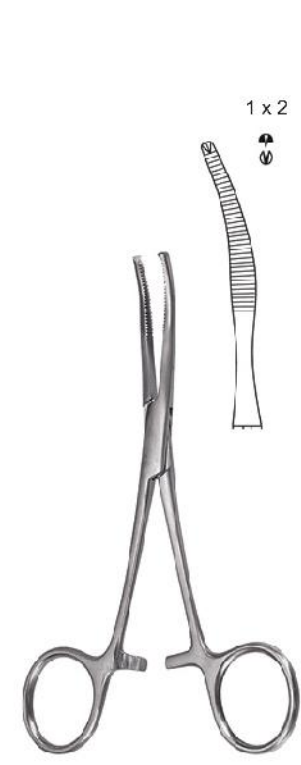

**BABY-MIKULICZ**  
 14,0 cm, 5<sup>1</sup>/<sub>2</sub>"  
 HF-1701-14

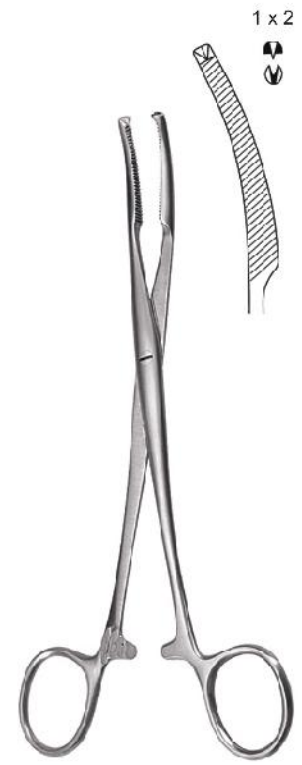

**MIKULICZ**  
 18,0 cm, 7"  
 HF-1703-18



**MIKULICZ**  
 20,0 cm, 8"  
 HF-1709-20

Peritoneumklemmen, Hysterektomieklemmen  
 Peritoeum Forceps, Hysterectomy Forceps  
 Pinzas-clamps para peritoneo y para histerectomía  
 Pinze per peritoneo e per isterectomia

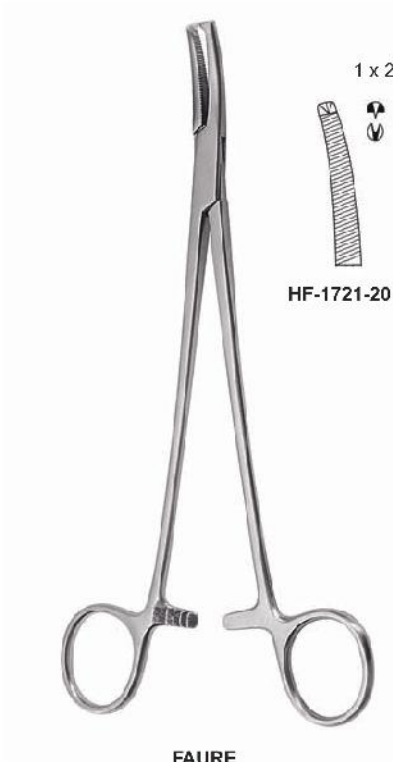

**FAURE**  
20,0 cm, 8"



HF-1721-20



HF-1723-20

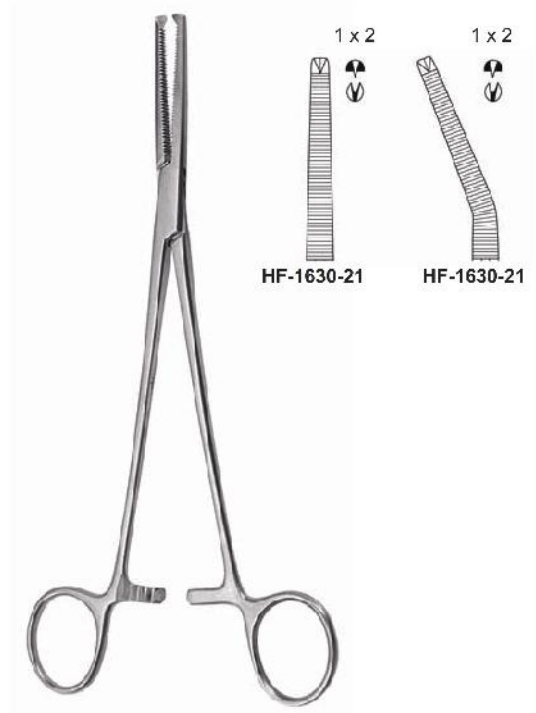

**PHANEUF**  
21,5 cm, 8½"

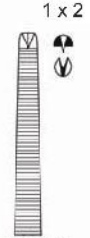

HF-1630-21



HF-1630-21



**WERTHEIM**  
24,0 cm, 9½"  
HF-1601-24



**WERTHEIM**  
25,0 cm, 10"  
HF-1602-25

Hysterektomieklemmen  
 Hysterectomy Forceps  
 Pinzas-clamps para histerectomía  
 Pinze per isterectomia



**WERTHEIM**  
 23,0 cm, 9"

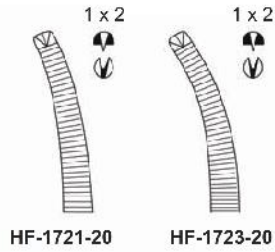

**MAINGOT**  
 21,5 cm, 8½"

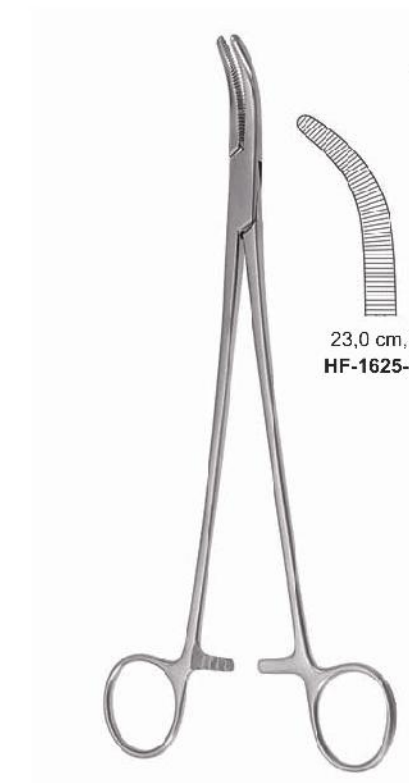
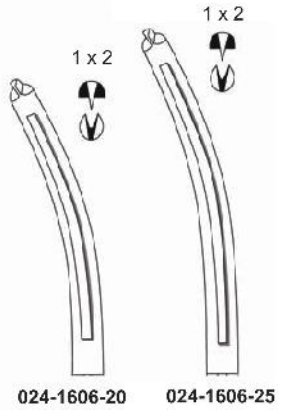

**MOYNIHAN**

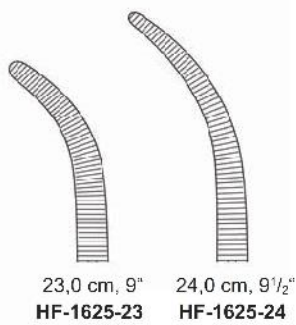

**WERTHEIM-CULLEN**  
 21,5 cm, 8½"  
 HF-1629-21

Hysterektomieklemmen  
Hysterectomy Forceps  
Pinzas-clamps para histerectomía  
Pinze per isterectomia



**LONG**  
19,0 cm, 7<sup>1</sup>/<sub>4</sub>"  
HF-1621-19

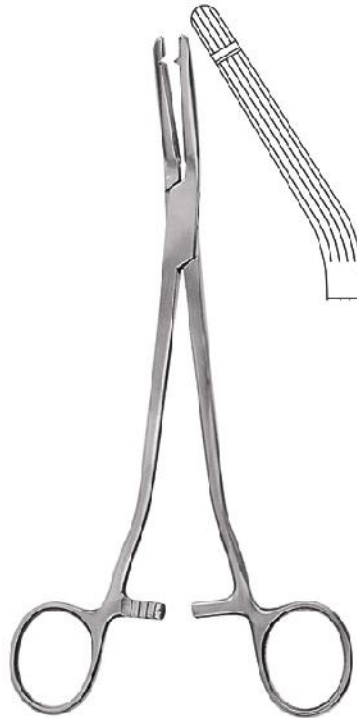

**GARLAND**  
21,0 cm, 8<sup>1</sup>/<sub>4</sub>"  
HF-1623-21



**HEANEY**  
21,0 cm, 8<sup>1</sup>/<sub>4</sub>"  
HF-1607-21

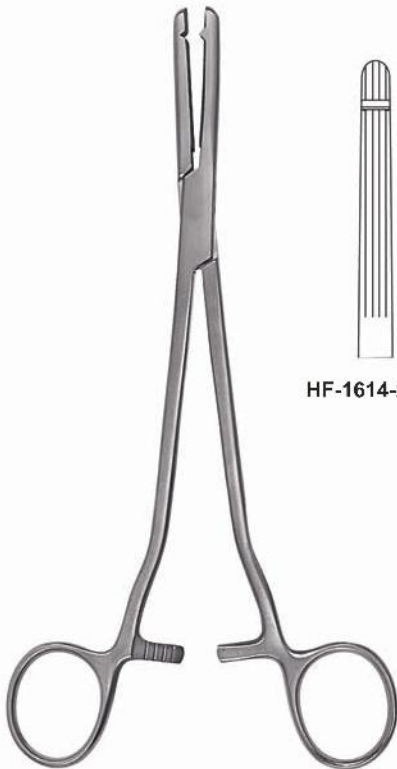

**HEANEY-BALLANTINE**  
21,0 cm, 8<sup>1</sup>/<sub>4</sub>"



HF-1615-21

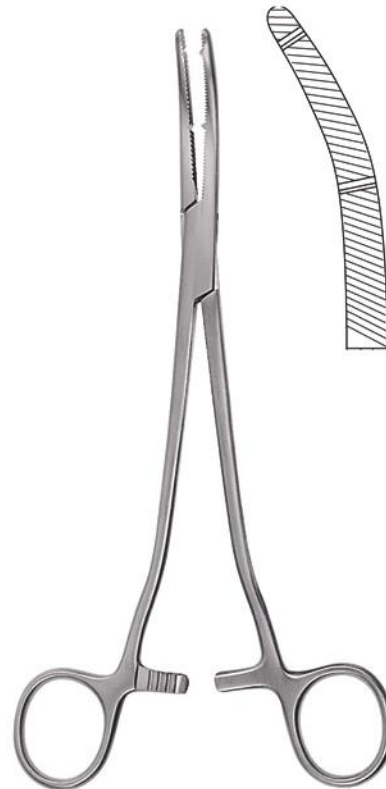

**HEANEY-KANTER**  
21,0 cm, 8<sup>1</sup>/<sub>4</sub>"  
HF-1617-21

Hysterektomieklemmen  
Hysterectomy Forceps  
Pinzas-clamps para histerectomía  
Pinze per isterectomia

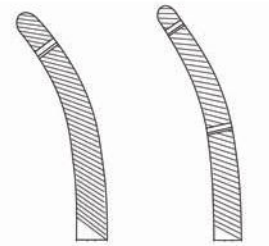

21,0 cm, 8<sup>1</sup>/<sub>4</sub>" HF-1611-21 HF-1613-21  
23,0 cm, 9" HF-1611-23 HF-1613-23





**Nahtinstrumente**  
**Suture Instruments**  
**Instrumentos para sutura**  
**Strumenti per sutura**



Nadelhalter  
Needle Holders  
Porta-agujas  
Portaghi



**DERF**



**NH-1010-12**  
12,0 cm, 4<sup>3</sup>/<sub>4</sub>"



**NH-1020-12**  
12,5 cm, 5"



**COLLIER**  
12,5 cm, 5"  
**NH-1022-12**



**WEBSTER**  
13,0 cm, 5"  
**NH-1028-13**



**HALSEY**  
13,0 cm, 5"



**NH-1030-13**



**NEIVERT**  
13,0 cm, 5"  
**NH-1046-13**



**HEGAR-BAUMGARTNER**  
14,0 cm, 5<sup>1</sup>/<sub>2</sub>"  
**NH-1048-14**



Nadelhalter  
Needle Holders  
Porta-agujas  
Portaghi



**NH-1096-13**  
13,0 cm, 5"

**BROWN**



**CRILE-MURRAY**  
15,0 cm, 6"  
**NH-1070-15**



**NH-1060-15**  
15,0 cm, 6"

**CRILE-WOOD**



**ADSON**  
18,0 cm, 7"  
**NH-1192-18**



**METZENBAUM**  
18,0 cm, 7"  
**NH-1190-18**



**MASS.-GENERAL-HOSPITAL**  
17,0 cm, 6<sup>3</sup>/<sub>4</sub>"  
**NH-1072-17**

Nadelhalter  
Needle Holders  
Porta-agujas  
Portaghi



**MAYO-HEGAR**



NH-1080-14



NH-1080-16



NH-1080-18



NH-1080-20



NH-1080-24



NH-1080-26



NH-1080-30



**MAYO-HEGAR-DELICATE**



NH-1090-16  
16,0 cm, 6 1/4"



NH-1090-18  
18,0 cm, 7"



NH-1090-20  
20,0 cm, 8"



**LAWRENCE**  
15,0 cm, 6"  
NH-1110-15

Nadelhalter  
Needle Holders  
Porta-agujas  
Portaghi



**HEANEY**  
21,0 cm, 8<sup>1</sup>/<sub>4</sub>"  
NH-1141-21



**JAMISON**  
23,5 cm, 9<sup>1</sup>/<sub>2</sub>"  
NH-1148-23



**MASSON**  
27,0 cm, 10<sup>1</sup>/<sub>2</sub>"  
NH-1150-27



**FINOCCHIETTO**  
27,0 cm, 10<sup>1</sup>/<sub>2</sub>"  
NH-1211-27



**WANGENSTEEN**  
27,0 cm, 10<sup>1</sup>/<sub>2</sub>"  
NH-1160-27



**JOHNSON**  
27,0 cm, 10<sup>1</sup>/<sub>2</sub>"  
NH-1193-27

Nadelhalter  
Needle Holders  
Porta-agujas  
Portaghi

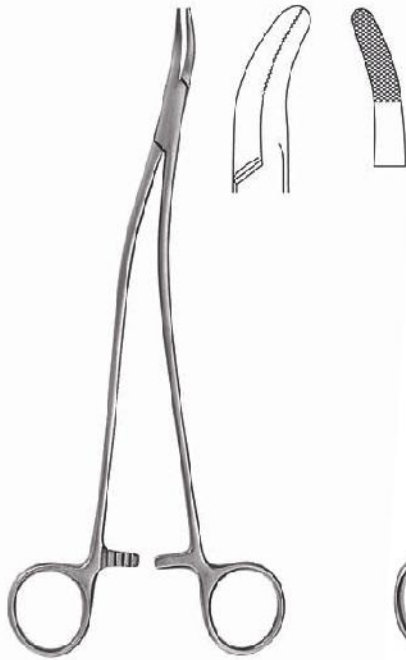

**STRATTE**  
23,0 cm, 9"  
NH-1230-23



**OLSEN-HEGAR**  
17,0 cm, 6 $\frac{3}{4}$ "  
NH-1310-17

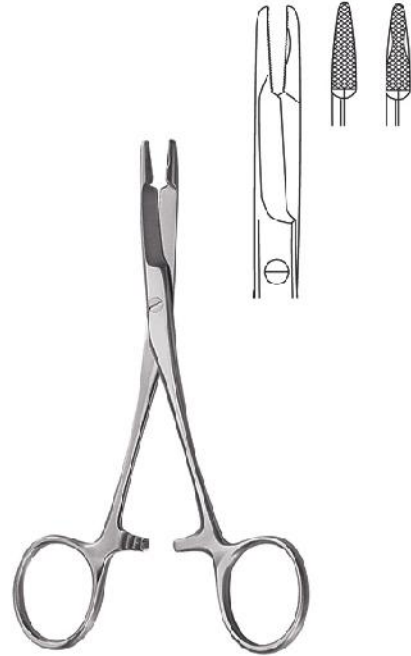

**OLSEN-HEGAR**  
14,0 cm, 5 $\frac{1}{2}$ "  
NH-1306-14



14,0 cm, 5 $\frac{1}{2}$ "  
NH-1310-14

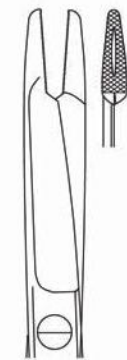

18,0 cm, 7"  
NH-1310-18

**OLSEN-HEGAR**



**TOENNIS**  
18,0 cm, 7"  
NH-1362-18

Nadelhalter  
Needle Holders  
Porta-agujas  
Portaghi



MATHIEU



**NH-1350-14**  
14,0 cm, 5½"



**NH-1350-17**  
17,0 cm, 6¾"



**NH-1350-20**  
20,0 cm, 8"



MATHIEU



**NH-1356-17**  
17,0 cm, 6¾"



**NH-1356-20**  
20,0 cm, 8"



LICHTENBERG  
20,0 cm, 8"  
NH-1366-20



MATHIEU



**NH-1354-14**  
14,0 cm, 5½"



**NH-1354-17**  
17,0 cm, 6¾"

Nadelhalter, Mikro-Nadelhalter  
 Needle Holders, Micro Needle Holders  
 Porta-agujas, Micro Porta-agujas  
 Portaghi, Micro Portaghi



**MATHIEU-KOCHER**



**NH-1358-14**  
 14,0 cm, 5½"



**NH-1358-17**  
 17,0 cm, 6¾"



**NH-1358-20**  
 20,0 cm, 8"



**BARRAQUER-TROUTMAN**  
 10,0 cm, 4"



**NH-1550-10**



**NH-1551-10**



**BARRAQUER**



**NH-1550-10**



**NH-1551-10**



**BARRAQUER**  
 13,5 cm, 5⅜"  
**NH-1621-13**



**GOMEL**  
 14,0 cm, 5½"  
**NH-1601-14**





Mikro-Nadelhalter  
Micro Needle Holders  
Micro Porta-agujas  
Micro Portaghi



NH-1600-18 NH-1601-18



ohne Sperre  
without ratchet  
sin cremallera  
senza cremagliera

18,5 cm, 7<sup>1</sup>/<sub>4</sub>"



NH-1630-18 NH-1631-18



mit Sperre  
with ratchet  
con cremallera  
con cremagliera

18,5 cm, 7<sup>1</sup>/<sub>4</sub>"



NH-1570-14



NH-1571-14

NH-1576-14



NH-1577-14

mit Sperre  
with ratchet  
con cremallera  
con cremagliera

**CASTROVIEJO**  
14,5 cm, 5<sup>3</sup>/<sub>4</sub>"



NH-1570-18



NH-1571-18

NH-1576-18



NH-1577-18

mit Sperre  
with ratchet  
con cremallera  
con cremagliera

**CASTROVIEJO**  
18,0 cm, 7"

**Mikro-Nadelhalter**  
**Micro Needle Holders**  
**Micro Porta-agujas**  
**Micro Portaghi**

0,4 mm



gerade, ohne Sperre  
 straight, without ratchet  
 recta, sin cremallera  
 retta, senza cremagliera

14,0 cm, 5 1/2"  
**NH-1650-14**

0,4 mm



gebogen, ohne Sperre  
 curved, without ratchet  
 curva, sin cremallera  
 curva, senza cremagliera

14,0 cm, 5 1/2"  
**NH-1651-14**

0,4 mm



14,0 cm, 5 1/2"  
**NH-1653-14**

0,5 mm



gebogen, ohne Sperre  
 curved, without ratchet  
 curva, sin cremallera  
 curva, senza cremagliera

Ø 10 mm

14,0 cm, 5 1/2"  
**NH-1661-14**

0,5 mm



gebogen, ohne Sperre  
 curved, without ratchet  
 curva, sin cremallera  
 curva, senza cremagliera

Ø 10 mm

14,0 cm, 5 1/2"  
**NH-1663-14**

0,4 mm



gebogen, ohne Sperre  
 curved, without ratchet  
 curva, sin cremallera  
 curva, senza cremagliera

Ø 8 mm

13,0 cm, 5"  
**NH-1671-13**

0,4 mm



gebogen, ohne Sperre  
 curved, without ratchet  
 curva, sin cremallera  
 curva, senza cremagliera

Ø 8 mm

13,0 cm, 5"  
**NH-1673-13**

Nadelhalter mit Hartmetalleinlagen  
 Needle Holders with tungsten carbide inserts  
 Porta-agujas con bocas de carburo tungsteno  
 Portaghi con morsi in carburo di tungsteno



**KALT**  
 13,5 cm, 5<sup>3</sup>/<sub>8</sub>"  
 TC-428-14



**DIETHRICH**

- |   |            |
|---|------------|
| 16,0 cm, 5 <sup>3</sup> / <sub>8</sub> "  | TC-1250-16 |
| 18,0 cm, 7"                               | TC-1250-18 |
| 20,0 cm, 8"                               | TC-1250-20 |
| 23,0 cm, 9"                               | TC-1250-23 |
| 26,0 cm, 10 <sup>1</sup> / <sub>4</sub> " | TC-1250-26 |



**WEBSTER**  
 13,0 cm, 5"  
 TC-028-13



**DERF**  
 12,0 cm, 4<sup>3</sup>/<sub>4</sub>"  
 TC-1010-12



**HEGAR-BAUMGARTNER**

**TC-1048-12**  
 12,5 cm, 5"

**TC-1048-14**  
 14,0 cm, 5<sup>1</sup>/<sub>2</sub>"



**WEBSTER**  
 13,0 cm, 5"  
 TC-1029-13

Nadelhalter mit Hartmetalleinlagen  
 Needle Holders with tungsten carbide inserts  
 Porta-agujas con bocas de carburo tungsteno  
 Portaghi con morsi in carburo di tungsteno



**HALSEY**  
 13,0 cm, 5"

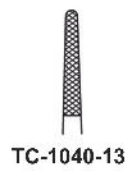

**CRILE-WOOD**

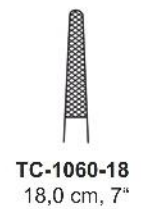
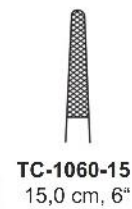

**SAROT**

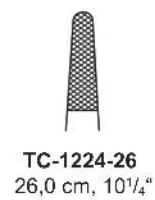

Nadelhalter mit Hartmetalleinlagen  
Needle Holders with tungsten carbide inserts  
Porta-agujas con bocas de carburo tungsteno  
Portaghi con morsi in carburo di tungsteno



**MAYO-HEGAR**



**TC-1080-16**  
16,0 cm, 6 1/4"



**TC-1080-18**  
18,0 cm, 7"



**TC-1080-20**  
20,0 cm, 8"



**TC-1080-24**  
24,0 cm, 9 1/2"



**TC-1080-26**  
26,0 cm, 10 1/4"



**TC-1080-30**  
30,0 cm, 12"



**MAYO-HEGAR (HEANEY)**



**TC-1141-20**  
20,0 cm, 8"



**TC-1141-24**  
24,0 cm, 9 1/4"



**TC-1141-26**  
26,0 cm, 10 1/4"

Nadelhalter mit Hartmetalleinlagen  
 Needle Holders with tungsten carbide inserts  
 Porta-agujas con bocas de carburo tungsteno  
 Portaghi con morsi in carburo di tungsteno

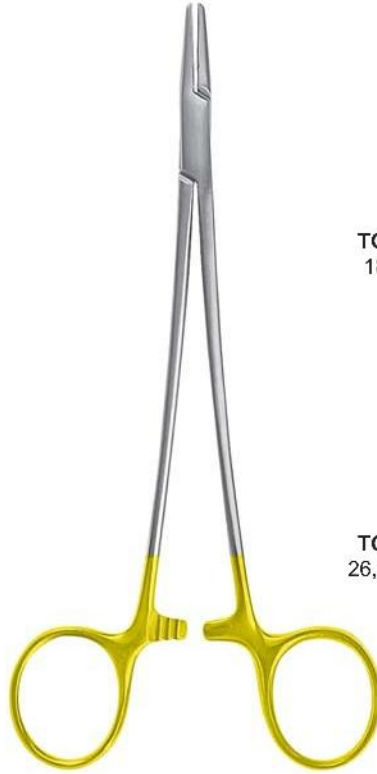

DE BAKEY



TC-1114-18  
18,0 cm, 7"



TC-1114-20  
20,0 cm, 8"



TC-1114-23  
23,0 cm, 9"



TC-1114-26  
26,0 cm, 10<sup>1</sup>/<sub>4</sub>"



TC-1114-31  
31,0 cm, 12<sup>1</sup>/<sub>4</sub>"



TC-1114-37  
37,0 cm, 14<sup>1</sup>/<sub>2</sub>"

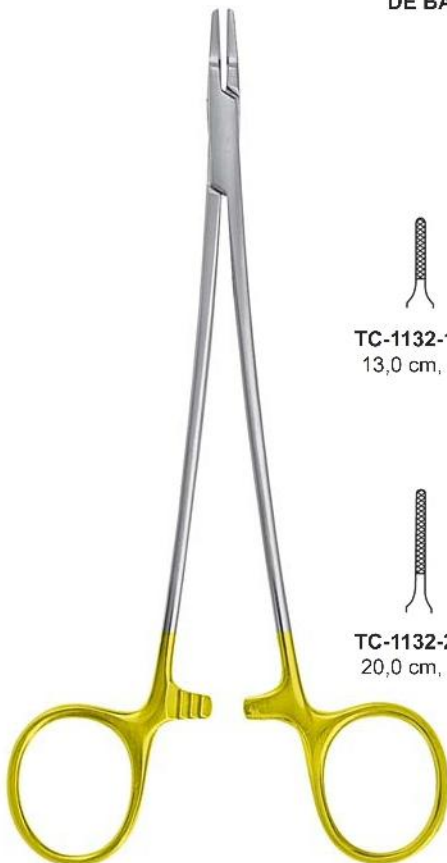

RYDER-VASCULAR

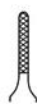

TC-1132-13  
13,0 cm, 5"



TC-1132-15  
15,0 cm, 6"

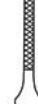

TC-1132-18  
18,0 cm, 7"

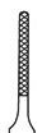

TC-1132-20  
20,0 cm, 8"



TC-1132-23  
23,0 cm, 9"



TC-1132-26  
26,0 cm, 10<sup>1</sup>/<sub>4</sub>"

Nadelhalter mit Hartmetalleinlagen  
Needle Holders with tungsten carbide inserts  
Porta-agujas con bocas de carburo tungsteno  
Portaghi con morsi in carburo di tungsteno

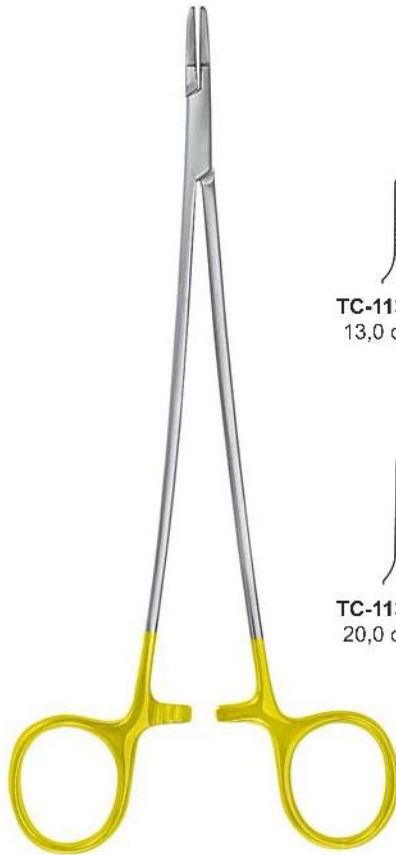

**RYDER**

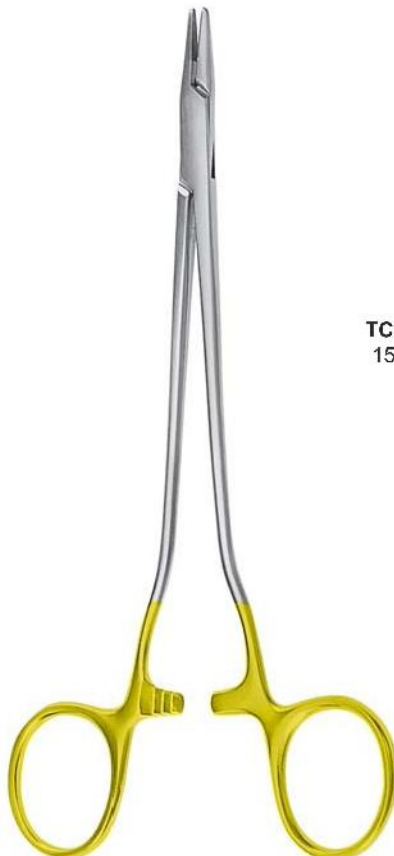
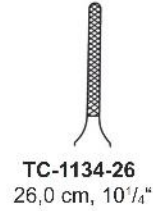
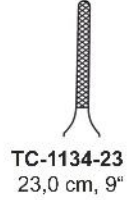
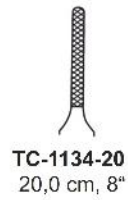
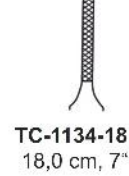
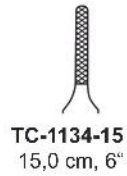
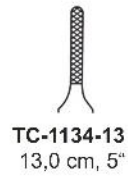

**SCHWEDISCHES MODELL**

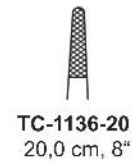
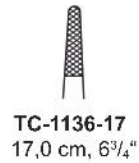
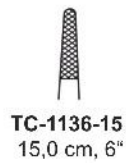

Nadelhalter mit Hartmetalleinlagen  
 Needle Holders with tungsten carbide inserts  
 Porta-agujas con bocas de carburo tungsteno  
 Portaghi con morsi in carburo di tungsteno

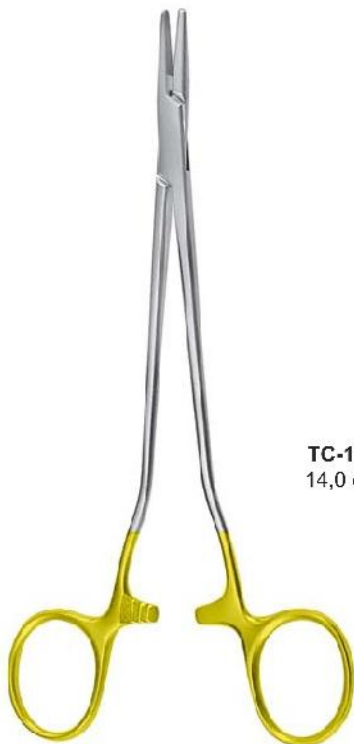

MAYO-HEGAR (HEANEY)



TC-1090-14  
 14,0 cm, 5½"



TC-1090-18  
 18,0 cm, 7"



TC-1090-20  
 20,0 cm, 8"



TC-1090-23  
 23,0 cm, 9"



FINOCCHIETTO  
 27,0 cm, 10½"  
 TC-1211-27



MASSON  
 27,0 cm, 10½"  
 TC-1150-27



WANGENSTEEN  
 27,0 cm, 10½"  
 026-1160-27



Nadelhalter mit Hartmetalleinlagen  
Needle Holders with tungsten carbide inserts  
Porta-agujas con bocas de carburo tungsteno  
Portaghi con morsi in carburo di tungsteno



**BOZEMANN**



**TC-1185-20**  
20,0 cm, 8"



**TC-1185-24**  
24,0 cm, 9<sup>5</sup>/<sub>8</sub>"



**026-1185-26**  
26,0 cm, 10<sup>1</sup>/<sub>4</sub>"



**HEGAR**



**TC-1084-20**  
20,0 cm, 8"



**TC-1084-24**  
24,0 cm, 9<sup>5</sup>/<sub>8</sub>"



**BARRY STERNAL**



**TC-1240-15**  
15,0 cm, 6"



**TC-1242-20**  
20,0 cm, 8"

Nadelhalter mit Hartmetalleinlagen  
 Needle Holders with tungsten carbide inserts  
 Porta-agujas con bocas de carburo tungsteno  
 Portaghi con morsi in carburo di tungsteno



**STRATTE**

**TC-1230-22**  
 22,0 cm, 8<sup>5</sup>/<sub>8</sub>"

**TC**  
 23



**GILLIES**  
 16,0 cm, 6<sup>1</sup>/<sub>4</sub>"  
**TC-1330-16**



**OLSEN-HEGAR**

**TC-1310-14**  
 14,0 cm, 5<sup>1</sup>/<sub>2</sub>"

**TC-1310-17**  
 17,0 cm, 6<sup>3</sup>/<sub>4</sub>"

**TC-1310-18**  
 18,0 cm, 7"



**TOENNIS**  
 18,0 cm, 7"  
**TC-1362-18**

Nadelhalter mit Hartmetalleinlagen  
Needle Holders with tungsten carbide inserts  
Porta-agujas con bocas de carburo tungsteno  
Portaghi con morsi in carburo di tungsteno



MATHIEU-KOCHER



**TC-1358-14**  
14,0 cm, 5½"



**TC-1358-17**  
17,0 cm, 6¾"



**TC-1358-20**  
20,0 cm, 8"



MATHIEU



**TC-1350-14**  
14,0 cm, 5½"



**TC-1350-17**  
17,0 cm, 6¾"



**TC-1350-20**  
20,0 cm, 8"

Nadelhalter mit Hartmetalleinlagen  
Needle Holders with tungsten carbide inlays  
Porta-agujas con bocas de carburo tungsteno  
Portaghi con morsi in carburo di tungsteno



**TC-1366-17**  
17,0 cm, 6<sup>3</sup>/<sub>4</sub>"

**TC-1366-20**  
20,0 cm, 8"

**LICHTENBERG**



**TC-1356-17**  
17,0 cm, 6<sup>3</sup>/<sub>4</sub>"

**TC-1356-20**  
20,0 cm, 8"

**TC-1356-23**  
23,0 cm, 9"

**MATHIEU**

Nadelhalter mit Hartmetalleinlagen  
Needle Holders with tungsten carbide inserts  
Porta-agujas con bocas de carburo tungsteno  
Portaghi con morsi in carburo di tungsteno



ZWEIFEL



**TC-1364-20**  
20,0 cm, 8"



**TC-1364-23**  
23,0 cm, 9"



LANGENBECK



**TC-1360-18**  
18,0 cm, 7"



**TC-1360-20**  
20,0 cm, 8"



**TC-1360-23**  
23,0 cm, 9"



**v-1360-18**  
18,0 cm, 7"



**TC-1360-20**  
20,0 cm, 8"



**TC-1360-23**  
23,0 cm, 9"

Nadelhalter mit Hartmetalleinlagen  
 Needle Holders with tungsten carbide inserts  
 Porta-agujas con bocas de carburo tungsteno  
 Portaghi con morsi in carburo di tungsteno

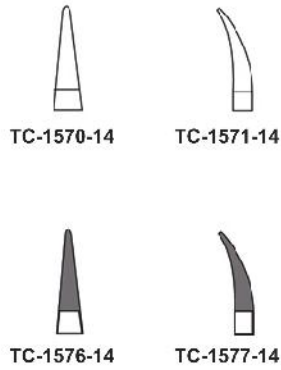

mit Sperre  
 with ratchet  
 con cremallera  
 con cremagliera

**CASTROVIEJO**  
 14,5 cm, 5<sup>3</sup>/<sub>4</sub>"

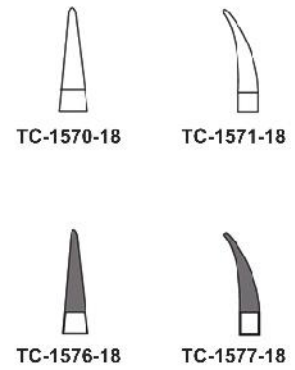

mit Sperre  
 with ratchet  
 con cremallera  
 con cremagliera

**CASTROVIEJO**  
 18,0 cm, 7"

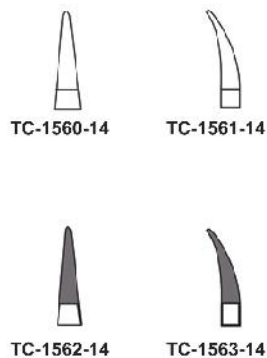

mit Sperre  
 with ratchet  
 con cremallera  
 con cremagliera

**BARRAQUER**  
 14,5 cm, 5<sup>3</sup>/<sub>4</sub>"



**HEPP SCHEIDEL**  
 18,0 cm, 7"  
 TC-1390-18

REVERDIN-Nadeln  
REVERDIN Needles  
Agujas de REVERDIN  
Aghi di REVERDIN



**REVERDIN**  
14,0 cm, 5<sup>1</sup>/<sub>2</sub>"

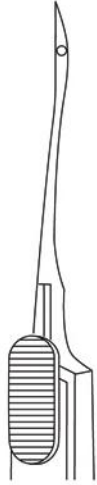

RN-1211-01

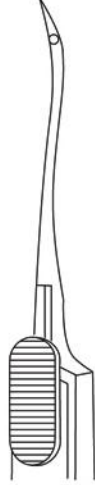

RN-1211-02



RN-1211-03

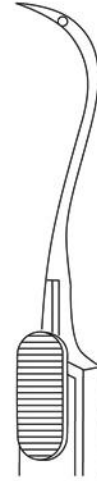

RN-1211-04



**REVERDIN**

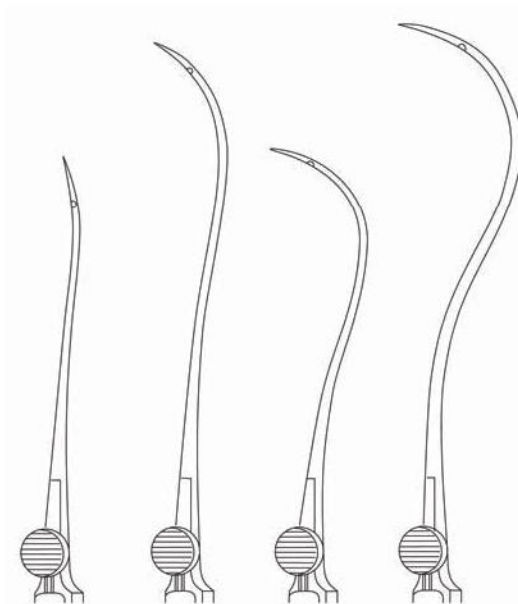

19,5 cm, 7<sup>3</sup>/<sub>4</sub>" RN-1221-01 RN-1221-02 RN-1221-03 RN-1221-04  
22,5 cm, 8<sup>3</sup>/<sub>4</sub>" RN-1223-01 RN-1223-02 RN-1223-03 RN-1223-04

Unterbindungsnaedeln  
Ligature Needles  
Agujas para ligaduras  
Aghi per legatura

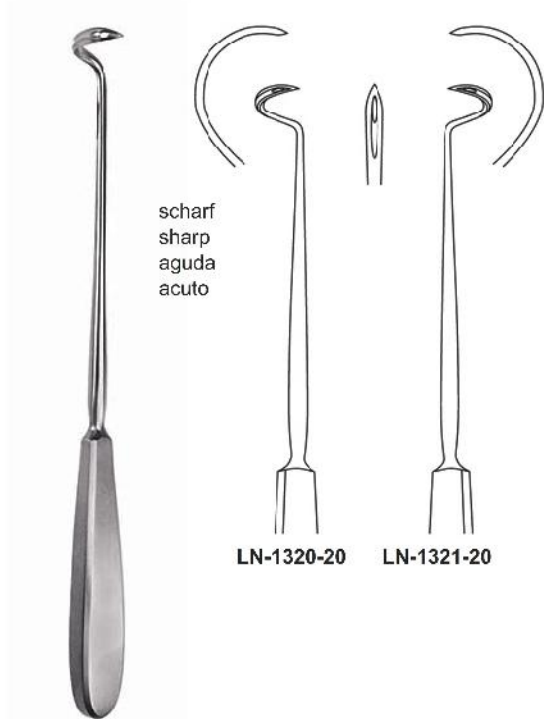

scharf  
sharp  
aguda  
acuto

LN-1320-20

LN-1321-20

**DESCHAMPS**  
20,0 cm, 8"

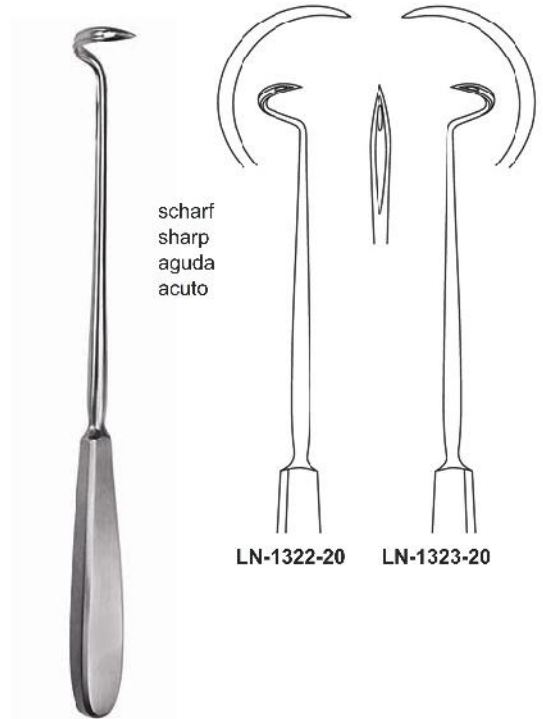

scharf  
sharp  
aguda  
acuto

LN-1322-20

LN-1323-20

**DESCHAMPS**  
20,0 cm, 8"

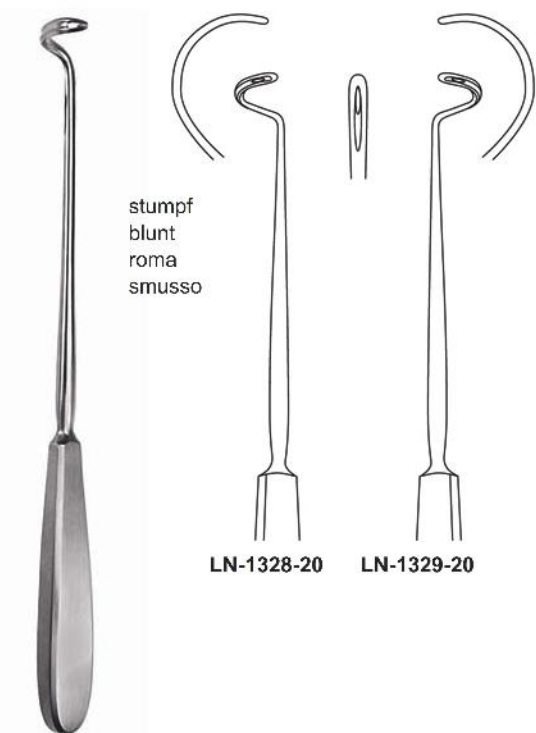

stumpf  
blunt  
roma  
smusso

LN-1328-20

LN-1329-20

**DESCHAMPS**  
20,0 cm, 8"

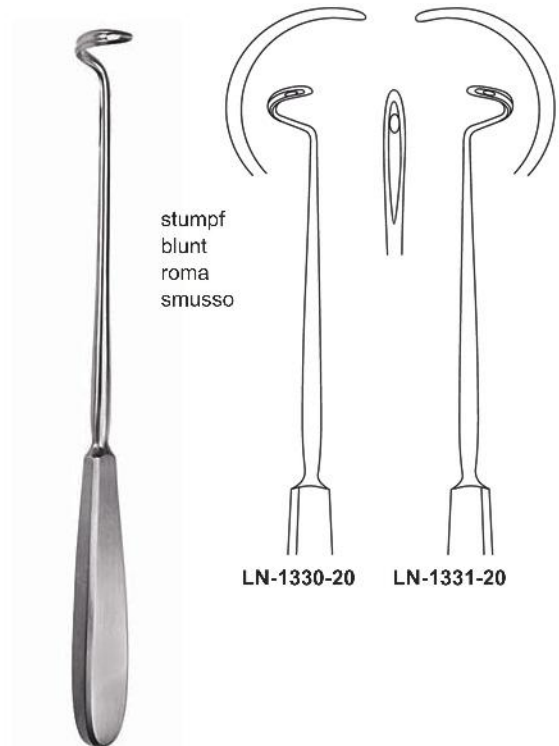

stumpf  
blunt  
roma  
smusso

LN-1330-20

LN-1331-20

**DESCHAMPS**  
20,0 cm, 8"



Unterbindungsnadeln  
Ligature Needles  
Agujas para ligaduras  
Aghi per legatura



scharf  
sharp  
aguda  
acuto

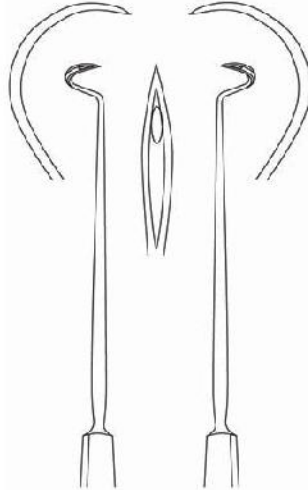

21,0 cm, 8<sup>1</sup>/<sub>4</sub>" LN-1324-21 LN-1325-21  
27,0 cm, 10<sup>5</sup>/<sub>8</sub>" LN-1324-27 LN-1325-27

DESCHAMPS



stumpf  
blunt  
roma  
smusso

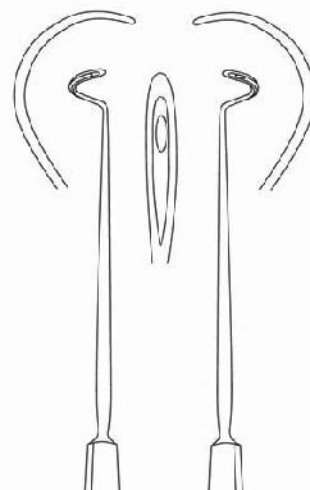

21,0 cm, 8<sup>1</sup>/<sub>4</sub>" LN-1332-21 LN-1333-21  
27,0 cm, 10<sup>5</sup>/<sub>8</sub>" LN-1332-27 LN-1333-27

DESCHAMPS



biegsam  
malleable  
maleable  
malleabile

20,0 cm, 8"  
LN-1450-20

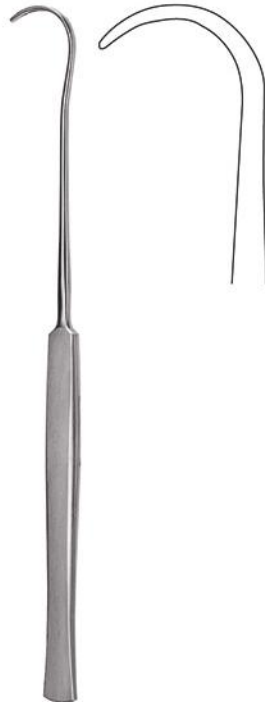

COOPER  
19,0 cm, 7<sup>1</sup>/<sub>2</sub>"  
LN-1451-19



COOPER  
20,0 cm, 8"  
LN-1451-20



SYME  
15,0 cm, 6"  
LN-1453-15

Unterbindungsnadeln  
Ligature Needles  
Agujas para ligaduras  
Aghi per li



**KOCHER**  
19,0 cm, 7 1/2"



LN-1452-01



LN-1452-02



LN-1452-03



**BRUNNER**  
25,0 cm, 9 3/4"  
LN-1455-25



**BRUNNER**  
30,0 cm, 11 3/4"



LN-1454-01



LN-1454-02



**SCHMIEDEN**  
21,0 cm, 8 1/4"  
LN-1458-21

Unterbindungsnadeln  
Ligature Needles  
Agujas para ligaduras  
Aghi per legatura



**YOUNG-HRYNTSCHAK**  
24,0 cm, 9 1/2"  
LN-1460-24



LN-1460-01



LN-1460-02

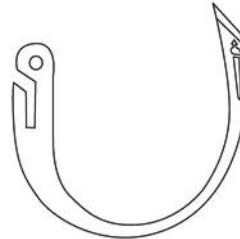

LN-1460-03



**DE LA ROZA**  
12,0 cm, 4 3/8"  
LN-1467-01



**DE LA ROZA**  
12,0 cm, 4 3/8"  
LN-1467-02



**JAKOBI**  
14,0 cm, 5 1/2"  
LN-1469-14



**HESSEBERG**  
15,0 cm, 6"  
LN-1468-15



**KRONECKER**  
15,0 cm, 6"  
LN-1470-01

Unterbindungsadeln  
 Ligature Needles  
 Aguja para ligaduras  
 Aghi per legatura



**KRONECKER**  
 15,0 cm, 6"  
 LN-1470-02



**TRÉLAT**  
 23,0 cm, 9"  
 LN-1472-23



**CLAUS**  
 23,0 cm, 9"  
 LN-1473-23



**HURD**  
 21,0 cm, 8 1/4"  
 LN-1474-01



**HURD**  
 21,0 cm, 8 1/4"  
 LN-1474-02



**NAGER**  
 24,0 cm, 9 1/2"  
 LN-1477-24



**CLAUS-EICKEN**  
 23,0 cm, 9"  
 LN-1481-23



**FALK**  
 24,0 cm, 9 1/2"  
 LN-1480-01



**FALK**  
 24,0 cm, 9 1/2"  
 LN-1480-02

Führungshohlsonden  
Ligature Conductors  
Sondas conductoras  
Sonde conduttrici

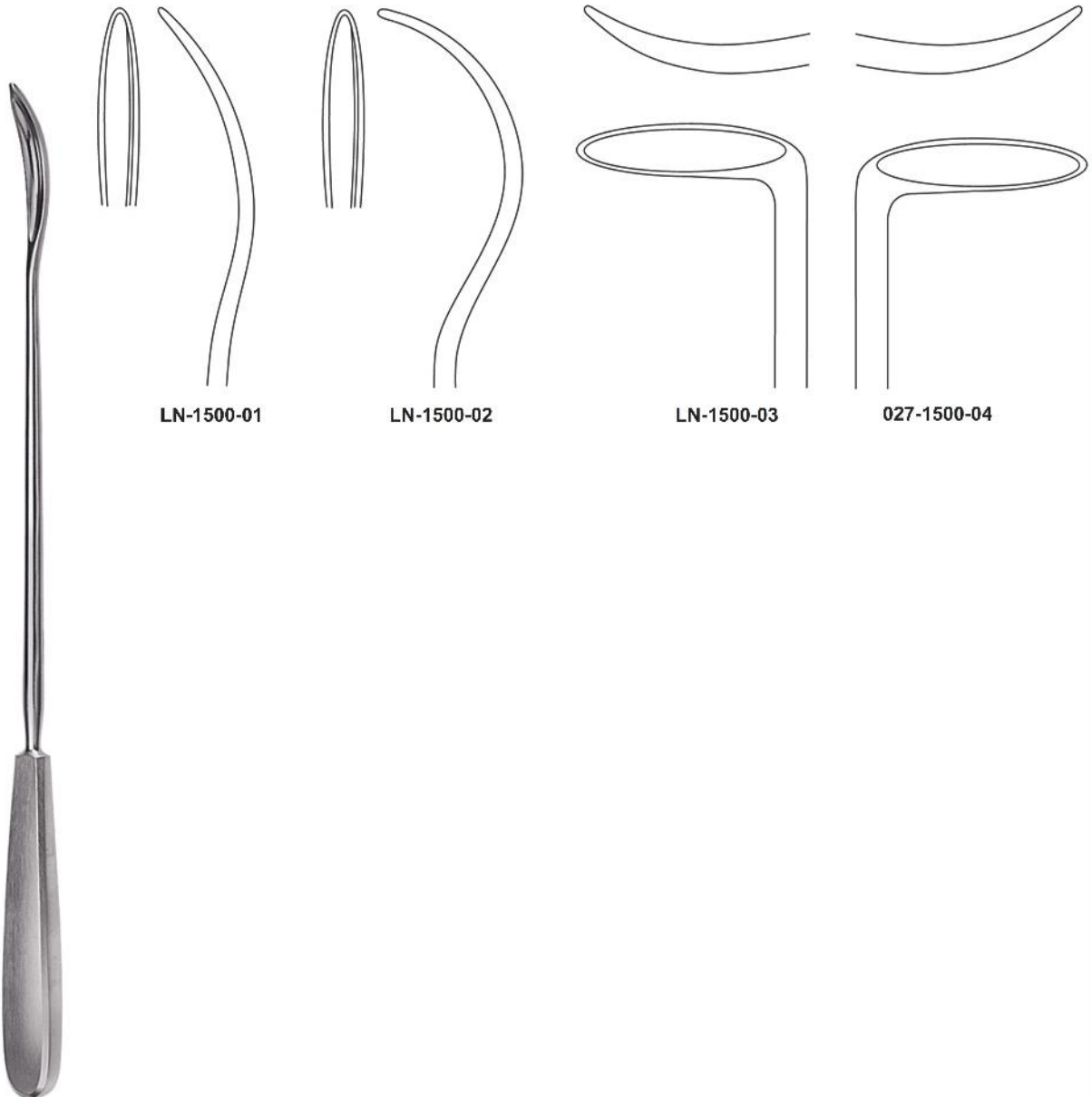

**BRUNNER**  
30,0 cm, 11<sup>3</sup>/<sub>4</sub>"

Führungshohlsonden  
Ligature Conductors  
Sondas conductoras  
Sonde conduttrici



**PAYR**  
22,0 cm, 8<sup>5</sup>/<sub>8</sub>"  
LN-1502-22



**PAYR**  
22,0 cm, 8<sup>5</sup>/<sub>8</sub>"  
LN-1503-22



mit Loch  
with hole  
con foro  
con ago

**SCHMIEDEN-PAYR**  
19,0 cm, 7<sup>1</sup>/<sub>2</sub>"  
LN-1506-19



ohne Loch  
without hole  
sin foro  
senza ago

**SCHMIEDEN**  
19,0 cm, 7<sup>1</sup>/<sub>2</sub>"  
027-1507-19



**KÖNIG**  
19,5 cm, 7<sup>3</sup>/<sub>4</sub>"  
LN-1508-03



**KÖNIG**  
19,5 cm, 7<sup>3</sup>/<sub>4</sub>"  
LN-1508-05



**KÖNIG**  
19,5 cm, 7<sup>3</sup>/<sub>4</sub>"  
LN-1508-07

Führungshohlsonden  
Ligature Conductors  
Sondas conductoras  
Sonde conduttrici

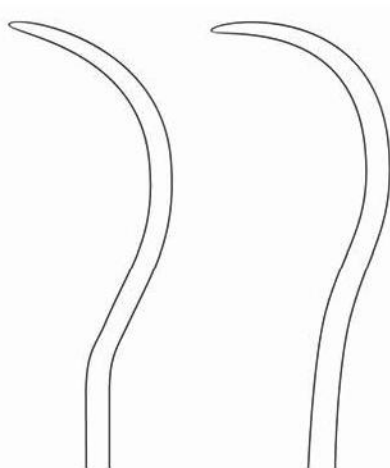

25,5 cm, 10"  
v-1510-25

28,0 cm, 11"  
LN-1510-28

**KIRSCHNER**



**BRUNNER-FERROZELL**  
18,0 cm, 7" LN-1521-18  
27,0 cm, 10<sup>5</sup>/<sub>8</sub>" LN-1521-27

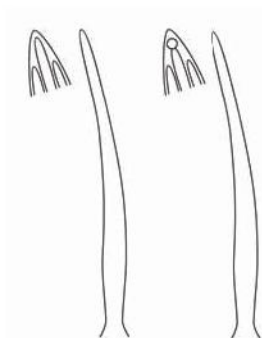

15,0 cm, 6" LN-1513-15 LN-1514-15  
16,0 cm, 6<sup>1</sup>/<sub>4</sub>" LN-1513-16 LN-1514-16



18,0 cm, 7"  
LN-1516-18

**KOCHER**

Nahtinstrumente  
Suture Instruments  
Instrumentos para sutura  
Strumenti per sutura



**MOD. WIEN**  
23,5 cm, 9<sup>1</sup>/<sub>4</sub>"  
LN-1532-23



**BOZEMANN**  
21,0 cm, 8<sup>1</sup>/<sub>4</sub>"  
LN-1531-21



23,0 cm, 9"  
LN-1530-23



**MICHEL**  
12,0 cm, 4<sup>3</sup>/<sub>4</sub>"  
027-1550-12



**COLLIN**  
13,0 cm, 5"  
LN-1552-13

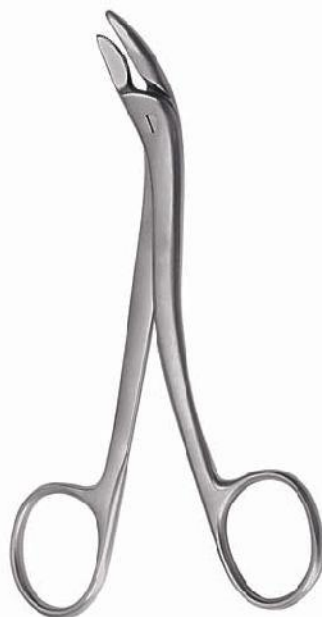

**RICHTER-HEATH**  
14,0 cm, 5<sup>1</sup>/<sub>2</sub>"  
LN-1553-14



**WACHENFELDT**  
12,5 cm, 5"  
LN-1555-01



**HEGENBARTH**  
12,5 cm, 5"  
LN-1556-12



Nahinstrumente  
Suture Instruments  
Instrumentos para sutura  
Strumenti per sutura



**MICHEL**  
12,0 cm, 4<sup>3/8</sup>"  
LN-1558-12



**LANGE**  
10,0 cm, 4"  
LN-1559-10



**CHILDE**  
18,0 cm, 7"  
LN-1560-01



**CHILDE**  
18,0 cm, 7"  
LN-1560-02



LN-1570-08 7,5 x 1,75 mm



LN-1570-11 11,0 x 2,0 mm



LN-1570-12 12,0 x 3,0 mm



LN-1570-14 14,0 x 3,0 mm



LN-1570-16 16,0 x 3,0 mm



LN-1570-18 18,0 x 3,0 mm



LN-1570-20 20,0 x 3,0 mm



LN-1570-22 22,0 x 3,0 mm

**MICHEL**



**CLIP-SET**  
056-558-00

bestehend aus, consisting of, compuesto de, composto da

- 1 x LN-1558-12
- 1 x LN-1550-12
- 50 x LN-1570-14
- 1 x LN-1590-01 (Etui)



**Wundhaken**  
**Retractors**  
**Separadores**  
**Divaricatori**



Dura- und Hauthäkchen  
 Dura and Skin Retractors  
 Gancho para piel y dura-madre  
 Unico per pelle e dura-madre



**GILLIES**  
 18,0 cm, 7"



Fig. 1  
 RT-1050-01



Fig. 2  
 RT-1050-02



**KILNER**  
 15,0 cm, 6"  
 RT-1054-15



**FRAZIER**  
 13,0 cm, 5"  
 RT-1060-13



**O'CONNOR**  
 16,0 cm, 6 1/4"  
 RT-1074-16



**KLEINERT-KUTZ**  
 16,0 cm, 6 1/4"



Fig. 1  
 RT-1058-01



Fig. 2  
 RT-1058-02



Fig. 3  
 RT-1058-03



**JOSEPH**  
 16,0 cm, 6 1/4"  
 RT-1062-16



**GRAEFE**  
 16,0 cm, 6 1/4"



Fig. 1  
 RT-1078-01



Fig. 2  
 v-1078-02

Dura- und Hauthäkchen  
Dura and Skin Retractors  
Gancho para piel y dura-madre  
Unico per pelle e dura-madre

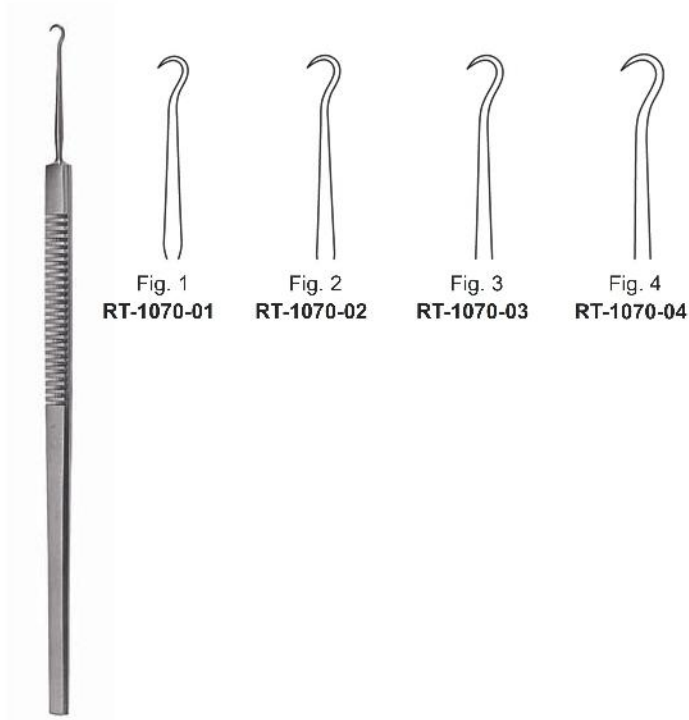

Fig. 1 RT-1070-01  
Fig. 2 RT-1070-02  
Fig. 3 RT-1070-03  
Fig. 4 RT-1070-04

16,0 cm, 6 1/4"

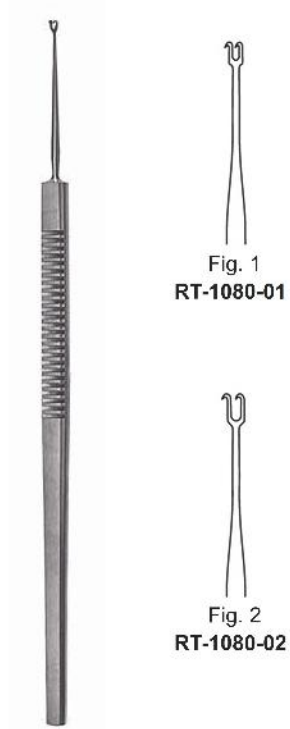

Fig. 1  
RT-1080-01

Fig. 2  
RT-1080-02

**GUTHRIE**  
16,0 cm, 6 1/4"

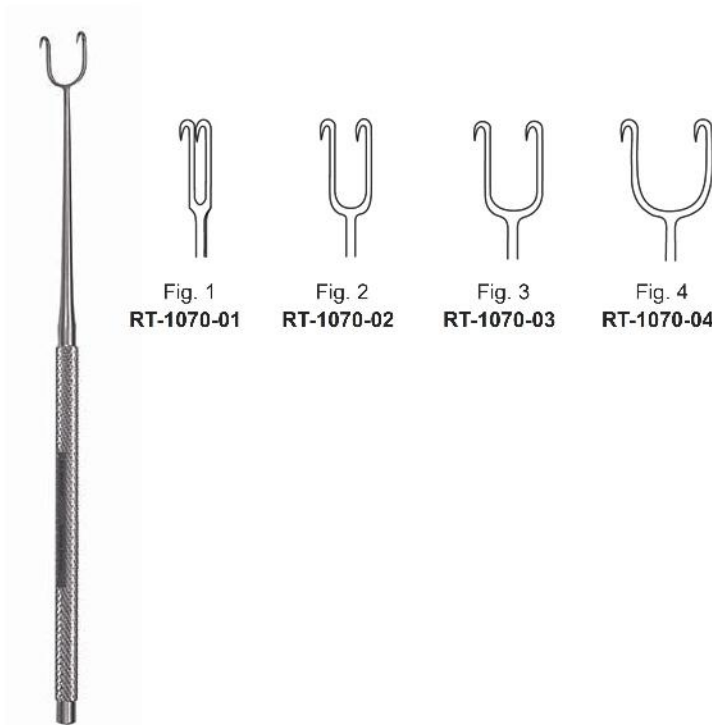

Fig. 1 RT-1070-01  
Fig. 2 RT-1070-02  
Fig. 3 RT-1070-03  
Fig. 4 RT-1070-04

**JOSEPH**  
16,0 cm, 6 1/4"

Wundhaken  
Retractors  
Separadores  
Divaricatori



Fig. 1  
RT-1082-01

scharf  
sharp  
agudos  
acuti

**KNAPP**  
13,0 cm, 5"



Fig. 2  
RT-1082-02

stumpf  
blunt  
romo  
smusso



16,0 cm, 6 1/4"



RT-1088-02



RT-1089-02



RT-1088-03

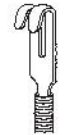

RT-1089-03



RT-1088-04



RT-1089-04



RT-1088-04

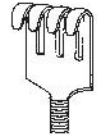

v-1089-04

fl exibel · fl exible · fl exibles · fl essibili



16,0 cm, 6 1/4"



RT-1101-01



RT-1103-01



RT-1102-01



RT-1101-02



RT-1103-02



RT-1102-02



RT-1101-03



RT-1103-03



RT-1102-03



RT-1101-04



RT-1103-04



RT-1102-04

scharf  
sharp  
agudos  
acuti

halbscharf  
semi-sharp  
semi-agudos  
semi-acuti

stumpf  
blunt  
romo  
smusso

Wundhaken  
Retractors  
Separadores  
Divaricatori



16,0 cm, 6 1/4"



RT-1111-01



RT-1111-02



RT-1111-03



RT-1111-04

scharf  
sharp  
agudos  
acuti

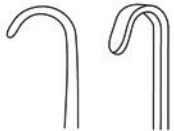

RT-1112-01



RT-1112-02



RT-1112-03

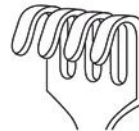

RT-1112-04

stumpf  
blunt  
romo  
smusso



**CUSHING**  
19,0 cm, 7 1/2"



Fig. 1  
RT-1140-01



Fig. 2  
RT-1140-02



**LANGENBECK-GREEN**  
16,0 cm, 6 1/4"



16 x 6 mm  
RT-1162-01



24 x 6 mm  
RT-1162-02

Wundhaken  
Retractors  
Separadores  
Divaricatori



**MEYERDING**  
18,0 cm, 7"

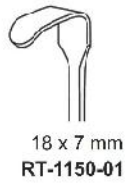

18 x 7 mm  
**RT-1150-01**

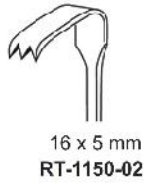

16 x 5 mm  
**RT-1150-02**



7 x 4 mm  
**RT-1150-03**



14 x 8 mm  
**RT-1166-16**

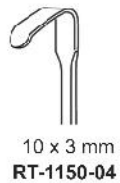

10 x 3 mm  
**RT-1150-04**

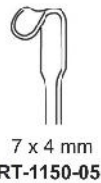

7 x 4 mm  
**RT-1150-05**

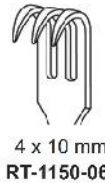

4 x 10 mm  
**RT-1150-06**



16,0 cm, 6 1/4"



**SENN-GREEN**  
15,0 cm, 6"

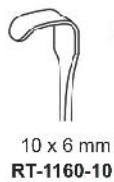

10 x 6 mm  
**RT-1160-10**



20 x 6 mm  
**RT-1160-20**



**MINI-LANGENBECK**  
16,0 cm, 6 1/4"

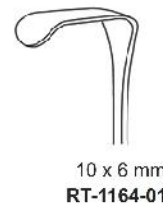

10 x 6 mm  
**RT-1164-01**



17 x 5 mm  
**RT-1164-02**



20 x 6 mm  
**RT-1164-03**

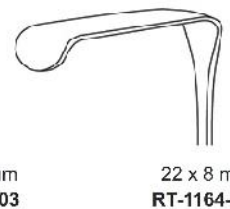

22 x 8 mm  
**RT-1164-04**

Wundhaken  
Retractors  
Separadores  
Divaricatori



**RAGNELL-DAVIS**  
14,0 cm, 5½"  
RT-1170-14



**RAGNELL**  
15,0 cm, 6"  
RT-1174-15

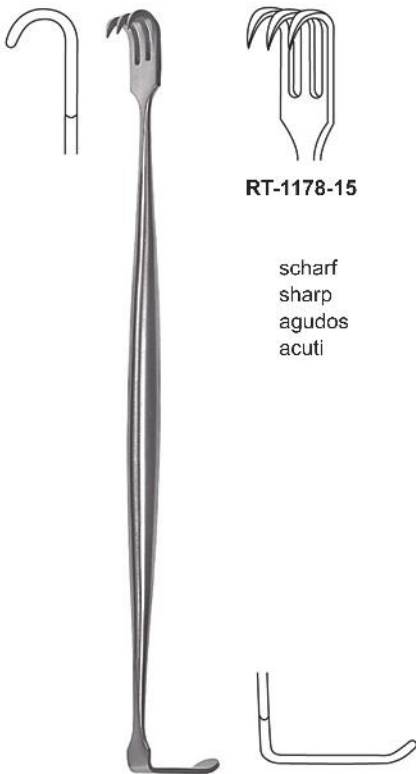

**BABY SENN-MILLER**  
15,0 cm, 6"

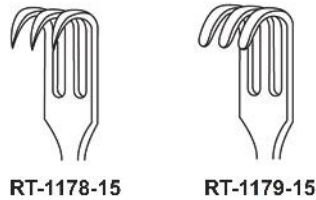

scharf  
sharp  
agudos  
acuti

stumpf  
blunt  
romo  
smusso

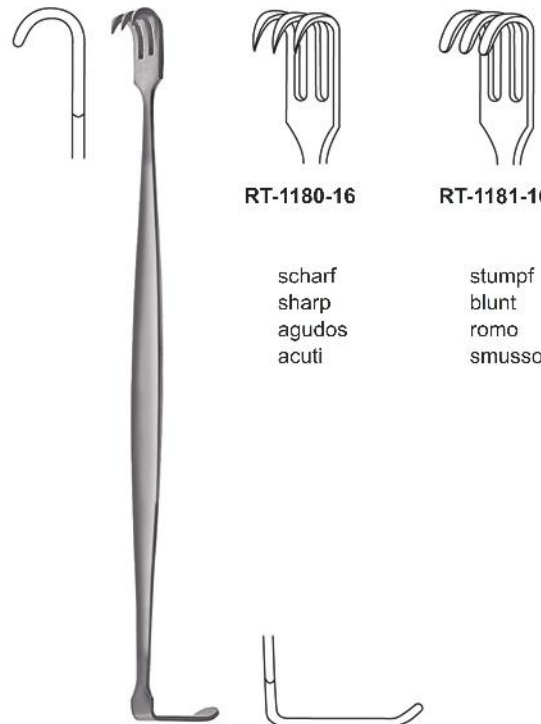

**SENN-MILLER**  
16,0 cm, 6¼"

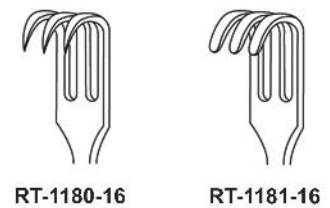

scharf  
sharp  
agudos  
acuti

stumpf  
blunt  
romo  
smusso



Wundhaken  
Retractors  
Separadores  
Divaricatori

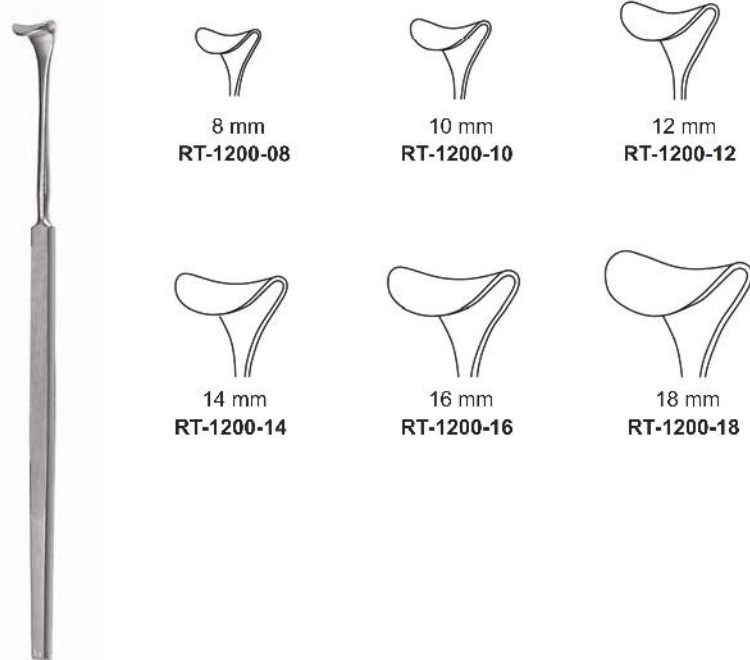

8 mm  
RT-1200-08

10 mm  
RT-1200-10

12 mm  
RT-1200-12

14 mm  
RT-1200-14

16 mm  
RT-1200-16

18 mm  
RT-1200-18

**DESMARRES**  
13,0 cm, 5"

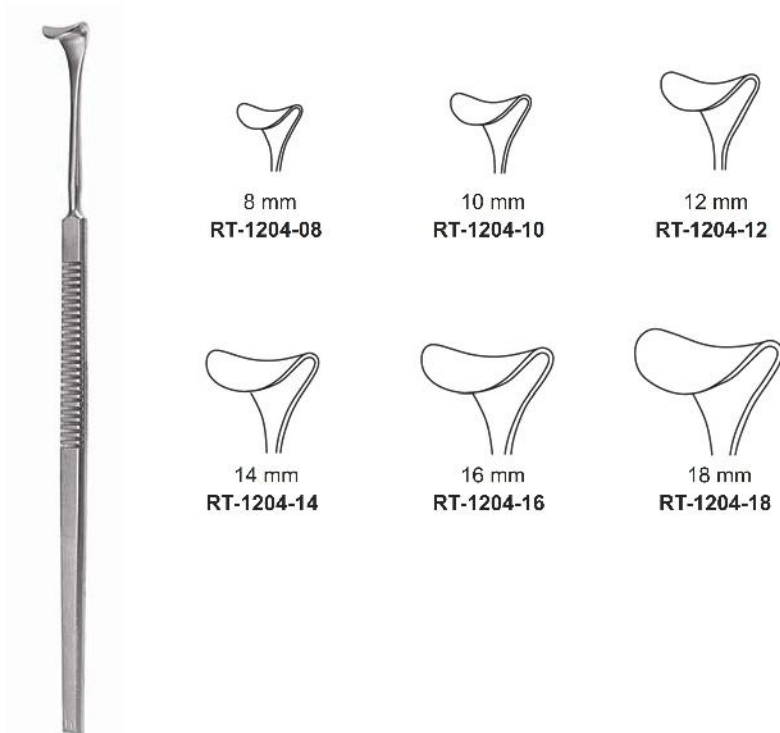

8 mm  
RT-1204-08

10 mm  
RT-1204-10

12 mm  
RT-1204-12

14 mm  
RT-1204-14

16 mm  
RT-1204-16

18 mm  
RT-1204-18

**DESMARRES**  
16,0 cm, 6 1/4"

Wundhaken  
Retractors  
Separadores  
Divaricatori



**CUSHING**  
20,0 cm, 8"



8 mm  
**RT-1210-08**



10 mm  
**RT-1210-10**



12 mm  
**RT-1210-12**



14 mm  
**RT-1210-14**



16 mm  
**RT-1210-16**

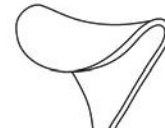

18 mm  
**RT-1210-18**



**CUSHING**  
24,0 cm, 9½"



8 mm  
**RT-1212-08**



10 mm  
**RT-1212-10**



12 mm  
**RT-1212-12**



14 mm  
**RT-1212-14**



16 mm  
**RT-1212-16**

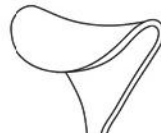

18 mm  
**RT-1212-18**

Wundhaken  
Retractors  
Separadores  
Divaricatori



8 mm  
RT-1220-08



11 mm  
RT-1220-11



13 mm  
RT-1220-13



17 mm  
RT-1220-17



20 mm  
RT-1220-20



23 mm  
RT-1220-23

**GIL-VERNET**  
24,0 cm, 9 1/2"



8 mm  
RT-1230-08



11 mm  
RT-1230-11



13 mm  
RT-1230-13



17 mm  
RT-1230-17



20 mm  
RT-1230-20



23 mm  
RT-1230-23

**GIL-VERNET**  
24,0 cm, 9 1/2"

Wundhaken  
Retractors  
Separadores  
Divaricatori



**ROUX**

Fig. 1 24 x 20 mm  
Fig. 2 29 x 26 mm  
Fig. 3 33 x 29 mm  
Fig. 4 29 x 24 mm

Satz, Fig. 1-3  
Set, fig. 1-3  
Juego, fig. 1-3  
Serie, fig. 1-3

Fig. 1 30 x 28 mm  
Fig. 2 36 x 36 mm  
Fig. 3 38 x 43 mm  
Fig. 4 45 x 28 mm

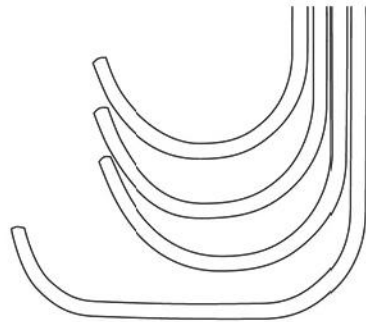
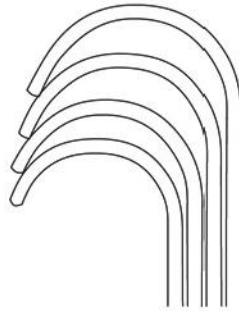

Fig. 1-3 17,0 cm, 6<sup>3</sup>/<sub>4</sub>" RT-1310-00  
Fig. 1 14,0 cm, 5<sup>1</sup>/<sub>2</sub>" RT-1310-01  
Fig. 2 15,0 cm, 6" RT-1310-02  
Fig. 3 17,0 cm, 6<sup>3</sup>/<sub>4</sub>" RT-1310-03  
Fig. 4 18,0 cm, 7" RT-1310-04



**FARABEUF**  
12,0 cm, 4<sup>3</sup>/<sub>4</sub>"  
RT-1300-12

Fig. 2 30 x 10 mm  
Fig. 1 26 x 10 mm



Fig. 1 30 x 13 mm  
Fig. 2 34 x 13 mm

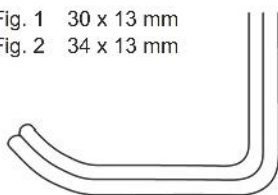

**FARABEUF**  
15,0 cm, 5<sup>3</sup>/<sub>4</sub>"  
RT-1302-15

Fig. 2 23 x 16 mm  
Fig. 1 27 x 16 mm



Fig. 1 26 x 16 mm  
Fig. 2 30 x 16 mm

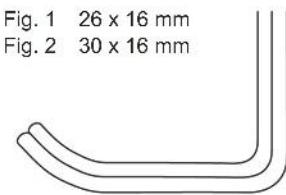

Wundhaken  
Retractors  
Separadores  
Divaricatori



**MINI-ROUX**  
14,0 cm, 5<sup>1</sup>/<sub>2</sub>"  
RT-1340-06



**BABY-ROUX**  
13,0 cm, 5"  
RT-1342-13

18 x 17 mm

24 x 21 mm

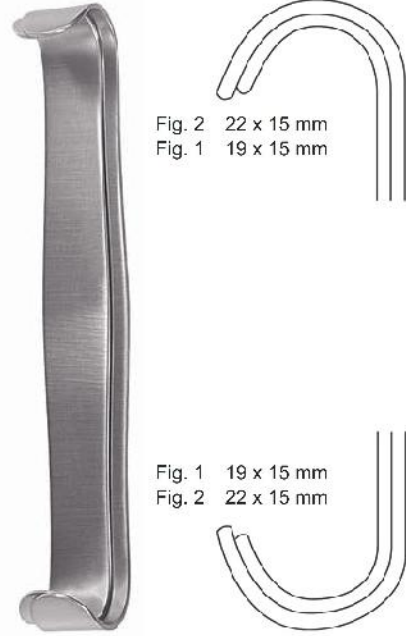

**PARKER**  
13,5 cm, 5<sup>3</sup>/<sub>8</sub>"  
RT-1350-00

Fig. 2 22 x 15 mm  
Fig. 1 19 x 15 mm

Fig. 1 19 x 15 mm  
Fig. 2 22 x 15 mm

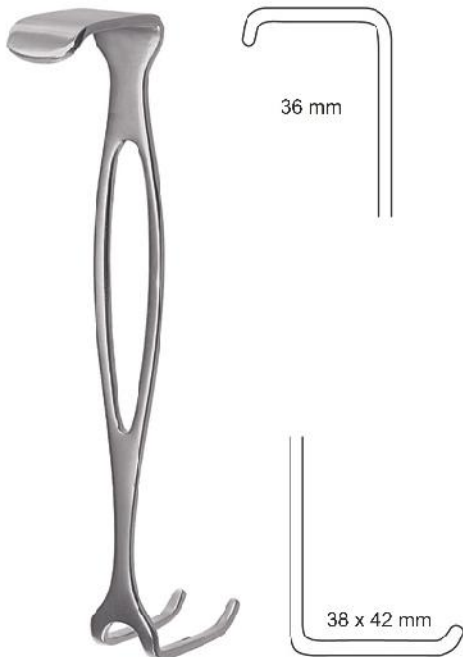

**CZERNY**  
17,5 cm, 7"  
RT-1360-00

36 mm

38 x 42 mm



**MATHIEU**  
20,0 cm, 8"  
RT-1380-00

Fig. 2 47 x 13 mm  
Fig. 1 42 x 13 mm

Fig. 1 42 x 26 mm  
Fig. 2 46 x 26 mm

Wundhaken  
Retractors  
Separadores  
Divaricatori



**GOELET**  
19,0 cm, 7½"  
RT-1396-19



**PARKER-LANGENBECK**  
21,0 cm, 8¼"  
RT-1390-00

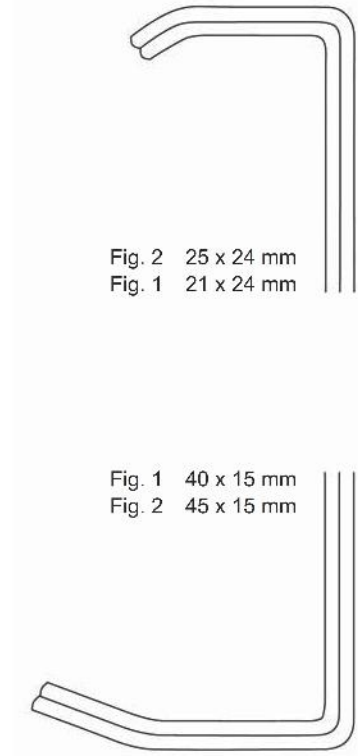

Fig. 2 25 x 24 mm  
Fig. 1 21 x 24 mm

Fig. 1 40 x 15 mm  
Fig. 2 45 x 15 mm



**CANNY RYAL**

16 mm 19,0 cm, 7½" RT-1370-16  
20 mm 19,0 cm, 7½" RT-1370-20  
25 mm 20,0 cm, 8" RT-1370-25

Wundhaken  
Retractors  
Separadores  
Divaricatori



**VOLKMANN**  
21,5 cm, 8 1/2"



RT-1001-01



9 x 8 mm  
RT-1001-02



9 x 13 mm  
RT-1001-03



9 x 19 mm  
RT-1001-04



9 x 29 mm  
RT-1001-06

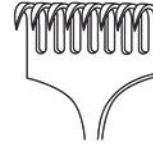

9 x 40 mm  
RT-001-08

scharf  
sharp  
agudos  
acuti



**VOLKMANN**  
21,5 cm, 8 1/2"



RT-1003-01



9 x 8 mm  
RT-1003-02



9 x 13 mm  
RT-1003-03



9 x 19 mm  
RT-1003-04



9 x 29 mm  
RT-1003-06

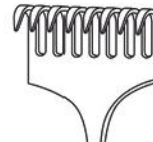

9 x 40 mm  
RT-1003-08

halbscharf  
semi-sharp  
semi-agudos  
semi-acuti

Wundhaken  
Retractors  
Separadores  
Divaricatori



**VOLKMAN**  
21,5 cm, 8½"



RT-1002-01



9 x 8 mm  
RT-1002-02



9 x 13 mm  
RT-1002-03



9 x 19 mm  
RT-1002-04



9 x 29 mm  
RT-1002-06

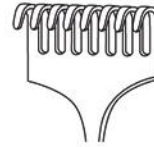

9 x 40 mm  
RT-1002-08

stumpf  
blunt  
romo  
smusso



**KOCHER**  
22,0 cm, 8⅝"



RT-1011-01



9 x 8 mm  
RT-1011-02



15 x 15 mm  
RT-1011-03



15 x 20 mm  
RT-1011-04



15 x 30 mm  
RT-1011-06



15 x 40 mm  
RT-1011-08

scharf  
sharp  
agudos  
acuti



Wundhaken  
Retractors  
Separadores  
Divaricatori



**KOCHER**  
22,0 cm, 8<sup>5</sup>/<sub>8</sub>"



RT-1013-01



9 x 8 mm  
RT-1013-02



15 x 15 mm  
RT-1013-03



15 x 20 mm  
RT-1013-04



15 x 30 mm  
RT-1013-06

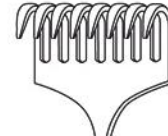

15 x 40 mm  
RT-1013-08

halbscharf  
semi-sharp  
semi-agudos  
semi-acuti



**KOCHER**  
22,0 cm, 8<sup>5</sup>/<sub>8</sub>"



RT-1012-01



9 x 8 mm  
RT-1012-02



15 x 15 mm  
RT-1012-03



15 x 20 mm  
RT-1012-04

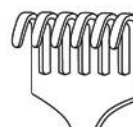

15 x 30 mm  
RT-1012-06

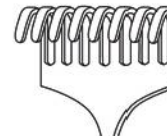

15 x 40 mm  
RT-1012-08

stumpf  
blunt  
romo  
smusso

Wundhaken  
Retractors  
Separadores  
Divaricatori



26 x 40 mm  
RT-1021-24

stumpf  
blunt  
romo  
smusso

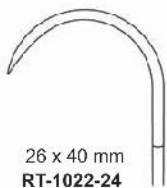

26 x 40 mm  
RT-1022-24

scharf  
sharp  
agudos  
acuti

**KOERTE**  
24,0 cm, 9<sup>1</sup>/<sub>2</sub>"



55 x 20 mm  
RT-1100-55

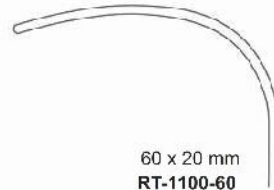

60 x 20 mm  
RT-1100-60

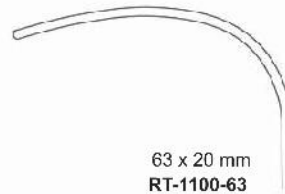

63 x 20 mm  
RT-1100-63

**LANGENBECK**  
21,0 cm, 8<sup>1</sup>/<sub>4</sub>"



40 x 40 mm  
RT-1032-04

4 Tähne  
4 teeth  
4 dientes  
4 denti

45 x 50 mm  
RT-1032-05

5 Tähne  
5 teeth  
5 dientes  
5 denti

50 x 60 mm  
RT-1032-06

6 Tähne  
6 teeth  
6 dientes  
6 denti

70 x 70 mm  
RT-1032-07

6 Tähne  
6 teeth  
6 dientes  
6 denti

**ISRAEL**  
25,0 cm, 9<sup>3</sup>/<sub>4</sub>"

Wundhaken  
Retractors  
Separadores

Divaricatori



**LANGENBECK**  
22,0 cm, 8<sup>5</sup>/<sub>8</sub>"



30 x 11 mm  
RT-1110-30

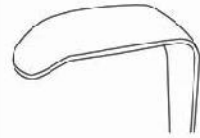

30 x 14 mm  
RT-1110-31



30 x 16 mm  
RT-1110-32



40 x 11 mm  
RT-1110-40



50 x 11 mm  
RT-1110-50



**LANGENBECK**  
22,0 cm, 8<sup>5</sup>/<sub>8</sub>"

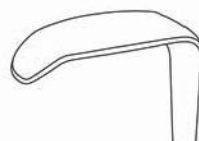

30 x 11 mm  
RT-1120-30



30 x 14 mm  
RT-1120-31

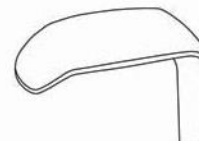

30 x 16 mm  
RT-1120-32



40 x 11 mm  
RT-1120-40

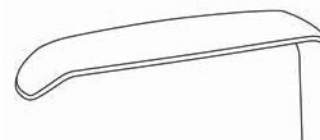

50 x 11 mm  
RT-1120-50

Wundhaken  
Retractors  
Separadores  
Divaricatori



**KOCHER-LANGENBECK**  
21,5 cm, 8½"



22 x 6 mm  
**RT-1130-22**



25 x 6 mm  
**RT-1130-25**



25 x 8 mm  
**RT-1130-26**



35 x 8 mm  
**RT-1130-35**



35 x 11 mm  
**RT-1130-36**



35 x 15 mm  
**RT-1130-37**



40 x 11 mm  
**RT-1130-40**



70 x 15 mm  
**RT-1130-70**

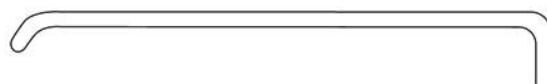

80 x 12 mm  
**RT-1130-80**

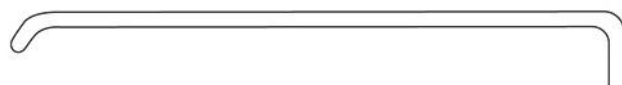

80 x 15 mm  
**RT-1130-85**



22 x 6 mm  
**RT-1130-22**

Wundhaken  
Retractors  
Separadores  
Divaricatori



**KOCHER**  
23,0 cm, 9"



40 x 18 mm  
RT-1140-18



60 x 20 mm  
RT-1140-20



60 x 25 mm  
RT-1140-25



75 x 30 mm  
RT-1140-30



75 x 40 mm  
RT-1140-40



**SAUERBRUCH**  
22,5 cm, 8<sup>3</sup>/<sub>4</sub>"



44 x 16 mm  
RT-1150-44



55 x 22 mm  
RT-1150-55



72 x 19 mm  
RT-1150-72

Wundhaken  
Retractors  
Separadores  
Divaricatori



MI



21,5 cm, 8<sup>1</sup>/<sub>2</sub>"  
14 x 17 mm  
**RT-1180-01**



22,0 cm, 8<sup>5</sup>/<sub>8</sub>"  
20 x 22 mm  
**RT-1180-02**

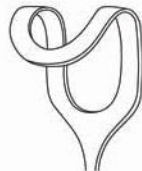

23,5 cm, 9<sup>1</sup>/<sub>4</sub>"  
26 x 30 mm  
**RT-1180-03**



MID



21,5 cm, 8<sup>1</sup>/<sub>2</sub>"  
14 x 17 mm  
**RT-1182-01**



22,0 cm, 8<sup>5</sup>/<sub>8</sub>"  
20 x 22 mm  
**RT-1182-02**



23,5 cm, 9<sup>1</sup>/<sub>4</sub>"  
26 x 30 mm  
**RT-1182-03**



**RICHARDSON (KELLY)**  
24,0 cm, 9<sup>1</sup>/<sub>2</sub>"



**RT-1012-01**



9 x 8 mm  
**RT-1012-02**

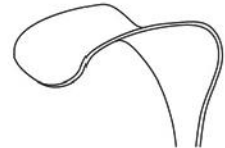

15 x 15 mm  
**RT-1012-03**

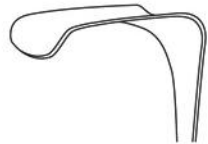

15 x 20 mm  
**RT-1012-04**

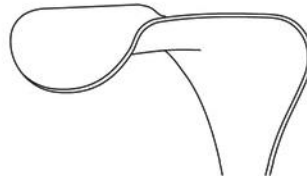

15 x 30 mm  
**RT-1012-06**

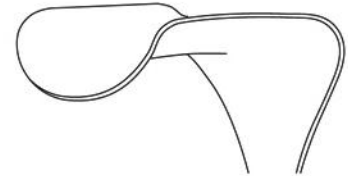

15 x 40 mm  
**RT-1012-08**

**Wundhaken  
Retractors  
Separadores  
Divaricatori**

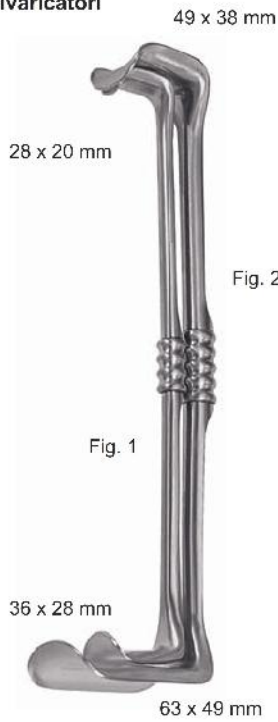
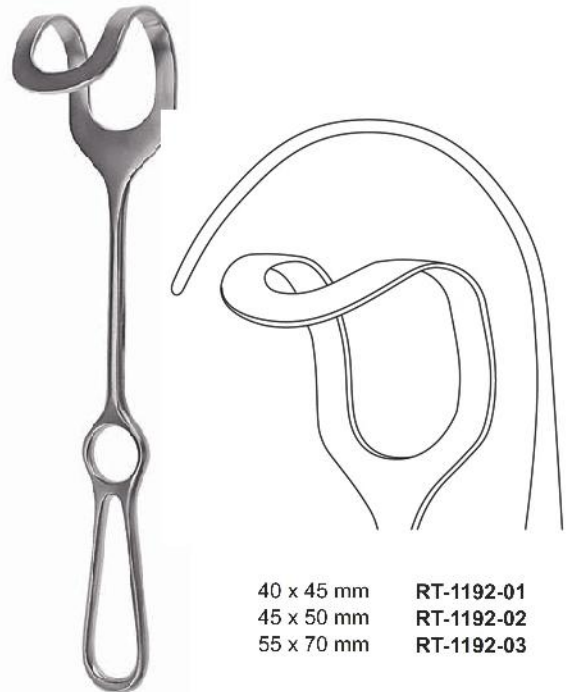

Fig. 1+2 28,0 cm, 11" RT-1200-00  
Fig. 1 26,0 cm, 10<sup>1</sup>/<sub>4</sub>" RT-1200-01  
Fig. 2 28,0 cm, 11" RT-1200-02

**RICHARDSON-EASTMAN**



**MIDDELDORPF**  
25,5 cm, 10"



**FRITSCH**  
24,0 cm, 9<sup>1</sup>/<sub>2</sub>"



**DOYEN**  
25,0 cm, 10"  
029-230-501

Wundhaken  
Retractors  
Separadores  
Divaricatori



**DOYEN-STILLE**  
22,0 cm, 8<sup>5</sup>/<sub>16</sub>"

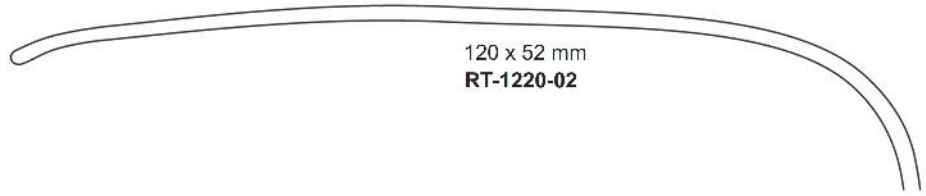

120 x 52 mm  
**RT-1220-02**

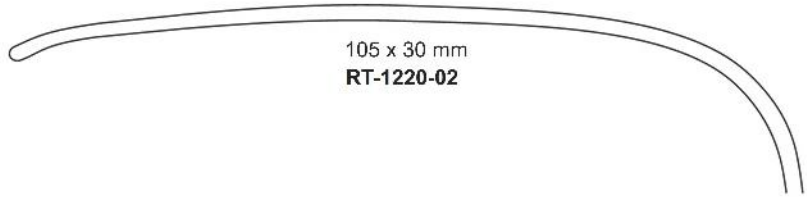

105 x 30 mm  
**RT-1220-02**

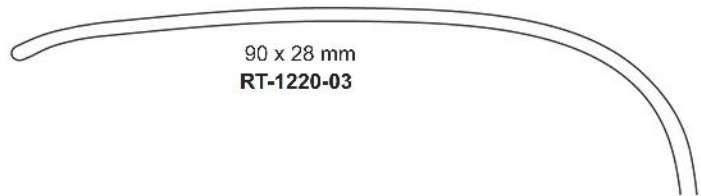

90 x 28 mm  
**RT-1220-03**

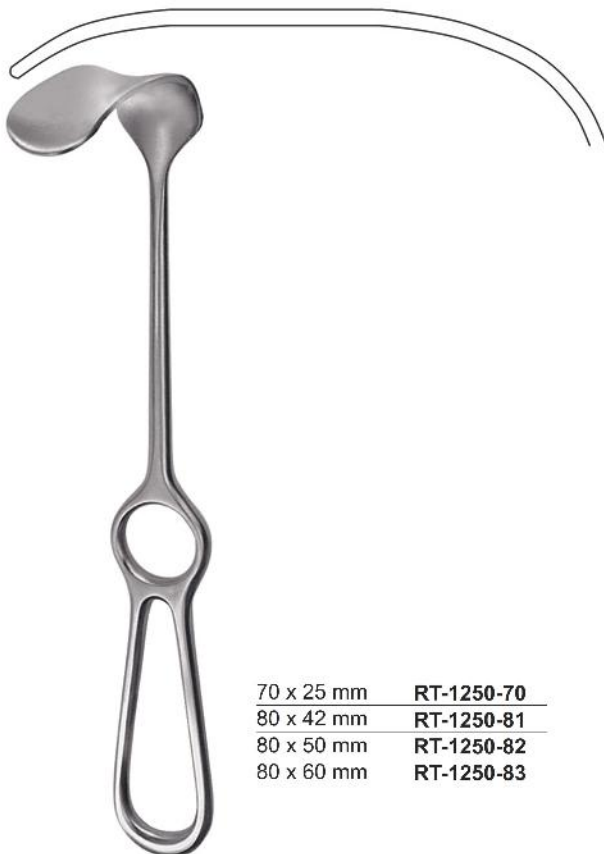

**KOCHER**  
25,0 cm, 10"

70 x 25 mm	<b>RT-1250-70</b>
80 x 42 mm	<b>RT-1250-81</b>
80 x 50 mm	<b>RT-1250-82</b>
80 x 60 mm	<b>RT-1250-83</b>



**LAHEY**  
19,0 cm, 7<sup>1</sup>/<sub>2</sub>"  
**RT-1160-19**

28 x 6 mm



Wundhaken  
Retractors  
Separadores  
Divaricatori



12 x 14 mm

**LITTLE**  
20,0 cm, 8"  
RT-1164-20



115 x 22 mm **RT-1260-01**  
115 x 27 mm **RT-1260-02**

**SIMON**  
28,0 cm, 11"



160 x 38 mm **RT-1280-61**  
160 x 57 mm **RT-1280-62**  
190 x 38 mm **RT-1280-91**  
190 x 57 mm **RT-1280-92**

**KELLY**  
27,0 cm, 10 1/2"

Wundhaken  
Retractors  
Separadores  
Divaricatori



85 x 35 mm	RT-1274-01
120 x 50 mm	RT-1274-02
155 x 50 mm	RT-1274-03

**MIKULICZ**  
26,0 cm, 10<sup>1</sup>/<sub>4</sub>"



90 x 50 mm

**MIKULICZ**  
26,0 cm, 10<sup>1</sup>/<sub>4</sub>"  
RT-1272-90



70 x 38 mm	RT-1290-38
70 x 50 mm	RT-1290-51

**MORRIS**  
24,5 cm, 9<sup>5</sup>/<sub>8</sub>"

Wundhaken  
Retractors  
Separadores  
Divaricatori



127 x 40 mm **RT-1500-40**  
127 x 62 mm **RT-1500-62**

**HARRINGTON**  
32,0 cm, 12 1/2"



82 x 22 mm **RT-1390-01**  
108 x 43 mm **RT-1390-02**  
115 x 65 mm **RT-1390-03**

**CORYKKOS**  
24,0 cm, 9 1/2"



**ZENKER**

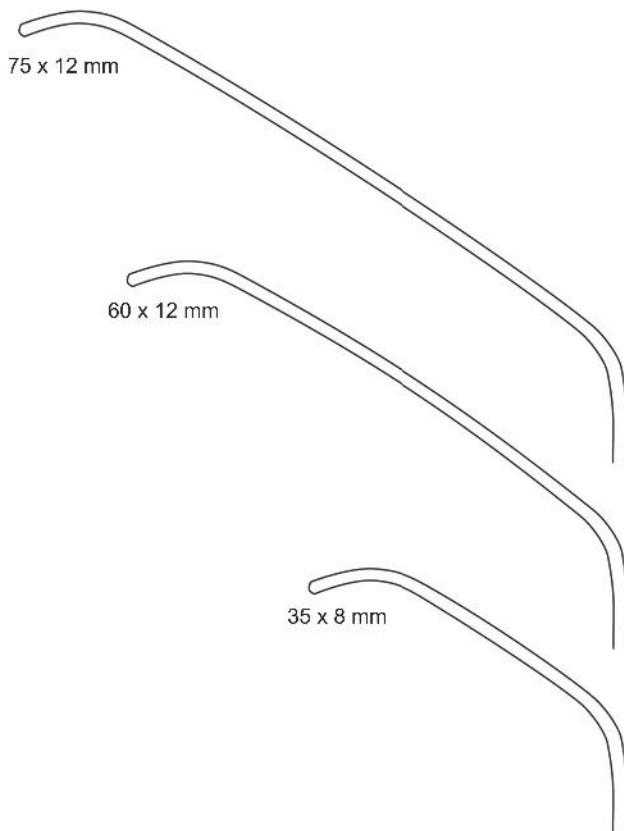

25,0 cm, 9 3/4"  
**RT-1320-25**

26,0 cm, 10 1/4"  
**RT-1320-26**

27,5 cm, 10 3/4"  
**RT-1320-27**

Wundhaken  
Retractors  
Separadores  
Divaricatori



**MEYERDING**  
22,5 cm, 8<sup>3</sup>/<sub>4</sub>"

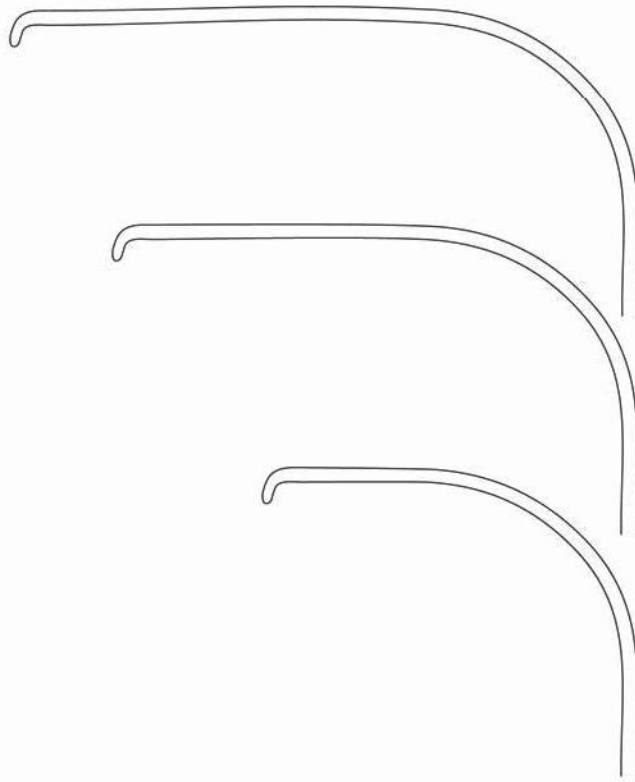

90 x 50 mm  
**RT-1350-50**

75 x 25 mm  
**RT-1350-25**

50 x 16 mm  
**RT-1350-16**



**BRUNNER**  
25,0 cm, 10"

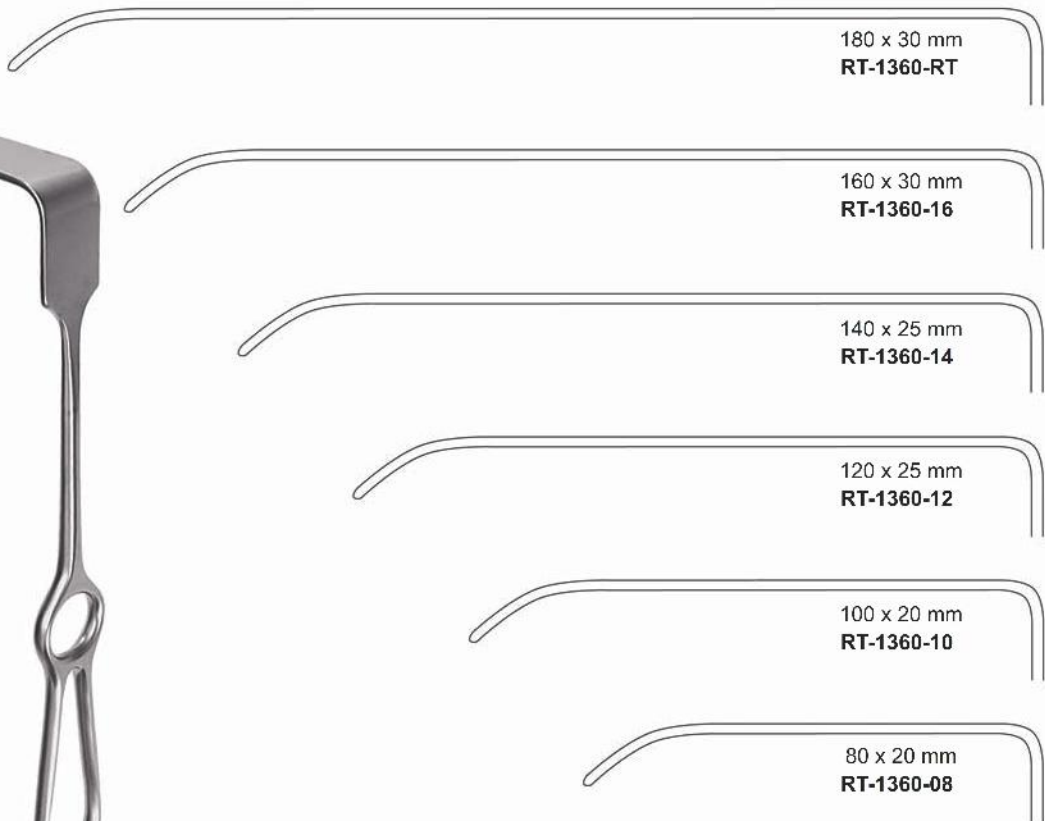

180 x 30 mm  
**RT-1360-RT**

160 x 30 mm  
**RT-1360-16**

140 x 25 mm  
**RT-1360-14**

120 x 25 mm  
**RT-1360-12**

100 x 20 mm  
**RT-1360-10**

80 x 20 mm  
**RT-1360-08**

Wundhaken  
Retractors  
Separadores  
Divaricatori

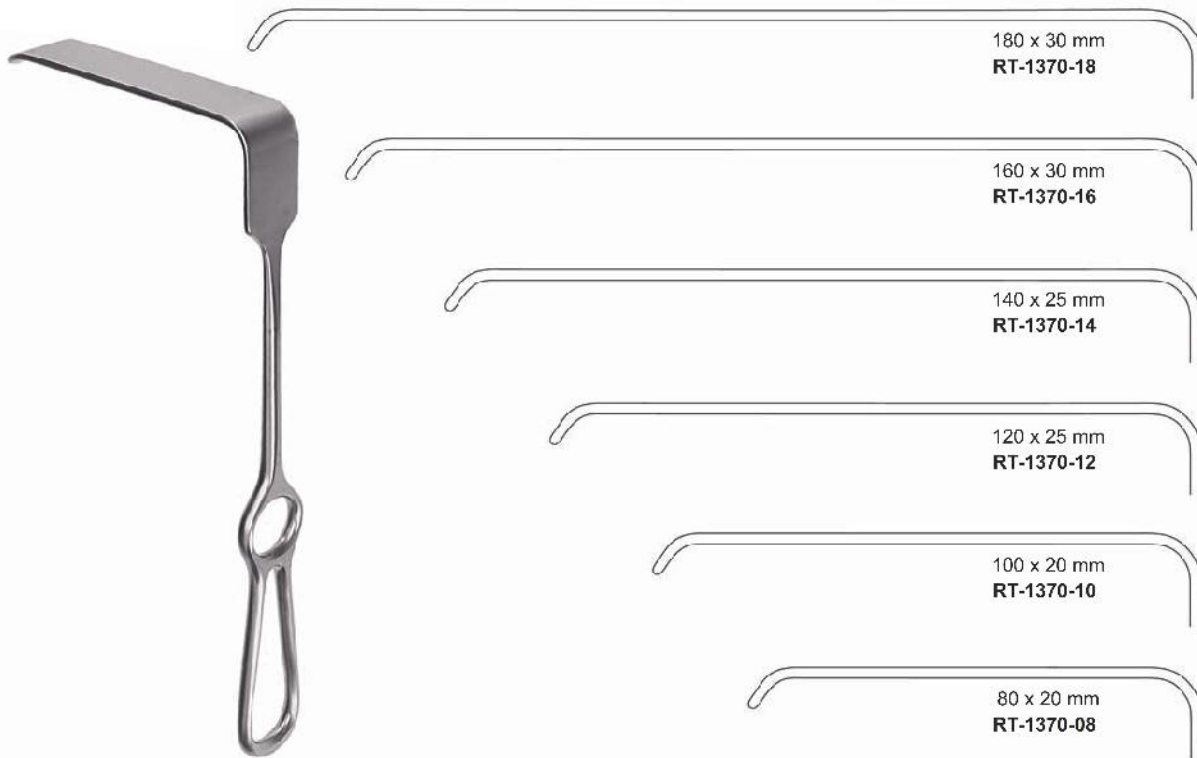

**BRUNNER**  
25,0 cm, 10"



**DEAVER**  
18,0 cm, 7"  
RT-1602-18



**DEAVER**  
21,5 cm, 8½"  
RT-1602-22



**DEAVER**  
23,0 cm, 9"  
RT-1602-23

Wundhaken  
Retractors  
Separadores  
Divaricatori



**DEAVER**  
30,0 cm, 11<sup>3</sup>/<sub>4</sub>"  
RT-1604-30



**DEAVER**  
33,0 cm, 13"  
RT-1604-33



**DEAVER**  
36,0 cm, 14<sup>1</sup>/<sub>8</sub>"  
RT-1604-36



**DEAVER**  
30,0 cm, 11<sup>3</sup>/<sub>4</sub>"  
RT-1610-38



**DEAVER**  
30,0 cm, 11<sup>3</sup>/<sub>4</sub>"  
RT-1610-50



**DEAVER**  
30,0 cm, 11<sup>3</sup>/<sub>4</sub>"  
RT-1610-75

Wundhaken  
Retractors  
Separadores  
Divaricatori

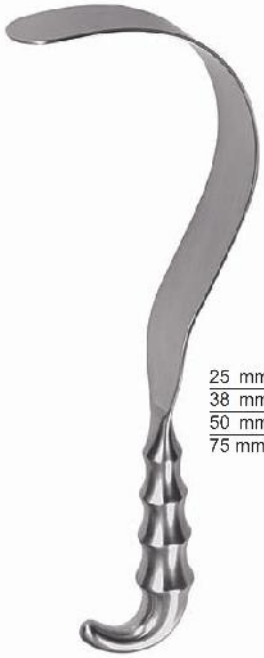

25 mm	RT-1600-25
38 mm	RT-1600-38
50 mm	RT-1600-50
75 mm	RT-1600-75

**DEAVER GRIP**  
30,0 cm, 11½"



40 mm	30,0 cm, 11¾"	RT-1700-30
54 mm	32,0 cm, 12½"	RT-1700-32

**ALLISON**



75 x 50 mm	16,0 cm, 6¼"	RT-1710-50
75 x 90 mm	16,0 cm, 6¼"	RT-1710-90

**DAVIDSON**



**ST MARKS**

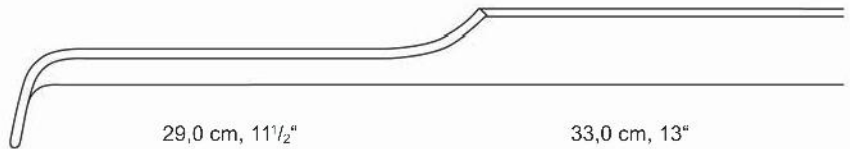

29,0 cm, 11½"  
130 x 60 mm  
RT-1720-01

33,0 cm, 13"  
180 x 60 mm  
RT-1720-02



29,0 cm, 11½"  
130 x 60 mm  
RT-1721-01

33,0 cm, 13"  
180 x 60 mm  
RT-1721-02



**Wundspreizer**  
**Self-Retaining Retractors**  
**Separadores con retenida automática**  
**Divaricatori autostatici**





Wundspreizer  
Self-Retaining Retractors  
Separadores con retenida automática  
Divaricatori autostatici

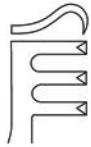

5,0 cm, 2"  
RT-1610-05

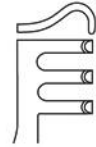

5,0 cm, 2"  
RT-1611-05



**FINSEN**

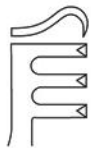

7,0 cm, 2<sup>3</sup>/<sub>4</sub>"  
RT-1610-07

scharf  
sharp  
agudos  
acuti

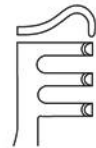

7,0 cm, 2<sup>3</sup>/<sub>4</sub>"  
RT-1611-07

stumpf  
blunt  
romo  
smusso



**JANSEN**  
10,0 cm, 4"



RT-1630-10

scharf  
sharp  
agudos  
acuti

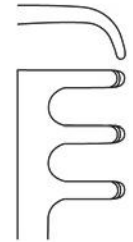

RT-1631-10

stumpf  
blunt  
romo  
smusso



**ALM**

scharf  
sharp  
agudos  
acuti

halbscharf  
semi-sharp  
semi-agudos  
semi-acuti

stumpf  
blunt  
romo  
smusso



7,0 cm, 2<sup>3</sup>/<sub>4</sub>"  
10,0 cm, 4"

RT-1620-07  
RT-1620-10



RT-1622-07  
RT-1622-10

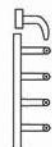

RT-1621-07  
RT-1621-10



**ALLPORT**  
9,5 cm, 3<sup>3</sup>/<sub>4</sub>"  
RT-1626-09

Wundspreizer  
Self-Retaining Retractors  
Separadores con retenida automática  
Divaricatori autostatici



**SALP-CONTOUR**  
14,0 cm, 5½"



**RT-1660-14**  
scharf  
sharp  
agudos  
acuti



**RT-1661-14**  
stumpf  
blunt  
romo  
smusso



**ADSON-BABY**  
16,0 cm, 6¼"



**RT-1684-16**  
scharf  
sharp  
agudos  
acuti



**RT-1685-16**  
stumpf  
blunt  
romo  
smusso



**ANDERSON-ADSON**  
20,0 cm, 8"



**RT-1660-14**  
scharf  
sharp  
agudos  
acuti



**RT-1661-14**  
stumpf  
blunt  
romo  
smusso



**ADSON**  
26,5 cm, 10½"



**RT-1684-16**  
scharf  
sharp  
agudos  
acuti



**RT-1685-16**  
stumpf  
blunt  
romo  
smusso

Wundspreizer  
 Self-Retaining Retractors  
 Separadores con retenida automática  
 Divaricatori autostatici



**MOLLISON**  
 15,5 cm, 6"  
 RT-1674-15



scharf  
 sharp  
 agudos  
 acuti



**SCHUHKNECHT**  
 12,5 cm, 5"



**RT-1660-14**  
 scharf  
 sharp  
 agudos  
 acuti



**RT-1661-14**  
 stumpf  
 blunt  
 romo  
 smusso



**WULLSTEIN**



scharf  
 sharp  
 agudos  
 acuti

stumpf  
 blunt  
 romo  
 smusso

10,5 cm, 4 <sup>1</sup> / <sub>8</sub> "	RT-1810-10	RT -1811-10
13,0 cm, 5"	RT-1810-13	RT-1811-13
15,0 cm, 6"	RT-1810-15	RT-1811-15
18,0 cm, 7"	RT-1810-18	RT-1811-18



**MAYO-ADAMS**  
 16,5 cm, 6<sup>1</sup>/<sub>2</sub>"  
 RT-1822-17

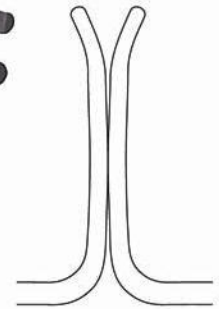

Wundspreizer  
Self-Retaining Retractors  
Separadores con retenida automática  
Divaricatori autostatici



**WEITLANER-LOKTITE**  
10,5 cm, 4 1/8"



**RT-1650-10**

scharf  
sharp  
agudos  
acuti



**RT-1651-10**

stumpf  
blunt  
romo  
smusso



**WEITLANER**  
13,0 cm, 5"



**RT-1670-13**

scharf  
sharp  
agudos  
acuti



**RT-1671-13**

stumpf  
blunt  
romo  
smusso



**WEITLANER**  
16,5 cm, 6 1/2"



**RT-1670-16**

scharf  
sharp  
agudos  
acuti



**RT-1671-16**

stumpf  
blunt  
romo  
smusso



**WEITLANER**  
20,0 cm, 8"



**RT-1670-20**

scharf  
sharp  
agudos  
acuti



**RT-1671-20**

stumpf  
blunt  
romo  
smusso

Wundspreizer  
Self-Retaining Retractors  
Separadores con retenida automática  
Divaricatori autostatici



**WEITLANER**  
24,0 cm, 9 1/2"



**RT-1670-20**

scharf  
sharp  
agudos  
acuti



**RT-1671-20**

stumpf  
blunt  
romo  
smusso



**PLESTER**  
13,0 cm, 5"



**RT-1830-13**

scharf  
sharp  
agudos  
acuti



**RT-1831-13**

stumpf  
blunt  
romo  
smusso



**MILLIGAN**  
13,0 cm, 5"  
**RT-1840-13**

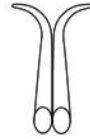
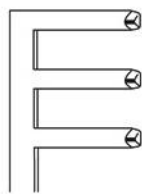
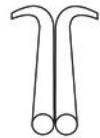

**PLESTER**  
11,0 cm, 4 3/8"  
**RT-1672-11**

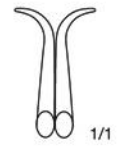

**PLESTER**  
11,0 cm, 4 3/8"  
**RT-1673-11**

Wundspreizer  
Self-Retaining Retractors  
Separadores con retenida automática  
Divaricatori autostatici



**WEITLANER-BABY**  
13,0 cm, 5"  
030-1850-13

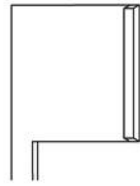

(CONE)

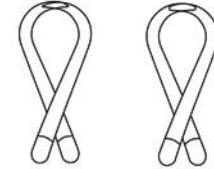

20,0 cm, 8" RT-1860-20 RT-1861-20  
26,0 cm, 10 1/4" RT-1860-26 RT-1861-26

scharf	stumpf
sharp	blunt
agudos	romo
acuti	smusso



**GELPI**  
13,5 cm, 5 3/8"  
RT-1202-14

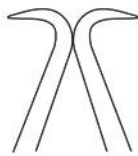

**GELPI**  
19,0 cm, 7 1/2"  
RT-1202-19



**GELPI-LOKTITE**  
19,0 cm, 7 1/2"  
RT-1250-19

Wundspreizer  
 Self-Retaining Retractors  
 Separadores con retenida automática  
 Divaricatori autostatici



**BECKMANN-ADSON**  
 31,0 cm, 12 1/4"

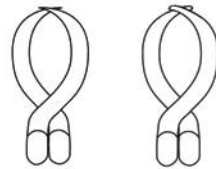

25 x 25 mm	<b>RT-1870-01</b>	<b>RT-1871-01</b>
25 x 31 mm	<b>RT-1870-02</b>	<b>RT-1871-02</b>
25 x 40 mm	<b>RT-1870-03</b>	<b>RT-1871-03</b>
25 x 45 mm	<b>RT-1870-04</b>	<b>RT-1871-04</b>

scharf	stumpf
sharp	blunt
agudos	romo
acuti	smusso

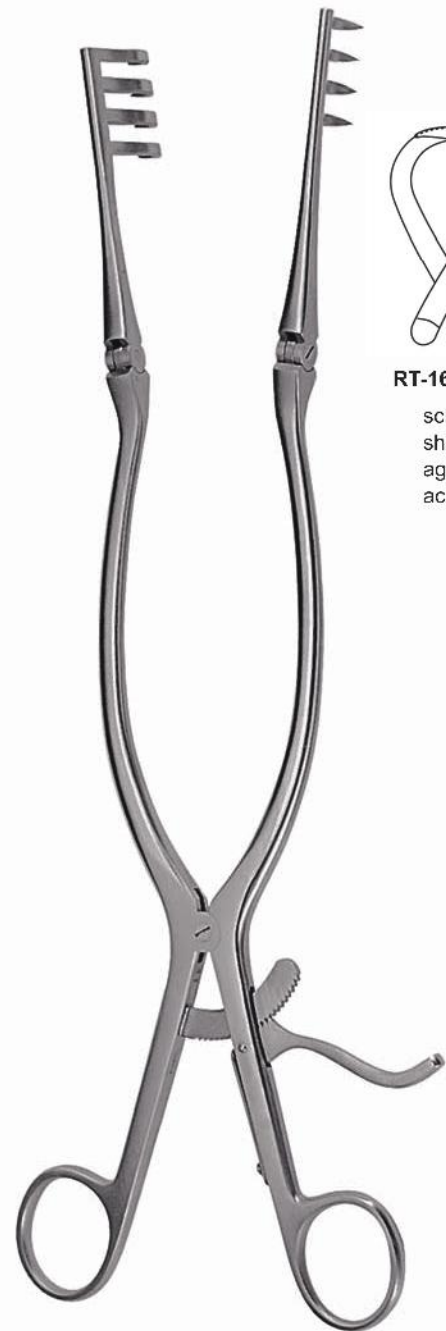

**BECKMANN**  
 31,0 cm, 12 1/4"



**RT-1690-31**  
 scharf  
 sharp  
 agudos  
 acuti

Wundspreizer  
Self-Retaining Retractors  
Separadores con retenida automática  
Divaricatori autostatici



ADSON  
32,0 cm, 12 1/2"



030-1691-32

stumpf  
blunt  
romo  
smusso



DE BAKEY

10,0 cm, 4" RT-1240-10  
14,0 cm, 5 1/2" RT-1240-14



Wundspreizer  
 Self-Retaining Retractors  
 Separadores con retenida automática  
 Divaricatori autostatici



**NORFOLK AND NORWICH**  
 22,0 cm, 8<sup>5</sup>/<sub>8</sub>"  
 RT-1401-22



stumpf  
 blunt  
 romo  
 smusso



**JACKSON BURROWS**  
 17,5 cm, 7"  
 RT-1411-17

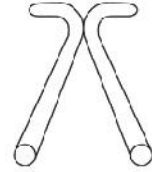

stumpf  
 blunt  
 romo  
 smusso



**RICHTER**  
 17,0 cm, 6<sup>3</sup>/<sub>4</sub>"  
 RT-1420-17



**JOLL (FRIEDMAN)**  
 15,5 cm, 6"  
 RT-1430-15

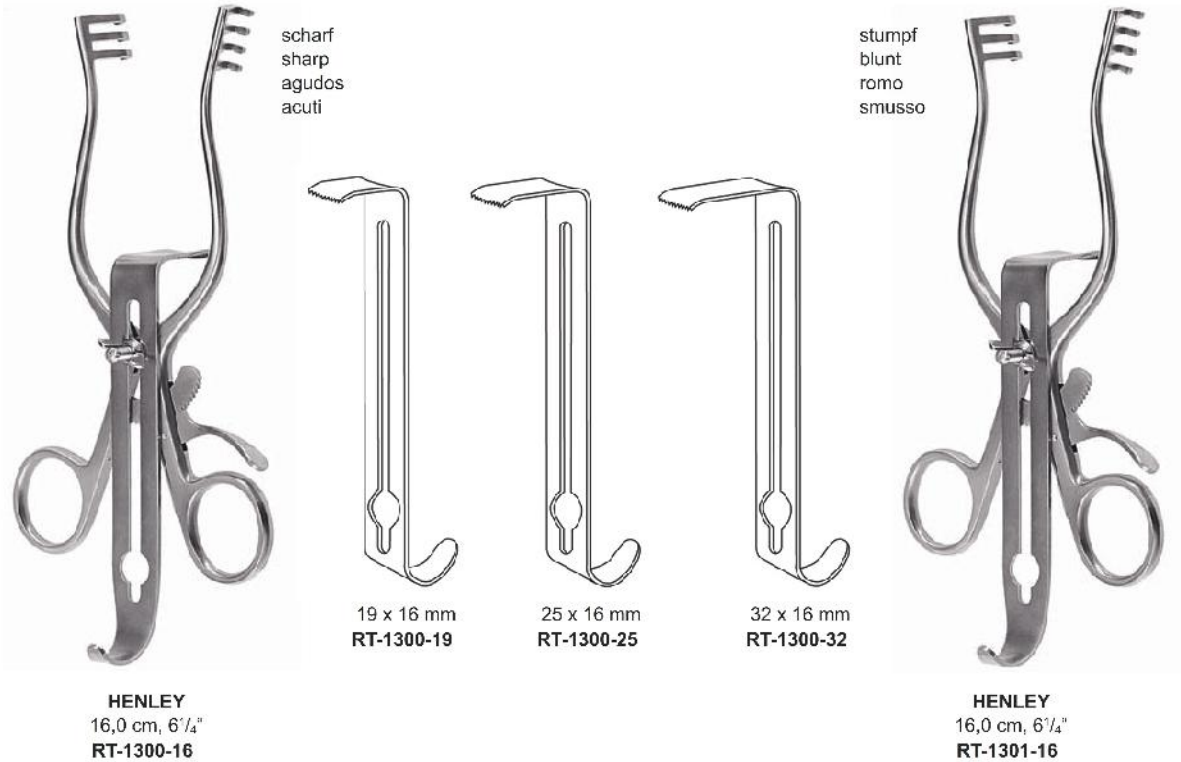

**HENLEY**  
RT-1300-00

komplett, bestehend aus:

- 1 Sperrer mit Seitenvalven, scharf (070-300-16)
- 1 Mittelvalve 19 x 16 mm (070-300-19)
- 1 Mittelvalve 25 x 16 mm (070-300-25)
- 1 Mittelvalve 32 x 16 mm (070-300-32)

complete, consisting of:

- 1 Spreader with lateral valves, sharp (070-300-16)
- 1 Central valve 19 x 16 mm (070-300-19)
- 1 Central valve 25 x 16 mm (070-300-25)
- 1 Central valve 32 x 16 mm (070-300-32)

completo, compuesto of:

- 1 Separadorcon valvas laterales, agudas (070-300-16)
- 1 Valva central 19 x 16 mm (070-300-19)
- 1 Valva central 25 x 16 mm (070-300-25)
- 1 Valva central 32 x 16 mm (070-300-32)

completo, composto da:

- 1 Divaricatore con valve laterali, acuto (070-300-16)
- 1 Valva centrale 19 x 16 mm (070-300-19)
- 1 Valva centrale 25 x 16 mm (070-300-25)
- 1 Valva centrale 32 x 16 mm (070-300-32)

**HENLEY**  
RT-1301-00

komplett, bestehend aus:

- 1 Sperrer mit Seitenvalven, stumpf (070-301-16)
- 1 Mittelvalve 19 x 16 mm (070-300-19)
- 1 Mittelvalve 25 x 16 mm (070-300-25)
- 1 Mittelvalve 32 x 16 mm (070-300-32)

complete, consisting of:

- 1 Spreader with lateral valves, blunt (070-301-16)
- 1 Central valve 19 x 16 mm (070-300-19)
- 1 Central valve 25 x 16 mm (070-300-25)
- 1 Central valve 32 x 16 mm (070-300-32)

completo, compuesto of:

- 1 Separadorcon valvas laterales, romas (070-301-16)
- 1 Valva central 19 x 16 mm (070-300-19)
- 1 Valva central 25 x 16 mm (070-300-25)
- 1 Valva central 32 x 16 mm (070-300-32)

completo, composto da:

- 1 Divaricatore con valve laterali, smusso (070-301-16)
- 1 Valva centrale 19 x 16 mm (070-300-19)
- 1 Valva centrale 25 x 16 mm (070-300-25)
- 1 Valva centrale 32 x 16 mm (070-300-32)

Wundspreizer, Bauchdeckenhalter  
 Self-Retaining Retractors, Abdominal Retractors  
 Separadores con retenida automática, Separadores abdominales  
 Divaricatori autostatici, Divaricatori addominali



**MAYO-ADAMS**  
 17,0 cm, 6 3/4"  
 RT-1320-17



**COLLIN-BABY**  
 18,0 cm, 7"  
 RT-1330-18



23 x 44 mm  
 RT-1330-23

Wechselvalven  
 Exchangeable blades  
 Valvas intergambiabiles  
 Valve intercambiabili



**RICARD**  
 28,0 cm, 11"  
 RT-1310-28



**RICARD**  
 30,0 cm, 12"  
 RT-1312-30

Wundspreizer, Bauchdeckenhalter  
Self-Retaining Retractors, Abdominal Retractors  
Separadores con retenida automática, Separadores abdominales  
Divaricatori autostatici, Divaricatori addominali



**COLLIN**  
23,5 cm, 9 1/4"  
RT-1330-24



**COLLIN**  
23,5 cm, 9 1/4"  
RT-1332-24



**COLLIN**  
23,5 cm, 9 1/4"  
RT-1334-24

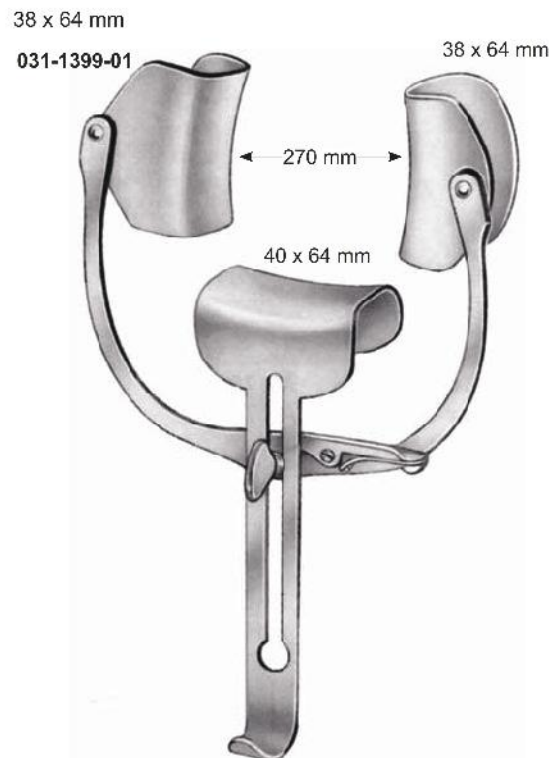

**ROBIN-MASSE**  
RT-1360-27

Wundspreizer, Bauchdeckenhalter  
 Self-Retaining Retractors, Abdominal Retractors  
 Separadores con retenida automática, Separadores abdominales  
 Divaricatori autostatici, Divaricatori addominali

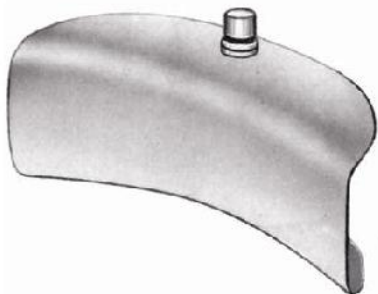

40 x 80 mm **RT-1399-02**  
 60 x 80 mm **RT-1399-03**

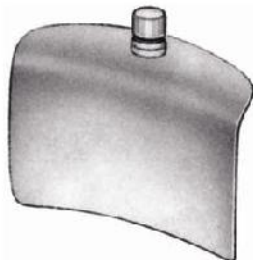

50 x 58 mm **RT-1399-10**  
 60 x 80 mm **RT-1399-13**  
 72 x 85 mm **RT-1399-14**

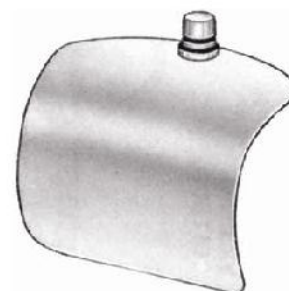

**RT-1399-23**  
 60 x 80 mm

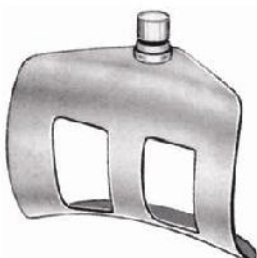

**RT-1399-33**  
 60 x 80 mm



58 x 50 mm **RT-1398-01**  
 80 x 60 mm **RT-1398-02**  
 85 x 72 mm **RT-1398-03**



62 x 38 mm **RT-1398-10**  
 80 x 38 mm **RT-1398-11**  
 100 x 38 mm **RT-1398-12**  
 80 x 38 mm **RT-1398-13**



**COLLIN**

55 x 55 mm **RT-1331-01**  
 55 x 65 mm **RT-1331-02**  
 55 x 75 mm **RT-1331-03**



**ROBIN-MASSE**

40 x 64 mm **RT-1360-01**  
 55 x 65 mm **RT-1360-02**  
 55 x 75 mm **RT-1360-03**



**RICARD**

65 x 50 mm **RT-1310-01**  
 70 x 55 mm **RT-1310-02**  
 90 x 80 mm **RT-1310-03**

Bauchdeckenhalter  
Abdominal Retractors  
Separadores abdominales  
Divaricatori addominali



**GOSSET**  
RT-1400-10



**GOSSET**  
RT-1412-14



**GOSSET**  
RT-1414-16



**ABADIE**  
RT-1450-12

Bauchdeckenhalter  
 Abdominal Retractors  
 Separadores abdominales  
 Divaricatori addominali



**BALFOUR**  
**RT-1764-18**

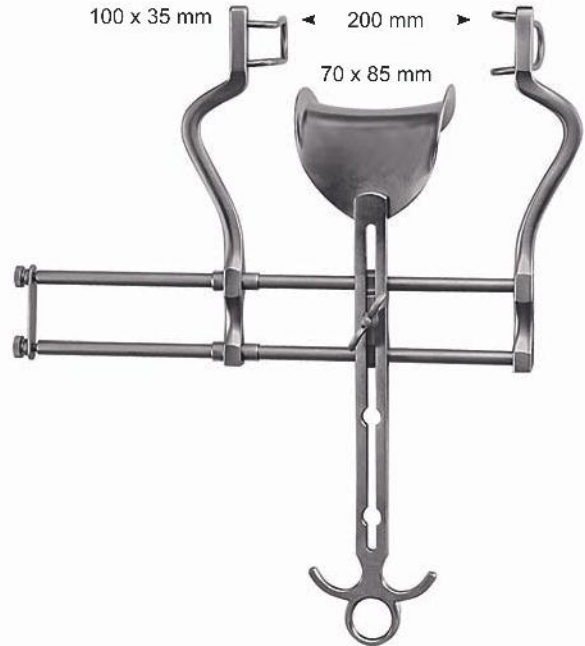

**BALFOUR**  
**RT-1768-20**

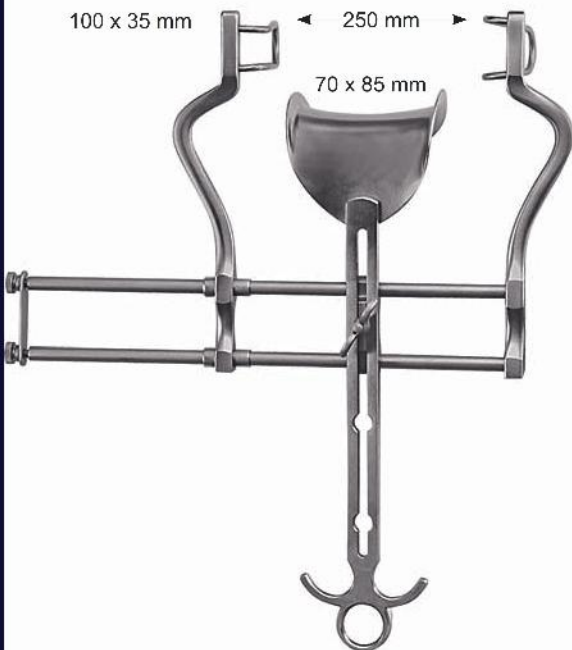

**BALFOUR**  
**RT-1768-25**

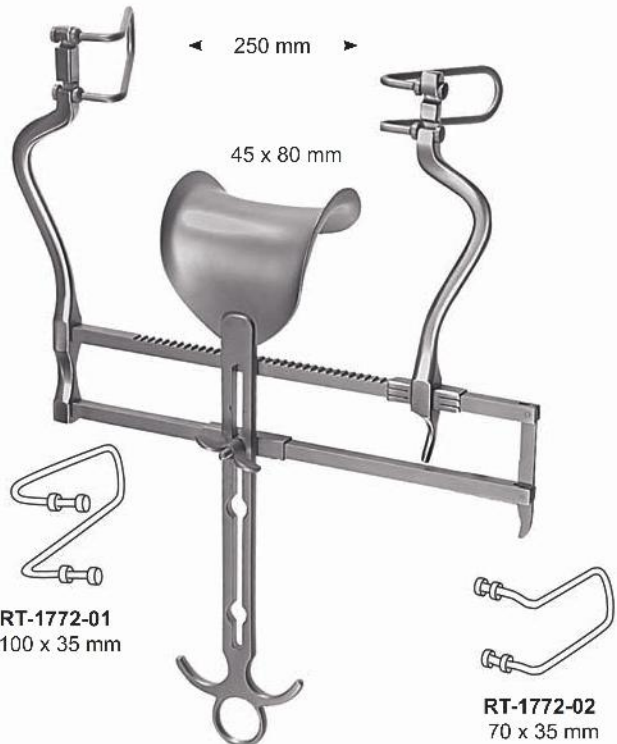

**RT-1772-01**  
 100 x 35 mm

**RT-1772-02**  
 70 x 35 mm

**BALFOUR US-TYPE**  
**RT-1772-25**

Bauchdeckenhalter  
Abdominal Retractors  
Separadores abdominales  
Divaricatori addominali

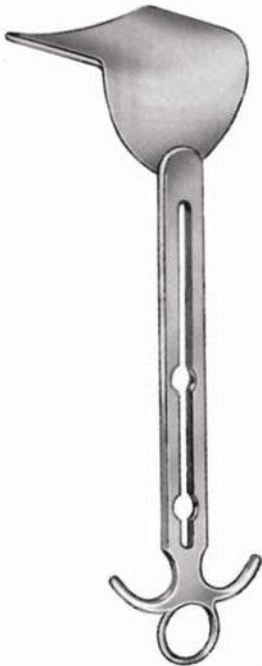

**BALFOUR**  
100 x 70 mm  
RT-1799-70

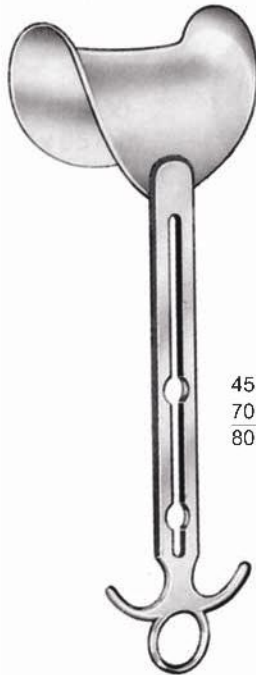

**BALFOUR**

45 x 80 mm RT-1798-01  
70 x 85 mm RT-1798-02  
80 x 90 mm RT-1798-03

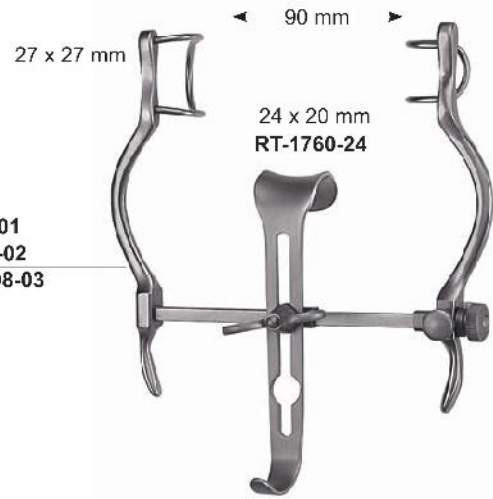

**BALFOUR**  
RT-1760-09



**BERKELEY**  
RT-1610-00

35 x 60 mm  
031-1610-01

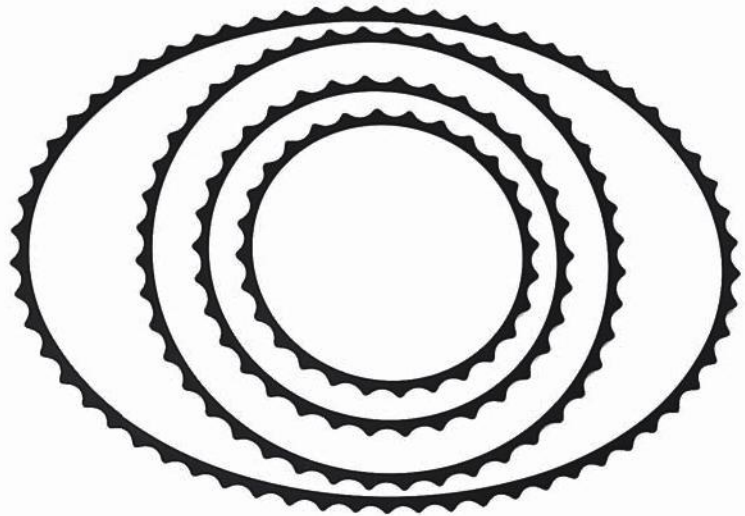

**TURNER-WARNICK**  
modifiziert

Ø 180 mm, 7" RT-1850-18  
Ø 230 mm, 9" RT-1850-23  
Ø 305 mm, 12" RT-1850-30  
455 x 330 mm RT-1850-45



Bauchdeckenhalter  
Abdominal Retractors  
Separadores abdominales  
Divaricatori addominali

geschwärzt, black fi nish, negra, nera



**RT-1859-01**  
13 mm



**RT-1859-02**  
51 x 38 mm



**RT-1859-03**  
70 x 60 mm



**RT-1859-04**  
89 x 60 mm



**RT-1859-05**  
114 x 60 mm

**TURNER-WARNICK**  
modifiziert

geschwärzt, black fi nish, negra, nera



**RT-1859-06**  
19 x 76 mm



**RT-1859-07**  
38 x 102 mm



**RT-1859-08**  
57 x 89 mm



**RT-1859-09**  
57 x 114 mm

Bauchdeckenhalter  
Abdominal Retractors  
Separadores abdominales  
Divaricatori addominali

**RT-1860-11**  
40 x 30 mm

**RT-1860-22**  
40 x 40 mm

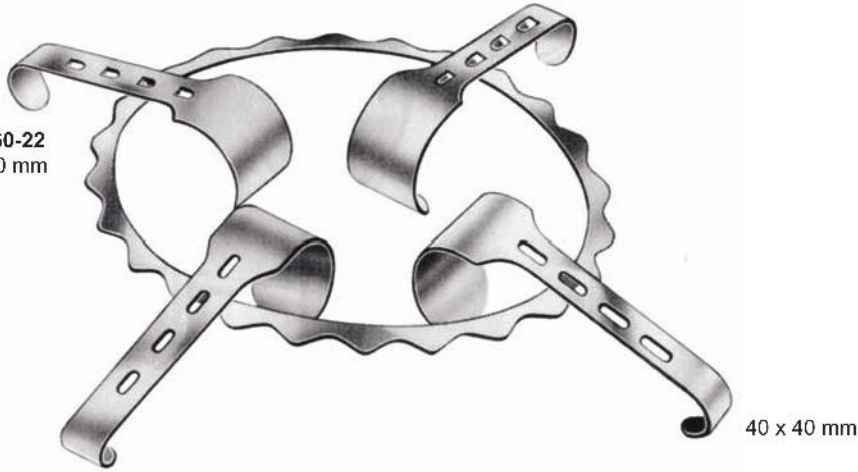

40 x 30 mm

40 x 40 mm

**RT-1860-01**  
255 x 180 mm  
Rahmen allein  
frame only  
cuadro suelto  
solo telaio

**DENNIS BROWN**  
255 x 180 mm  
**RT-1860-00**  
komplett complete  
completo  
completo

**RT-1870-11**  
80 x 45 mm



**RT-1870-12**  
110 x 70 mm



**RT-1870-01**  
Rahmen allein  
frame only  
cuadro suelto  
solo telaio

**O'SULLIVAN-O'CONNOR**  
**RT-1870-00**  
komplett  
complete  
completo  
completo

Bauchdeckenhalter  
Abdominal Retractors  
Separadores abdominales  
Divaricatori addominali

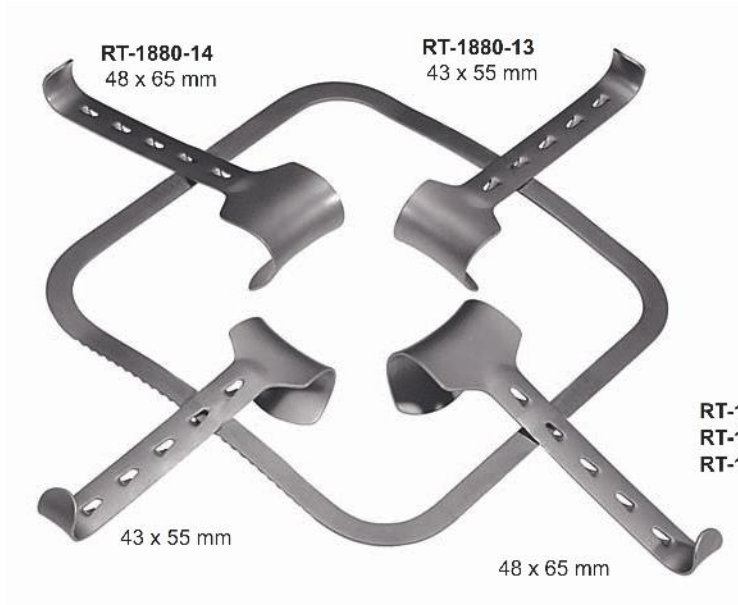

RT-1870-01 250 x 250 mm  
RT-1870-01 300 x 320 mm  
RT-1870-01 300 x 380 mm  
Rahmen allein  
frame only  
cuadro suelto  
solo telaio

**KIRSCHNER**  
**RT-1880-00**  
komplett  
complete  
completo  
completo  
1 x 074-880-01  
2 x 074-880-13  
2 x 074-880-14



**RT-1882-01**  
255 x 255 mm  
zusammenlegbarer Rahmen, allein  
folding frame, only  
cuadro plegable, suelto  
telaio pieghevole, solo

**KIRSCHNER**  
**RT-1882-00**  
komplett  
complete  
completo  
completo  
1 x 074-882-01  
2 x 074-880-13  
2 x 074-880-14



43 x 55 mm **RT-1880-13**  
48 x 65 mm **RT-1880-14**  
80 x 90 mm **RT-1880-15**  
90 x 65 mm **RT-1880-16**  
98 x 95 mm **RT-1880-17**

**KIRSCHNER**

Bauchdeckenhalter  
Abdominal Retractors  
Separadores abdominales  
Divaricatori addominali



**KIRSCHNER**  
60 x 82 mm  
RT-1880-11



**KIRSCHNER-BALFOUR**  
83 x 82 mm  
RT-1880-12



**KIRSCHNER**  
98 x 51 mm RT-1880-20  
105 x 38 mm RT-1880-21



**RT-1880-14**  
48 x 65 mm

**RT-1890-01**  
300 x 240 mm  
Rahmen allein  
frame only  
cuadro suelto  
solo telaio

**RT-1880-15**  
80 x 90 mm

**KIRSCHNER, oval**  
**RT-1884-00**  
komplett, complete, completo, completo  
1 x 074-884-01  
3 x 074-880-14  
1 x 074-880-15  
1 x 074-880-20  
1 x 074-880-21



**KIRSCHNER**  
98 x 51 mm RT-1880-20  
105 x 38 mm RT-1880-21

Bauchdeckenhalter  
Abdominal Retractors  
Separadores abdominales  
Divaricatori addominali

RT-1890-13  
76 x 98 mm

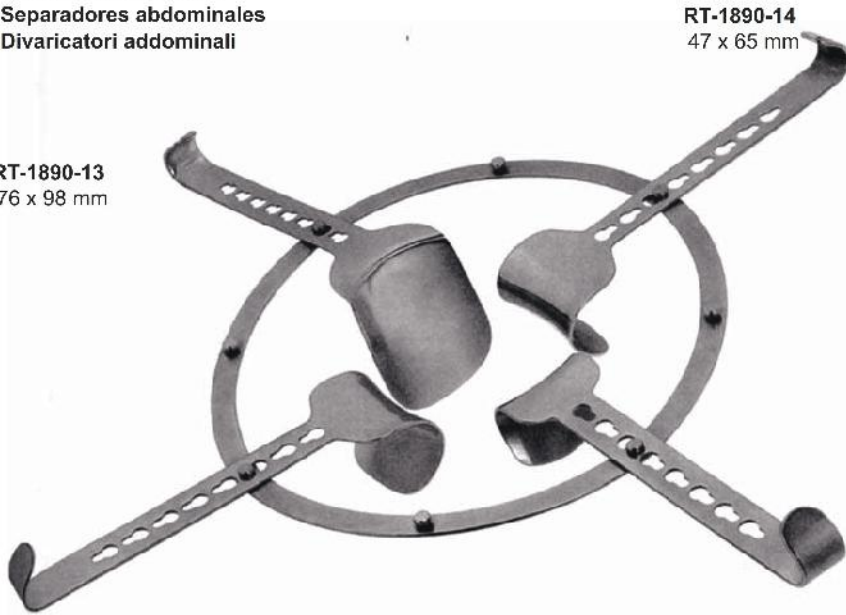

RT-1890-14  
47 x 65 mm



RT-1890-11  
98 x 52 mm

RT-1890-12  
105 x 35 mm

47 x 65 mm

RT-1890-01  
275 x 250 mm  
Rahmen allein  
frame only  
cuadro suelto  
solo telaio

RT-1890-15  
50 x 54 mm

RT-1900-13  
38 x 60 mm

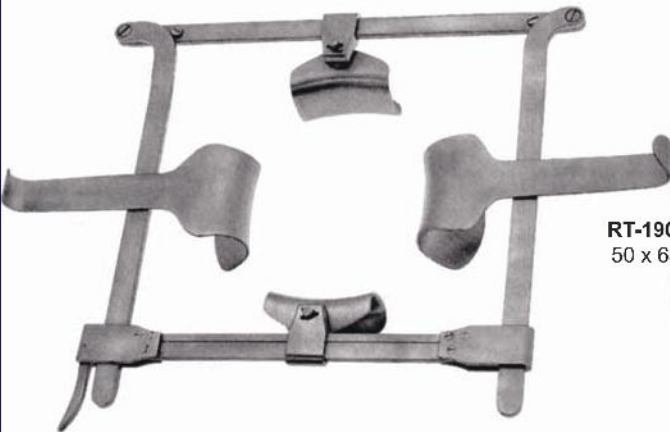

RT-1900-11  
50 x 65 mm

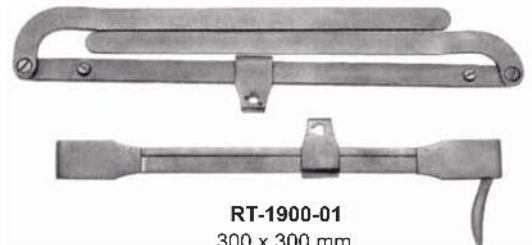

RT-1900-01  
300 x 300 mm  
zusammenlegbarer Rahmen, allein  
folding frame, only  
cuadro plegable, suelto  
telaio pieghevole, solo

**FRANZ**  
RT-1900-00  
komplett  
complete  
completo  
completo  
1 x 031-1900-01  
2 x 031-1900-11  
2 x 031-1900-13



38 x 60 mm RT-1900-13  
45 x 80 mm RT-1900-14



50 x 65 mm RT-1900-11  
60 x 85 mm RT-1900-12

Bauchdeckenhalter  
Abdominal Retractors  
Separadores abdominales  
Divaricatori addominali



95 x 60 mm **RT-1910-11**  
105 x 65 mm **RT-1910-12**  
115 x 65 mm **RT-1910-13**  
125 x 65 mm **RT-1910-14**

**DOYEN**  
28,0 cm, 11"

für / for / para / per  
031-1910-11  
031-1910-14



Kette mit Gewicht  
Chain with weight  
Cadena con pesa  
Catena con peso

**RT-1915-30**  
78,5 cm, 31"



53,0 cm, 21"

66,0 cm, 26"

Befestigungsgestell  
Mounting frame  
Bastidor para la fijación  
Telaio di supporto per il fissaggio

**ROCHARD**  
031-1920-01



53,0 cm, 21"

66,0 cm, 26"

Befestigungsgestell  
Mounting frame  
Bastidor para la fijación  
Telaio di supporto per il fissaggio

**ROCHARD**  
RT-1920-02

95 x 48 mm **RT-1920-10**  
105 x 48 mm **RT-1920-12**  
115 x 48 mm **RT-1920-13**  
125 x 48 mm **RT-1920-13**  
155 x 48 mm **RT-1920-16**



**ROCHARD**  
28,0 cm, 11"  
RT-1920-20

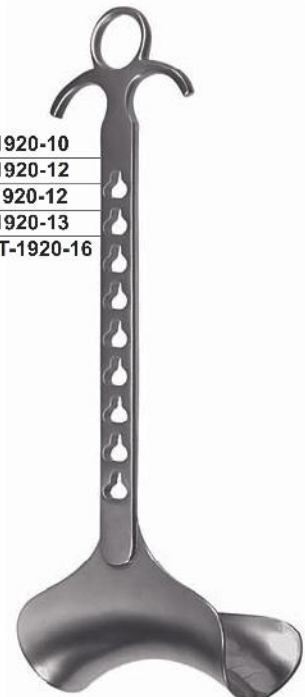

**ROCHARD**  
28,0 cm, 11"

**Bauchspatel**  
**Abdominal Spatulas**  
**Espátulas abdominales**  
**Spatole addominali**



biegsam  
malleable  
maleable  
malleabile

200 x 6 mm	RT-1210-06
200 x 12 mm	RT-1210-12
200 x 17 mm	RT-1210-17
200 x 20 mm	RT-1210-20
200 x 25 mm	RT-1210-25

**RIBBON**



biegsam  
malleable  
maleable  
malleabile

330 x 13 mm	RT-1170-13
330 x 25 mm	RT-1170-25
330 x 32 mm	RT-1170-32
330 x 40 mm	RT-1170-40
330 x 50 mm	RT-1170-50

**RIBBON**



biegsam  
malleable  
maleable  
malleabile

280 x 25/30 mm	RT-1200-01
300 x 37/45 mm	RT-1200-02
300 x 40/50 mm	RT-1200-03

**RIBBON**



biegsam  
malleable  
maleable  
malleabile

**TUFFIER**  
200 x 25/17 mm  
RT-1220-20



**REVERDIN**  
280 x 45/60 mm  
RT-1230-28

Rippensperrer  
Rib Spreaders  
Separadores costales  
Divaricatori costali



**FINOCCHIETTO-BABY**

a	b	c	
18 mm	20 mm	75 mm	<b>RT-1100-01</b>

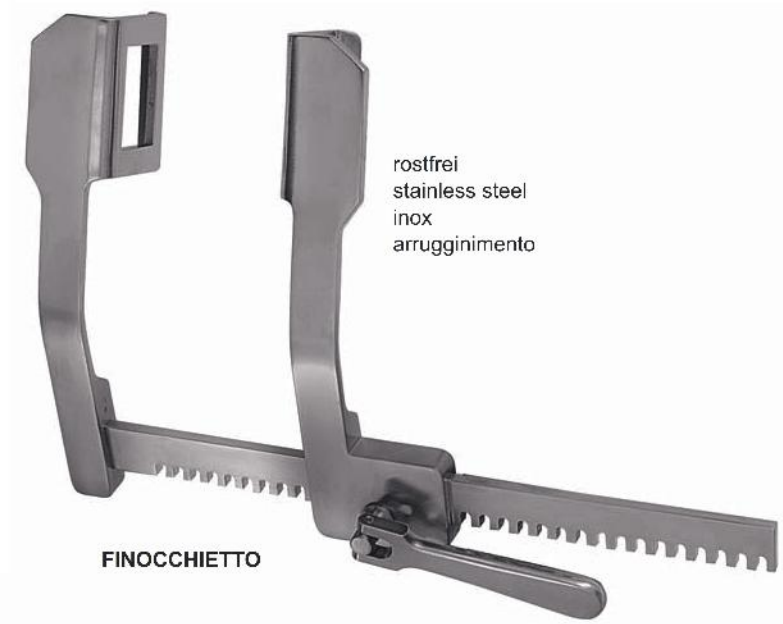

**FINOCCHIETTO**

a	b	c	
40 mm	40 mm	165 mm	<b>RT-1100-02</b>
45 mm	65 mm	200 mm	<b>RT-1100-03</b>
70 mm	65 mm	250 mm	<b>RT-1100-04</b>



**TUFFIER**

a	b	c	
50 mm	45 mm	165 mm	<b>RT-1150-01</b>





**Sonden, Trokare**  
**Probes, Trocars**  
**Sondas, Trócares**  
**Sonde, Trequarti**



Sonden  
Probes  
Sondas  
Sonde



	Ø 1,0 mm	Ø 2,0 mm
11,5 cm, 4 1/2"	<b>PT-1000-11</b>	<b>RT-1004-11</b>
13,0 cm, 5"	<b>PT-1000-13</b>	<b>RT-1004-13</b>
14,5 cm, 5 3/4"	<b>PT-1000-14</b>	<b>RT-1004-14</b>
16,0 cm, 6 1/4"	<b>PT-1000-16</b>	<b>RT-004-15</b>
18,0 cm, 7"	<b>PT-1000-18</b>	<b>RT-1004-18</b>
20,0 cm, 8"	<b>PT-1000-20</b>	<b>RT-1004-20</b>

Ø 2,0 mm



11,5 cm, 4 1/2"	<b>PT-1013-11</b>
13,0 cm, 5"	<b>PT-1013-13</b>
14,5 cm, 5 3/4"	<b>PT-1013-14</b>
16,0 cm, 6 1/4"	<b>PT-1013-16</b>
18,0 cm, 7"	<b>PT-1013-18</b>
20,0 cm, 8"	<b>PT-1013-20</b>

Ø 1,0 mm



Silber  
Silver  
Plata  
Argento

**STACKE**  
10,5 cm, 4 1/8"  
**PT-1033-10**



Myrtenblattsonden  
Myrtle leaf probes  
Sondas para mirto  
Sonde a foglia di mirto

11,5 cm, 4 1/2"	<b>PT-1027-11</b>
13,0 cm, 5"	<b>PT-1027-13</b>
14,5 cm, 5 3/4"	<b>PT-1027-14</b>
16,0 cm, 6 1/4"	<b>PT-1027-16</b>
18,0 cm, 7"	<b>PT-1027-18</b>
20,0 cm, 8"	<b>PT-1027-20</b>



**NÉLATON**  
16,0 cm, 6 1/4"  
**PT-1120-16**



**DOYEN**  
14,5 cm, 5 3/4"  
**PT-1117-14**



**BRODIE**  
20,0 cm, 8"  
**PT-1126-20**

Ø 3,5 mm

Ø 3,5 mm



11,5 cm, 4 1/2" **PT-1110-11**  
13,0 cm, 5" **PT-1110-13**  
14,5 cm, 5 3/4" **PT-1110-14**  
16,0 cm, 6 1/4" **PT-1110-16**  
18,0 cm, 7" **PT-1110-18**  
20,0 cm, 8" **PT-1110-20**

Ø 3,3 mm



13,0 cm, 5" **PT-1122-13**  
14,5 cm, 5 3/4" **PT-1122-14**  
16,0 cm, 6 1/2" **PT-1122-16**  
18,0 cm, 7" **PT-1122-18**



**LOCKHART-MUMMERY**  
16,5 cm, 6 1/2"  
**PT-1130-01**



**LOCKHART-MUMMERY**  
16,5 cm, 6 1/2"  
**PT-1130-02**

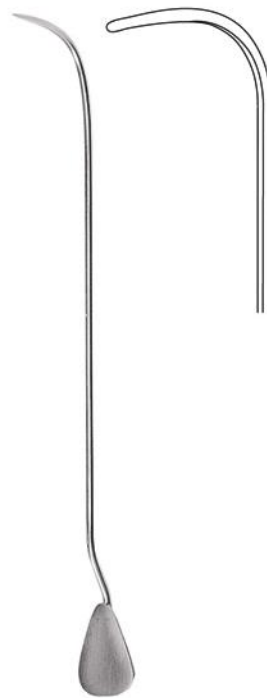

**LOCKHART-MUMMERY**  
16,5 cm, 6 1/2"  
**PT-1130-03**

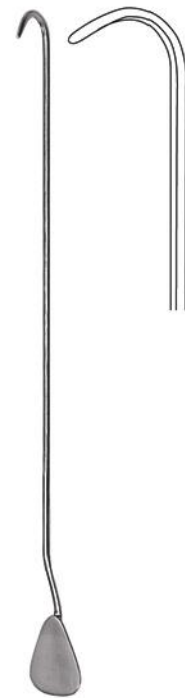

**LOCKHART-MUMMERY**  
16,5 cm, 6 1/2"  
**PT-1130-04**

Watteträger  
Cotton Applicators  
Porta-algodones  
Porta-cotone



**FEIN**  
28,0 cm, 11"  
PT-1264-28



**UKERMANN**  
16,0 cm, 6 1/4"  
PT-1260-16



**JOBSON-HORNE**  
18,0 cm, 7"  
PT-1262-18



12,0 cm, 4 3/4"	<b>PT-1271-12</b>	Ø 0,9 mm
14,0 cm, 5 3/4"	<b>PT-1271-14</b>	Ø 0,9 mm
16,5 cm, 6 1/4"	<b>PT-1271-16</b>	Ø 1,1 mm
18,0 cm, 7"	<b>PT-1271-18</b>	Ø 1,2 mm

**FARRELL**  
(LATHBURY)



12,0 cm, 4 3/4"	<b>PT-1270-12</b>	Ø 0,9 mm
14,0 cm, 5 3/4"	<b>PT-1270-14</b>	Ø 0,9 mm
16,5 cm, 6 1/4"	<b>PT-1270-16</b>	Ø 1,1 mm
18,0 cm, 7"	<b>PT-1270-18</b>	Ø 1,2 mm

**FARRELL**

Krampfader-Besteck  
Varicose Vein Probe Set  
Juego para várices  
Astuccio per varici



**PT-1150-01**  
Metalletui  
Metal case  
Estuche de metal  
Scatola in metallo

135 x 100 x 25 mm

**NABATOFF**  
**PT-1150-00**  
komplett  
complete  
completo  
completo



**PT-1150-21**  
Zugseil  
Cable  
Cable  
Fune

**PT-1150-22**  
Kunststoff-Sondenspitze  
Plastic probe tip  
Extremidad de sonda de plástico  
Punta in materia plastica



Ø 3,0 mm  
**PT-1150-03**



Ø 6,0 mm  
**PT-1150-06**



Ø 9,0 mm  
**PT-1150-09**



Ø 12,0 mm  
**PT-1150-12**

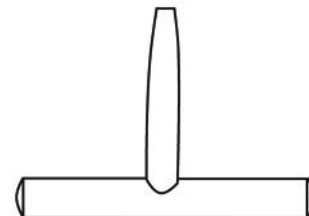

**PT-1150-20**  
Handgriff  
Handle  
Mango  
Manico

Trokare  
Trocars  
Trócares  
Trequarti



- Ø 3,0 mm
- Ø 3,5 mm
- Ø 4,0 mm
- Ø 4,5 mm
- Ø 5,0 mm
- Ø 5,5 mm
- Ø 6,0 mm

- PT-1110-30
- PT-1110-35
- PT-1110-40
- PT-1110-45
- PT-1110-50
- PT-1110-55
- PT-1110-60

**STANDARD**  
11,0 cm, 4<sup>3</sup>/<sub>8</sub>"



- Ø 3,0 mm
- Ø 3,5 mm
- Ø 4,0 mm
- Ø 4,5 mm
- Ø 5,0 mm
- Ø 5,5 mm
- Ø 6,0 mm

- PT-1112-30
- PT-1112-35
- PT-1112-40
- PT-1112-45
- PT-1112-50
- PT-1112-55
- PT-1112-60

**STANDARD**  
12,0 cm, 4<sup>3</sup>/<sub>4</sub>"



- Ø 3,0 mm
- Ø 3,5 mm
- Ø 4,0 mm
- Ø 4,5 mm
- Ø 5,0 mm
- Ø 5,5 mm
- Ø 6,0 mm

- PT-1114-30
- PT-1114-35
- PT-1114-40
- PT-1114-45
- PT-1114-50
- PT-1114-55
- PT-1114-60

**STANDARD**  
12,0 cm, 4<sup>3</sup>/<sub>4</sub>"



- Ø 7,3 mm
- Ø 8,7 mm
- Ø 12,0 mm

- PT-1118-07
- PT-1118-09
- PT-1118-12

**HURWITZ**



Ø 4,5 mm

Ø 3,0 mm

Ø 1,75 mm

**UNIVERSAL**  
PT-1100-03



Ø 6,0 mm

Ø 4,5 mm

Ø 3,0 mm

Ø 1,75 mm

**UNIVERSAL**  
PT-1100-04

Trokare  
Trocars  
Trócares  
Trequarti

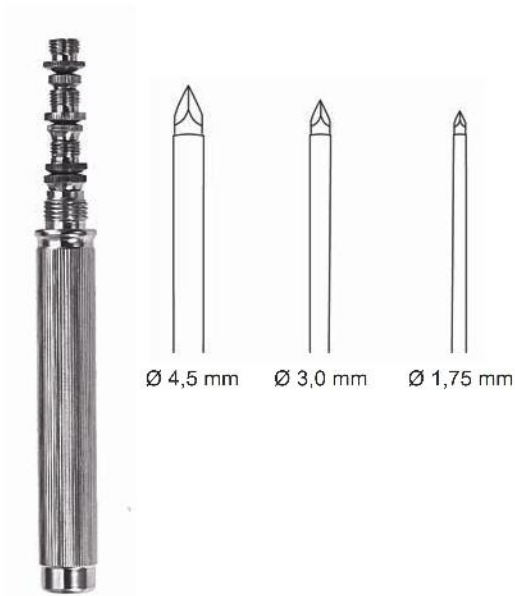

**UNIVERSAL**  
PT-1102-03

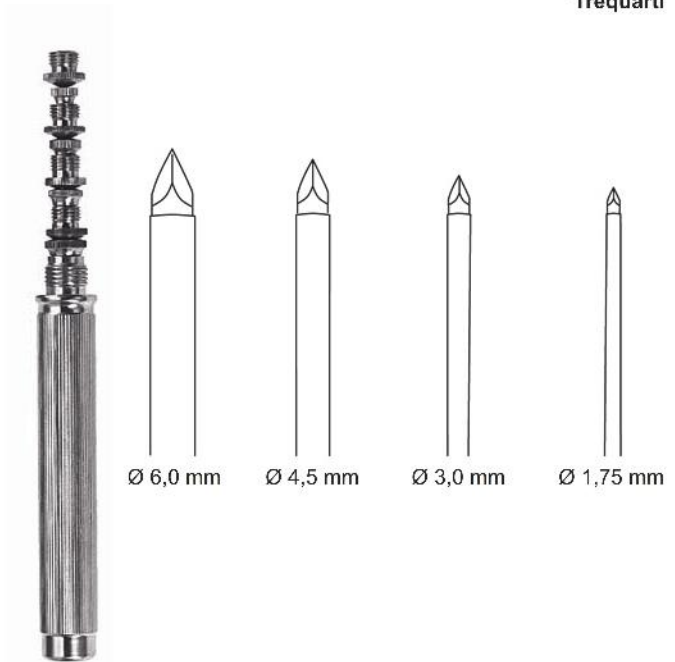

**UNIVERSAL**  
PT-1102-04

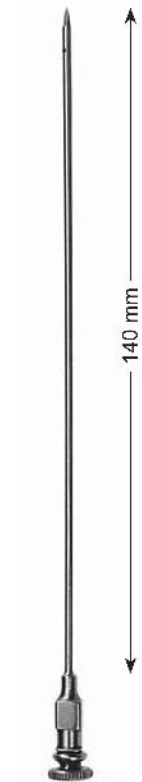

**LANDAU**  
Ø 2,0 mm  
PT-1160-16



**LANDAU**  
Ø 2,0 mm  
PT-1161-16



**DAVIDSON**  
Ø 6,0 mm  
PT-1164-18



**BUELAU**  
Ø 8,0 mm  
PT-1124-24

Trokare  
Trocars  
Trócares  
Trequarti



Ø 2,0 mm	<b>PT-1130-20</b>
Ø 2,5 mm	<b>PT-1130-25</b>
Ø 3,0 mm	<b>PT-1130-30</b>

**LERMOYEZ**



Ø 6,0 mm	<b>PT-1128-06</b>
Ø 8,0 mm	<b>PT-1128-08</b>

**CAMPBELL**  
16,0 cm, 6 1/4"



Ø 7,5 mm	<b>PT-1120-01</b>
Ø 9,0 mm	<b>PT-1120-02</b>
Ø 10,5 mm	<b>PT-1120-03</b>
Ø 12,0 mm	<b>PT-1120-04</b>

**NELSON**  
21,0 cm, 8 1/2"

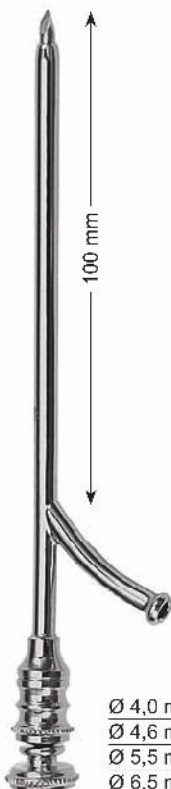

Ø 4,0 mm	<b>PT-1140-01</b>
Ø 4,6 mm	<b>PT-1140-02</b>
Ø 5,5 mm	<b>PT-1140-03</b>
Ø 6,5 mm	<b>PT-1140-04</b>

**OCHSNER**  
14,0 cm, 5 1/2"



Record Konus  
Record cone

Ø 3,0 mm	<b>PT-1180-30</b>
Ø 4,0 mm	<b>PT-1180-40</b>
Ø 5,0 mm	<b>PT-1180-50</b>

**PIERCE**  
16,0 cm, 6 1/4"



**COAKLEY**  
14,0 cm, 5 1/2"  
**PT-1190-14**





Ø 4,0 mm

**KRAUSE**  
16,0 cm, 6 1/4"

**LICHTWITZ**  
Kieferhöhlentrokare  
Antrum trocars  
Trócares para el seno maxilar  
Trequarti per puntura del seno mascellare

Ø 1,8 mm

Ø 3,0 mm **PT-1184-30**  
Ø 4,0 mm **PT-1184-40**  
Ø 5,0 mm **PT-1184-50**  
Ø 5,5 mm **PT-1184-55**



**LICHTWITZ**  
20,0 cm, 8"  
**PT-1170-00**

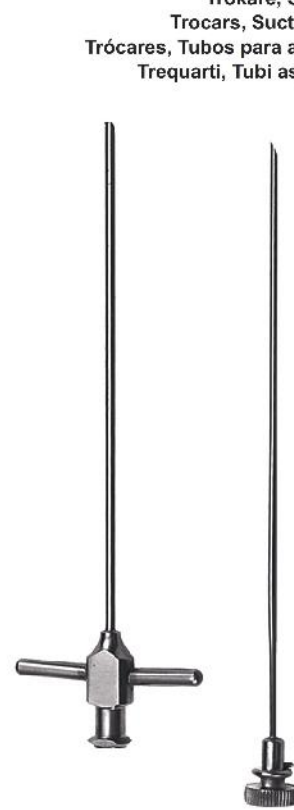

Trokare, Saugrohre  
Trocars, Suction Tubes  
Trócares, Tubos para aspiración  
Trequarti, Tubi aspirazione

**LICHTWITZ**  
11,0 cm, 4 1/2"  
**PT-1172-00**



**DOUGLAS**  
Ø 3,0 mm  
**ST-1175-00**



**POOLE**  
22,0 cm, 8 5/8"

Ø 6,0 mm **ST-1020-06**  
Ø 10,0 mm **ST-1020-10**



**POOLE**  
22,0 cm, 8 5/8"

Ø 6,0 mm **ST-1021-06**  
Ø 8,0 mm **ST-1021-08**

Saugrohre  
Suction Tubes  
Tubos para aspiración  
Tubi aspirazione



auswechselbare  
interchangeable  
punta intercambiar  
tipo intercambiar

Ø 3,5 mm  
ST-1010-35

**COUPLAND**  
17,0 cm, 6<sup>3</sup>/<sub>8</sub>"  
ST-1010-17



**ST-1024-00**  
Olive allein  
Olive only  
Oliva suelto  
Olivo solo

**YANKAUER**  
27,0 cm, 10<sup>3</sup>/<sub>8</sub>"  
ST-1000-27



**DE BAKEY**  
27,0 cm, 10<sup>3</sup>/<sub>8</sub>"  
ST-1008-27



**ANTHONY**  
26,0 cm, 10<sup>1</sup>/<sub>4</sub>"  
ST-1007-26



**ANDREWS-PYNCHON**  
24,0 cm, 9<sup>1</sup>/<sub>2</sub>"  
ST-1006-24



**COOLEY**  
35,0 cm, 13<sup>3</sup>/<sub>4</sub>"  
Ø 8,0 mm  
ST-1024-02



**COOLEY**  
30,0 cm, 11<sup>3</sup>/<sub>4</sub>"  
Ø 7,0 mm  
ST-1024-03



**COOLEY**  
31,0 cm, 11<sup>3</sup>/<sub>4</sub>"  
Ø 10,0 mm  
ST-1024-04



**COOLEY**  
33,0 cm, 13"  
Ø 8,0 mm  
ST-1024-01



Ø 2,0 mm

**COGSWELL**  
23,0 cm, 9"  
ST-1014-23

Saugrohre  
Suction Tubes  
Tubos para aspiración  
Tubi aspirazione



Ø 1,5 mm	ST-1012-15
Ø 2,5 mm	ST-1012-25
Ø 3,5 mm	ST-1012-35

**BYRD**  
20,0 cm, 8"



**HEPP/SCHIEDEL**  
22,5 cm, 8<sup>3</sup>/<sub>4</sub>"  
ST-1016-22

Ø 4,0 mm



**ADSON**  
21,0 cm, 8<sup>1</sup>/<sub>4</sub>"  
ST-1050-21



Ø 1,0 mm	ST-1060-01
Ø 2,0 mm	ST-1060-02
Ø 3,0 mm	ST-1060-03
Ø 4,0 mm	ST-1060-04

**MAGILL**  
17,5 cm, 6<sup>3</sup>/<sub>8</sub>"



**FRAZIER**  
19,0 cm, 7<sup>1</sup>/<sub>2</sub>"

Charr. 6	ST-1030-06
Charr. 8	ST-1030-08
Charr. 10	ST-1030-10
Charr. 12	ST-1030-12



**FERGUSON**  
18,0 cm, 7"

Charr. 6	ST-1033-06
Charr. 8	ST-1033-08
Charr. 10	ST-1033-10
Charr. 12	ST-1033-12



**POPPEN**  
13,0 cm, 5"

Charr. 6	ST-1034-06
Charr. 8	ST-1034-08
Charr. 10	ST-1034-10
Charr. 12	ST-1034-12



**Galle, Leber, Niere, Blase, Urologie  
Gall, Liver, Kidney, Bladder, Urology  
Bilis, Hígado, Riñon, Vejiga, Urología  
Bile, Fegato, Rene, Vescica, Urologia**



Nierensteinzangen, Gallensteinzangen  
 Kidney Stone Forceps, Gall Stone Forceps  
 Pinzas para los cálculos renales, Pinzas para los cálculos biliares  
 Pinze per calcoli renali, Pinze per calcoli biliari



**RANDALL**

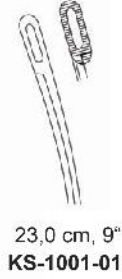

23,0 cm, 9"  
**KS-1001-01**



22,0 cm, 8<sup>5</sup>/<sub>8</sub>"  
**KS-1001-02**

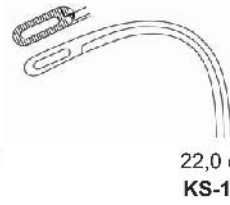

22,0 cm, 8<sup>5</sup>/<sub>8</sub>"  
**KS-1001-03**



22,0 cm, 8<sup>5</sup>/<sub>8</sub>"  
**KS-1001-04**

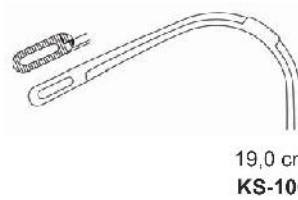

19,0 cm, 7<sup>1</sup>/<sub>2</sub>"  
**KS-1001-05**

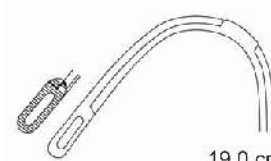

19,0 cm, 7<sup>1</sup>/<sub>2</sub>"  
**KS-1001-06**



**DESJARDINS**  
 23,0 cm, 9"



**KS-1001-01**

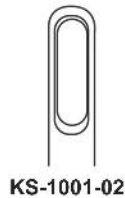

**KS-1001-02**



**MIXTER**  
 22,0 cm, 8<sup>5</sup>/<sub>8</sub>"  
**KS-1021-22**



**MAYO BLAKE**  
 20,0 cm, 8"  
**KS-1008-20**



20,0 cm, 8"  
**KS-1009-20**

Gallensteinzangen  
Gall Stone Forceps  
Pinzas para los cálculos biliares  
Pinze per calcoli biliari



**BLAKE**  
20,0 cm, 8"  
KS-1006-20

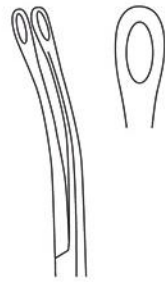

20,0 cm, 8"  
KS-1005-20



**TURNER-WARWICK**  
18,0 cm, 7"

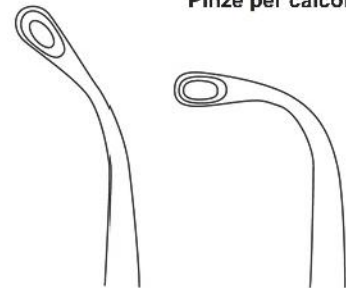

KS-1031-01

KS-1031-01



**SÖKELAND**  
24,0 cm, 9½"  
KS-1037-24

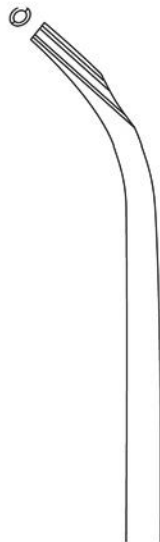

**CZERNY**  
24,5 cm, 9⅝"  
KS-1039-24



Gallensteinlöffel  
 Gall Stone Scoops  
 Cucharillas para los cálculos biliares  
 Cucchiari per calcoli biliari

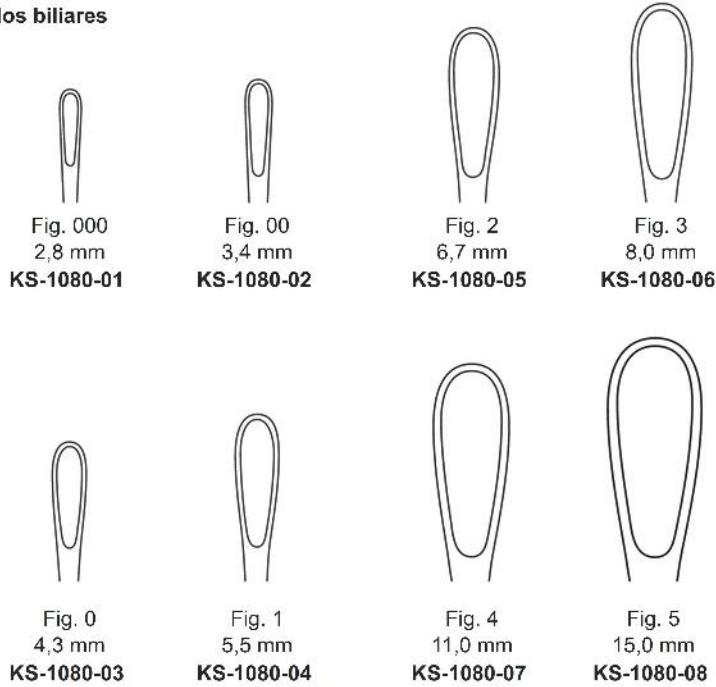

**LUER-KÖRTE**  
 24,0 cm, 9 1/2"



**FERGUSON**  
 21,5 cm, 8 1/2"  
 KS-1070-01



**MAYO**  
 27,0 cm, 10 5/8"  
 KS-1072-01



**MAYO**  
 27,0 cm, 10 5/8"



KS-1074-01



KS-1074-02



**MOYNIHAN**  
 34,0 cm, 13 3/8"  
 KS-1076-34

Gallengangsonden, Gallengang Dilatatore  
 Gall Duct Probes, Common Bile Duct Dilators  
 Sonas p. el conducto biliar, Diladores para el conducto biliar  
 Dilatatori per condotti biliari, Dilatatori per coledoco



**MATU**  
32,0 cm, 12 $\frac{1}{2}$ "  
KS-1078-32



**OCHSNER**  
35,0 cm, 13 $\frac{3}{4}$ "  
KS-1082-35



**DESJARDINS**  
28,0 cm, 11"

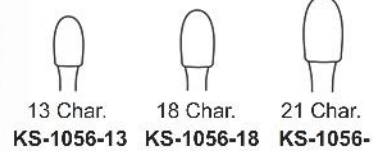

**MOORE**  
30,0 cm, 12"  
KS-1084-30

Gallenblasenlöffel  
 Gall bladder scoope  
 Cuccharilla para la vesicula biliar  
 Cucchiaio per colecisti



**DESJARDINS**  
28,0 cm, 11"

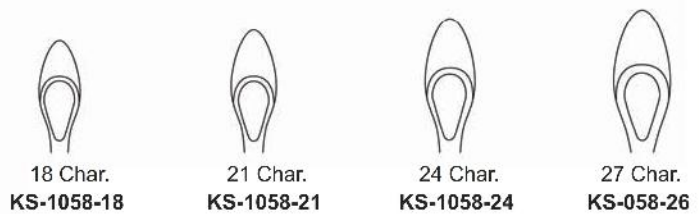



Gallengang Dilatoren  
 Common Bile Duct Dilators  
 Diladores para el conducto biliar  
 Dilatori per coledoco



**BAKES**  
 30,0 cm, 11<sup>3</sup>/<sub>4</sub>"  
 KS-1000-30

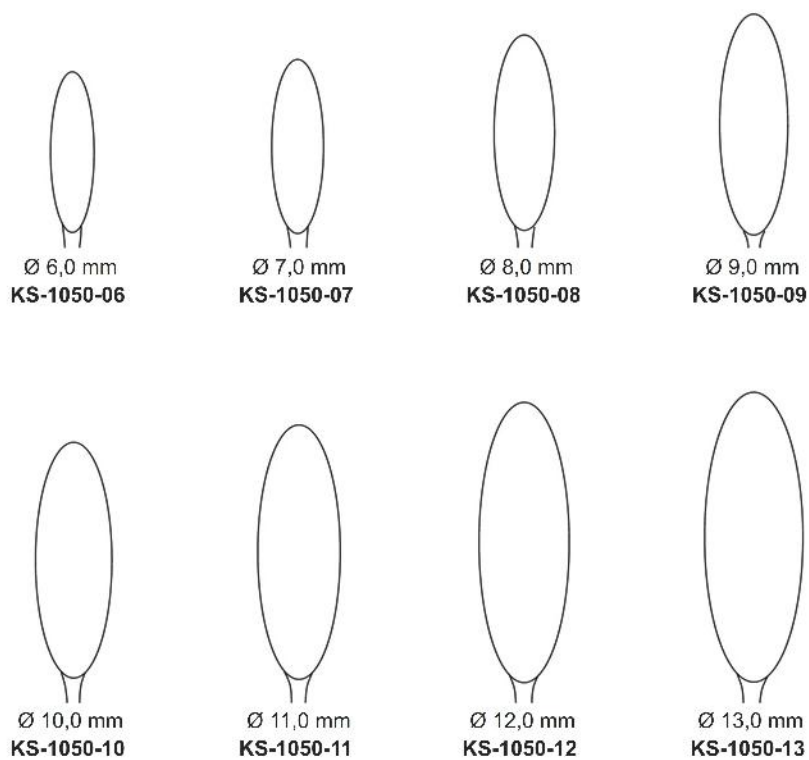

Blasenwundspreizer  
Bladder Retractors  
Deparadores para la vejiga  
Divaricatori vescicali

2 x  
57 x 25 mm  
056-1176-03



**THOMSON-WALKER**  
BT-1182-00

120 x 45 mm  
056-1176-02



**MILLIN**  
BT-1176-00

056-1176-01

← 110 mm →

73 x 28 mm



**JUDD-MASSON**  
BT-1172-00

← 95 mm →

27 x 60 mm

80 x 31 mm

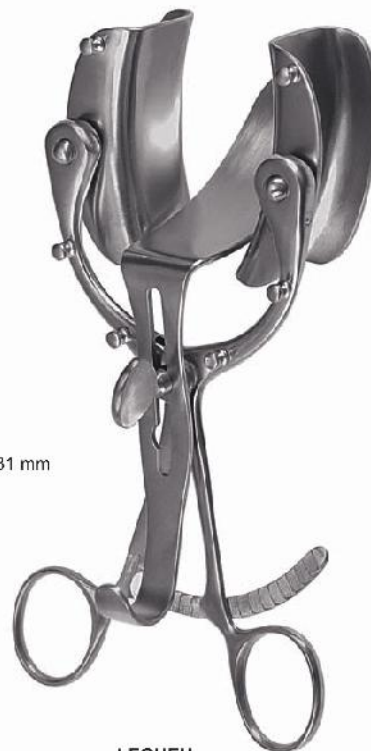

**LEGUEU**  
BT-1160-00

Instrumente für Prostatektomie  
Prostatectomy Instruments  
Instrumentos para la prostatectomía  
Strumenti per operazioni della prostata



**MILLIN**  
23,0 cm, 9"  
PT-1073-23



**ATRAUMA**

**MILLIN**  
24,0 cm, 9½"  
PT-1071-24



**MILLIN**  
24,0 cm, 9½"  
PT-1077-24



**MILLIN**  
23,0 cm, 9"  
PT-1075-23



**MILLIN**  
28,5 cm, 11¼"  
PT-1150-24

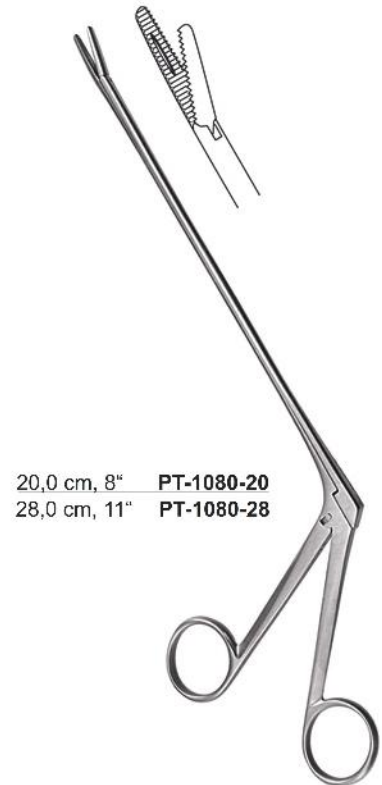

20,0 cm, 8" PT-1080-20  
28,0 cm, 11" PT-1080-28

**MATHIEU**

Prostatahaken, Blasenspatel  
Prostatic Retractors, Bladder Retractor  
Separadores para la prostata, Separadores vesicales  
Retrattori prostatici, Divaricatori vescicali



**YOUNG**  
21,0 cm, 8 $\frac{1}{4}$ "  
BT-1230-21



**YOUNG**  
22,0 cm, 8 $\frac{5}{8}$ "  
BT-1236-22



**YOUNG**  
21,0 cm, 8 $\frac{1}{4}$ "  
BT-1238-21

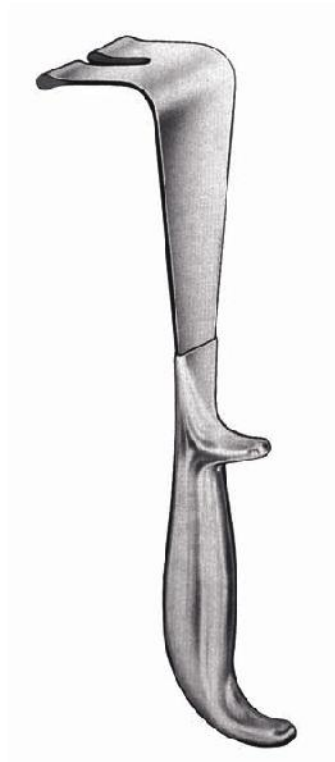

**YOUNG**  
22,0 cm, 8 $\frac{5}{8}$ "  
BT-1240-22



**LEGUEU**  
26,0 cm, 10 $\frac{1}{4}$ "  
BT-1250-26



**KOCHER**  
23,5 cm, 9 $\frac{1}{4}$ "  
BT-1257-23

Katheter, Penisklemmen  
Catheters, Penis Clamp  
Sondas, Compresor urétral  
Cateteri, Serrapene



für Männer  
for men  
para hombres  
per uomini

Char. 8	CT-1650-08
Char. 10	CT-1650-10
Char. 12	CT-1650-12
Char. 14	CT-1650-14
Char. 16	CT-1650-16
Char. 18	CT-1650-18
Char. 20	CT-1650-20
Char. 22	CT-1650-22
Char. 24	CT-1650-24

29,0 cm, 11½"



für Frauen  
for women  
para mujeres  
per donne

Char. 6	CT-1660-06
Char. 7	CT-1660-07
Char. 8	CT-1660-08
Char. 9	CT-1660-09
Char. 10	CT-1660-10
Char. 11	CT-1660-11
Char. 12	CT-1660-12
Char. 13	CT-1660-13
Char. 14	CT-1660-14
Char. 15	CT-1660-15
Char. 16	CT-1660-16
Char. 18	CT-1660-18
Char. 20	CT-1660-20
Char. 24	CT-1660-24

16,0 cm, 6¼"



**STRAUSS**  
11,0 cm, 4⅓"  
056-1349-11



**STOCKMANN**  
8,0 cm, 3¼"  
CT-1345-08

Ø 8,0 mm	CT-1350-08
Ø 11,0 mm	CT-1350-11
Ø 13,0 mm	CT-1350-13
Ø 16,0 mm	CT-1350-16
Ø 21,0 mm	CT-1350-21
Ø 26,0 mm	CT-1350-26
Ø 32,0 mm	CT-1350-32



**COMCO**



**Magen, Darm, Mastdarm**  
**Stomach, Intestines, Rectum**  
**Estómago, Intestino, Recto**  
**Stomaco, Intestino, Retto**



Darm- und Gewebefazangen  
 Intestinal and Tissue Grasping Forceps  
 Pinzas intestinales y para tejidos  
 Pinze da presa per intestino e tessuti

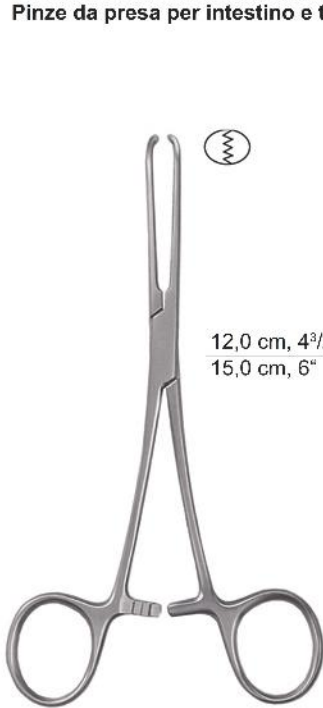

12,0 cm, 4<sup>3</sup>/<sub>4</sub>" TF-1000-12  
 15,0 cm, 6" TF-1000-15

ALLIS-BABY

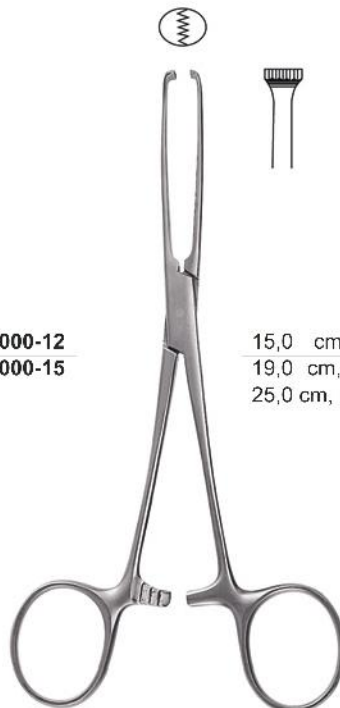

15,0 cm, 6" TF-1004-15  
 19,0 cm, 7<sup>1</sup>/<sub>2</sub>" TF-1004-19  
 25,0 cm, 9<sup>3</sup>/<sub>4</sub>" TF-1004-25

ALLIS

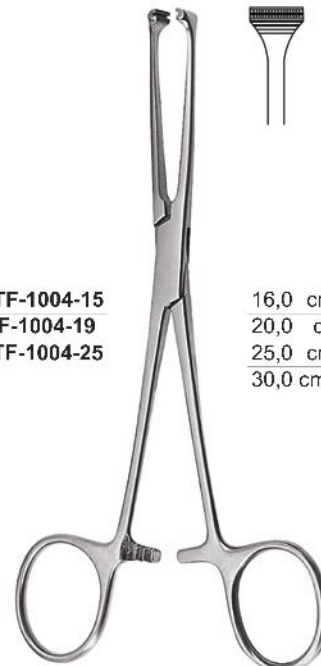

16,0 cm, 6<sup>1</sup>/<sub>4</sub>" TF-1124-16  
 20,0 cm, 8" TF-1124-20  
 25,0 cm, 9<sup>3</sup>/<sub>4</sub>" TF-1124-25  
 30,0 cm, 11<sup>3</sup>/<sub>4</sub>" TF-1124-30

ALLIS-ATRAUMA



15,5 cm, 6" TF-1020-15  
 20,0 cm, 8" TF-1020-20  
 23,0 cm, 9" TF-1020-23

ALLEN

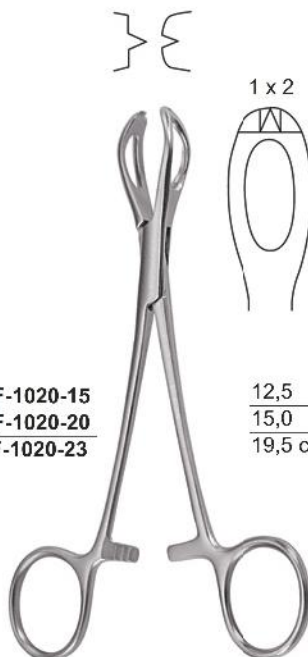

12,5 cm, 5" TF-1030-12  
 15,0 cm, 6" TF-1030-15  
 19,5 cm, 7<sup>3</sup>/<sub>4</sub>" TF-1030-19

LANE

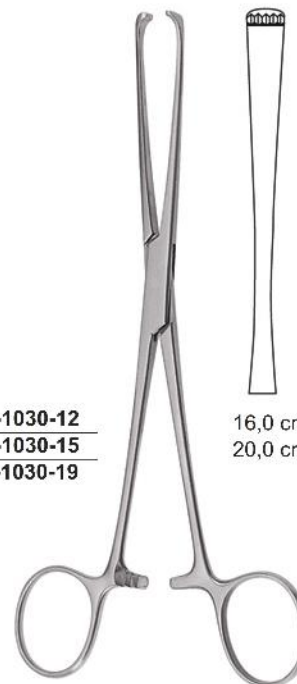

16,0 cm, 6<sup>1</sup>/<sub>4</sub>" TF-1178-16  
 20,0 cm, 8" TF-1178-20

LOCKWOOD-ALLIS

Darm- und Gewebefaßzangen  
Intestinal and Tissue Grasping Forceps  
Pinzas intestinales y para tejidos  
Pinze da presa per intestino e tessuti



15,0 cm, 6" TF-1040-15  
19,0 cm, 7½" TF-1040-19

**JUDD-ALLIS**



**LITTLEWOOD**  
18,5 cm, 7¼"  
TF-1060-16



**ALLIS-ADAIR**  
15,5 cm, 6"  
TF-1010-15



**BOYS-ALLIS**  
15,5 cm, 6"  
TF-1012-15



**THOMS-ALLIS**  
20,0 cm, 8"  
TF-1050-20



**ALLIS**  
20,0 cm, 8"  
TF-1014-20



Darm- und Gewebefäßzangen  
 Intestinal and Tissue Grasping Forceps  
 Pinzas intestinales y para tejidos  
 Pinze da presa per intestino e tessuti



**LOCKWOOD**  
 20,0 cm, 8"  
 TF-1178-20

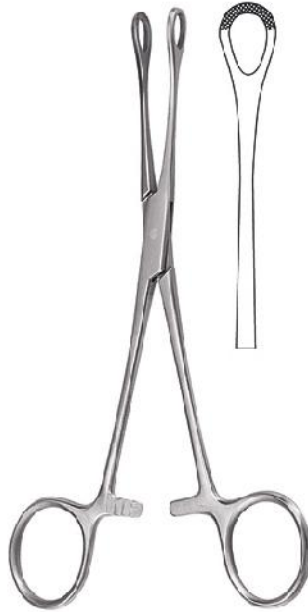

**WILLIAMS**  
 16,0 cm, 6 1/4"  
 TF-1070-16

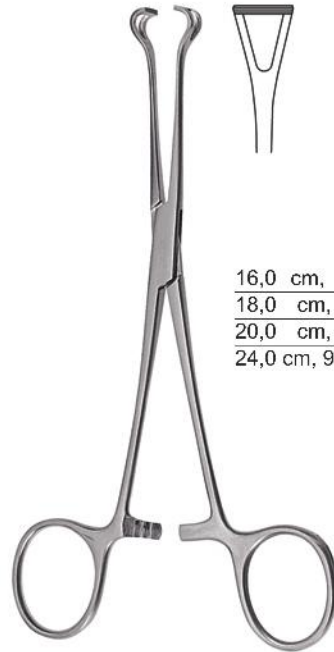

**BABCOCK**

- 16,0 cm, 6 1/4" TF-1006-16
- 18,0 cm, 7" TF-1006-18
- 20,0 cm, 8" TF-1006-20
- 24,0 cm, 9 1/2" TF-1006-24



**BABCOCK-ATRAUMA**

- 16,0 cm, 6 1/4" TF-1006-16
- 20,0 cm, 8" TF-1006-20



**BABCOCK-TC**

- 16,0 cm, 6 1/4" TF-1006-16
- 20,0 cm, 8" TF-1006-20



**DUVAL-TC**  
 20,0 cm, 8"  
 TF-1170-20

Darmklemmen  
Intestinal Clamp Forceps  
Pinzas-clamps intestinales  
Pinze intestinali



18,0 cm, 7"	<b>TF-1170-18</b>	
20,0 cm, 8"	<b>TF-1170-20</b>	<b>TF-1172-20</b>
23,0 cm, 9"		<b>TF-1172-23</b>

Darm- und Gewebefäßzangen  
Intestinal and Tissue Grasping Forceps  
Pinzas intestinales y para tejidos  
Pinze da presa per intestino e tessuti

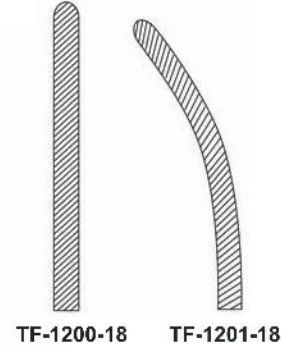
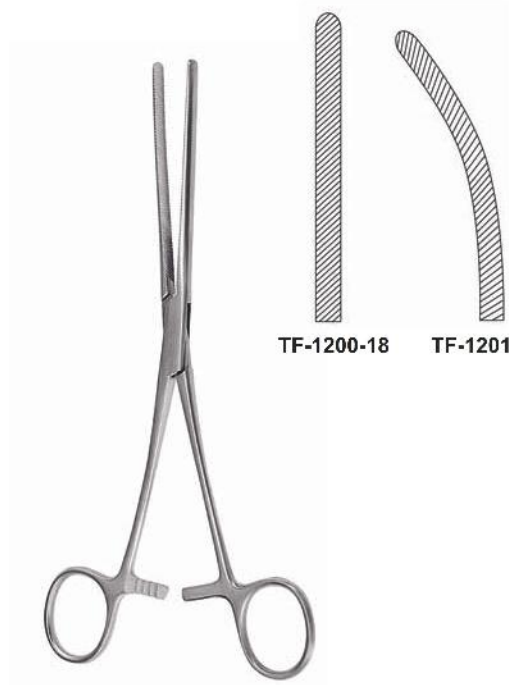
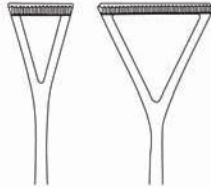

21,0 cm, 8 1/4"	<b>TF-1210-21</b>
23,0 cm, 9"	<b>TF-1210-23</b>

21,0 cm, 8 1/4"	<b>TF-1211-21</b>
23,0 cm, 9"	<b>TF-1211-23</b>

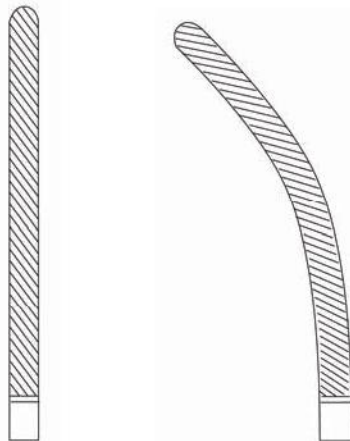

Darmklemmen  
 Intestinal Clamp Forceps  
 Pinzas-clamps intestinales  
 Pinze intestinali



DOYEN



21,0 cm, 8<sup>1</sup>/<sub>4</sub>" **TF-1210-21**  
 23,0 cm, 9" **054-1210-23**

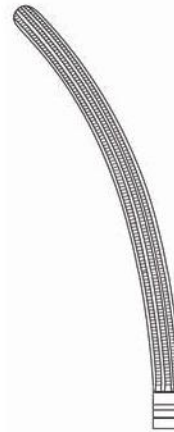

21,0 cm, 8<sup>1</sup>/<sub>4</sub>" **TF-1211-21**  
 23,0 cm, 9" **TF-1211-23**

mit atraumatischer Zahnung  
 with atraumatic serration  
 con bacos atraumáticos  
 con morsi atraumatici



KOCHER



22,0 cm, 8<sup>5</sup>/<sub>8</sub>" **TF-1234-22**  
 25,0 cm, 9<sup>3</sup>/<sub>4</sub>" **TF-1234-25**  
 28,0 cm, 11" **TF-1234-28**



22,0 cm, 8<sup>5</sup>/<sub>8</sub>" **TF-1235-22**  
 25,0 cm, 9<sup>3</sup>/<sub>4</sub>" **TF-1235-25**  
 28,0 cm, 11" **TF-1235-28**

Darmklemmen  
Intestinal Clamp Forceps  
Pinzas-clamps intestinales  
Pinze intestinali



mit atraumatischer Zahnung  
with atraumatic serration  
con bacos atraumáticas  
con morsi atraumatici

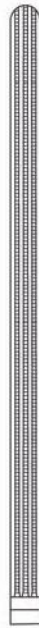

22,0 cm, 8<sup>5</sup>/<sub>8</sub>" TF-1234-22  
25,0 cm, 9<sup>3</sup>/<sub>4</sub>" TF-1234-25  
28,0 cm, 11" TF-1234-28



22,0 cm, 8<sup>5</sup>/<sub>8</sub>" TF-1234-22  
25,0 cm, 9<sup>3</sup>/<sub>4</sub>" TF-1234-25  
28,0 cm, 11" TF-1234-28



21,0 cm, 8<sup>1</sup>/<sub>4</sub>" TF-1230-21  
23,0 cm, 9" TF-1230-23  
25,0 cm, 9<sup>3</sup>/<sub>4</sub>" TF-1230-25



21,0 cm, 8<sup>1</sup>/<sub>4</sub>" TF-1231-21  
23,0 cm, 9" TF-1231-23  
25,0 cm, 9<sup>3</sup>/<sub>4</sub>" TF-1231-25

Darmklemmen  
 Intestinal Clamp Forceps  
 Pinzas-clamps intestinales  
 Pinze intestinali



**MAYO-ROBSON**

21,0 cm, 8<sup>1</sup>/<sub>4</sub>" **TF-1230-21**  
 23,0 cm, 9" **TF-1230-23**  
 25,0 cm, 9<sup>3</sup>/<sub>4</sub>" **TF-1230-25**

mit atraumatischer Zahnung  
 with atraumatic serration  
 con bacos atraumáticos  
 con morsi atraumatici



21,0 cm, 8<sup>1</sup>/<sub>4</sub>" **TF-1231-21**  
 23,0 cm, 9" **TF-1231-23**  
 25,0 cm, 9<sup>3</sup>/<sub>4</sub>" **TF-1231-25**

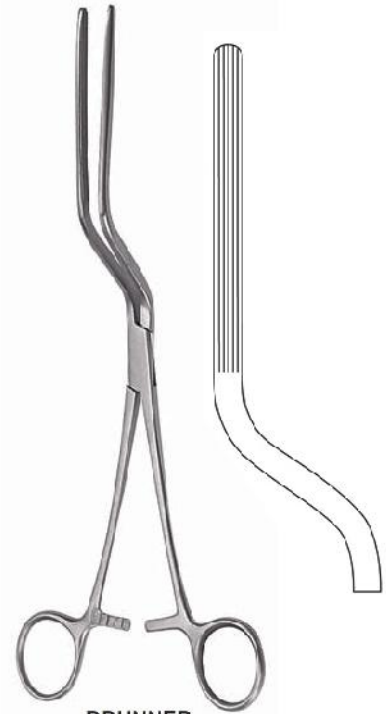

**BRUNNER**  
 24,0 cm, 9<sup>1</sup>/<sub>2</sub>"  
**TF-1240-24**

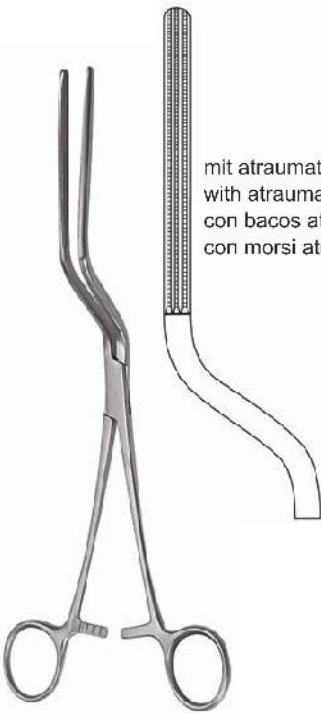

**BRUNNER**  
 24,0 cm, 9<sup>1</sup>/<sub>2</sub>"  
**TF-1240-24**

mit atraumatischer Zahnung  
 with atraumatic serration  
 con bacos atraumáticos  
 con morsi atraumatici



**GLASSMAN**  
 23,0 cm, 9"  
**TF-1259-23**

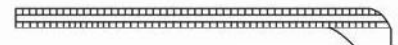

**GLASSMAN**  
 23,5 cm, 9<sup>1</sup>/<sub>4</sub>"  
**TF-1253-23**

Darm- und Magenquetschklemmen  
 Intestinal and Stomach Clamps  
 Pinzas-clamps intestinales y estomacales  
 Pinze/Clamp per intestino e stomaco



Maullänge  
 length of jaws  
 longitud de la boca  
 bocche lungh.

5,0 cm, 2"	SC-1320-05
7,0 cm, 2 1/2"	SC-1320-07
10,0 cm, 4"	SC-1320-10

DE MARTEL-WOLFSON



DE MARTEL-WOLFSON  
 8,5 cm, 3 1/2"  
 SC-1340-08



DE MARTEL-WOLFSON  
 26,0 cm, 10 1/4"  
 SC-1325-26



BABY-PAYR  
 15,0 cm, 6"

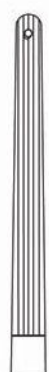

SC-1310-15  
 mit Stift  
 with pin  
 con espiga  
 con perno



SC-1311-15  
 ohne Stift  
 without pin  
 sin espiga  
 senza perno



PAYR



21,0 cm, 8 1/4" SC-1310-21  
 29,0 cm, 11 1/2" SC-1310-29 SC-1311-21

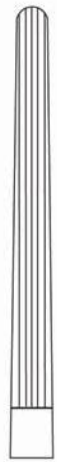

mit Stift  
 with pin  
 con espiga  
 con perno

ohne Stift  
 without pin  
 sin espiga  
 senza perno

Darm- und Magenklappen  
 Intestinal and Stomach Clamp Forceps  
 Pinzas-clamps intestinales y estomacales  
 Pinze per intestino e stomaco



SC-1360-30

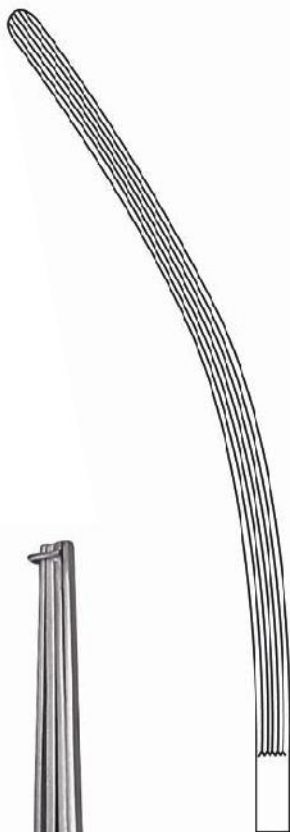

SC-1361-30

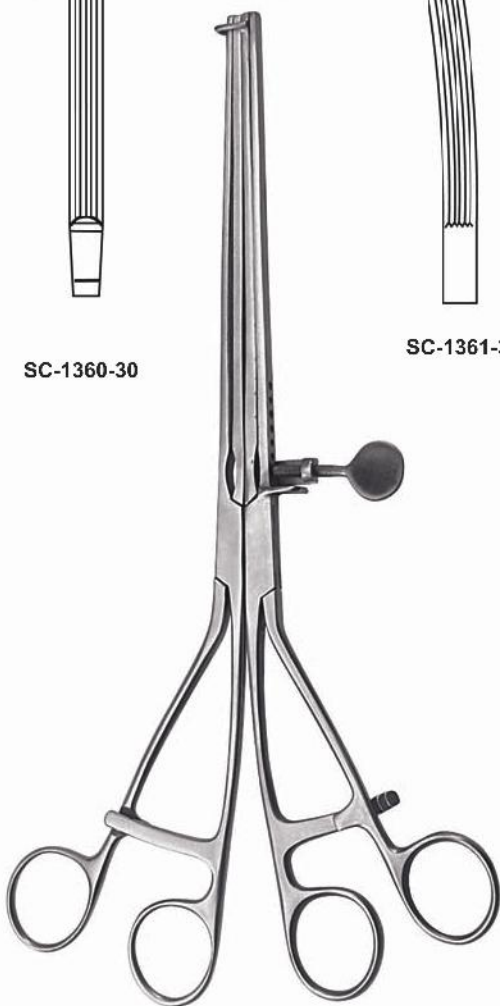

**LANE**  
 30,0 cm, 11<sup>3</sup>/<sub>4</sub>"

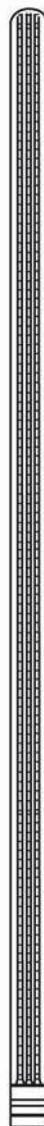

SC-1364-33



SC-1365-33

mit atraumatischer Zahnung  
 with atraumatic serration  
 con bacos atraumáticas  
 con morsi atraumatici



**SCUDDER**  
 33,0 cm, 13"

Rektum-Anastomosenklemmen  
Sigmoid Anastomosis Forceps  
Pinzas para anastomosis de recto  
Pinze per anastomosi de recto



**MIKULICZ**  
19,0 cm, 7 1/2"  
SC-1010-19

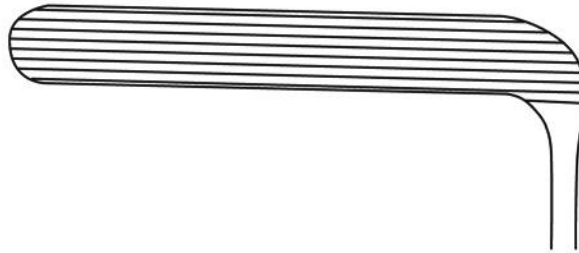

**HAYES**

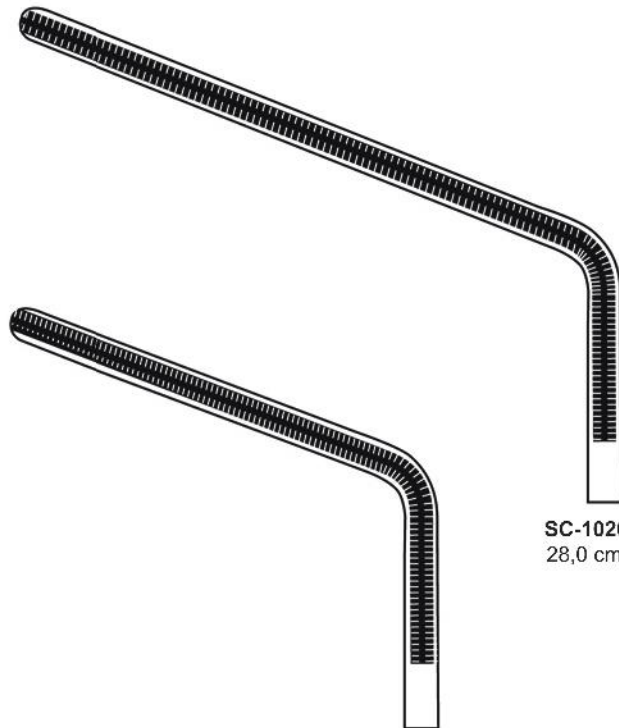

**SC-1020-28**  
28,0 cm, 11"

**SC-1020-26**  
26,0 cm, 10"



Mastdarm-Rektum-Spekula  
Rectal Specula  
Espéculos para el recto  
Speculi rettali



17 x 89 mm

**SIMS**  
15,0 cm, 6"  
SC-1108-15



17 x 89 mm

**SIMS**  
15,0 cm, 6"  
SC-1110-15



25 x 89 mm

**MATHIEU**  
21,0 cm, 8 1/4"  
SC-1150-21



75 x 23 mm

**SMITH-BUIE**  
15,0 cm, 6"  
SC-1160-15

Analnspreizer, Sphinkterskope, Anuskope  
Rectal Retractor, Sphincteroscopes, Anoscope  
Separadores para el recto, Esfinteroscopios, Anoscopios  
Dilatatori per l'ano ed il retti, Sfinteroscopi, Anoscopi



SC-1200-00



HAYES



HIRSCHMANN

Anuskope, Proktoskope  
Anoscope, Proctoscopes  
Anoscopios, Proctoscopios  
Anoscopi, Protoscopi



Ø 22 x 65 mm **SC-1250-22**  
Ø 30 x 65 mm **SC-1250-30**

**CHELSEA EATON**



ohne Kaltlichtträger  
without cold light carrier  
sin portador para luz fría  
senza luce fredda

**IVES FANSLER**  
Ø 22 mm  
**SC-1268-01**

mit Kaltlichtträger  
with cold light carrier  
con portador para luz fría  
con luce fredda

**IVES FANSLER**  
Ø 22 mm  
**SC-1268-02**



Ø 17 x 65 mm **SC-1220-01**  
Ø 17 x 80 mm **SC-1220-02**  
Ø 20 x 65 mm **SC-1220-03**  
Ø 20 x 80 mm **SC-1220-04**  
Ø 24 x 65 mm **SC-1220-05**  
Ø 24 x 80 mm **SC-1220-06**

**MORGAN**



**055-1000-02**



Ø 25 x 65 mm **SC-1124-25**  
Ø 29 x 65 mm **SC-1124-29**  
Ø 38 x 70 mm **SC-1124-38**

**FANSLER**

Mastdarm-Biopsiezangen  
 Rectal Biopsy Forceps  
 Pinzas sacabocado para biopsia rectal  
 Pinze taglianti per biopsia rettale



28,0 cm, 11" **SC-1300-28**  
 35,0 cm, 13<sup>3</sup>/<sub>4</sub>" **SC-1300-35**  
 42,0 cm, 16<sup>1</sup>/<sub>2</sub>" **SC-1300-42**



28,0 cm, 11" **SC-1311-28**  
 35,0 cm, 13<sup>3</sup>/<sub>4</sub>" **SC-1311-35**  
 42,0 cm, 16<sup>1</sup>/<sub>2</sub>" **SC-1311-42**

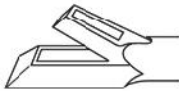

28,0 cm, 11" **SC-1301-28**  
 35,0 cm, 13<sup>3</sup>/<sub>4</sub>" **SC-1301-35**  
 42,0 cm, 16<sup>1</sup>/<sub>2</sub>" **SC-1301-42**



28,0 cm, 11" **SC-1312-28**  
 35,0 cm, 13<sup>3</sup>/<sub>4</sub>" **SC-1312-35**  
 42,0 cm, 16<sup>1</sup>/<sub>2</sub>" **SC-1312-42**



Hämorrhoiden-Ligator mit Ladekonus  
 Haemorrhoidal ligator with loading attachment  
 Ligador para hemorroides con cono de carga  
 Legatori emorroidali con carica a cono

**RUDD**  
**SC-1400-00**

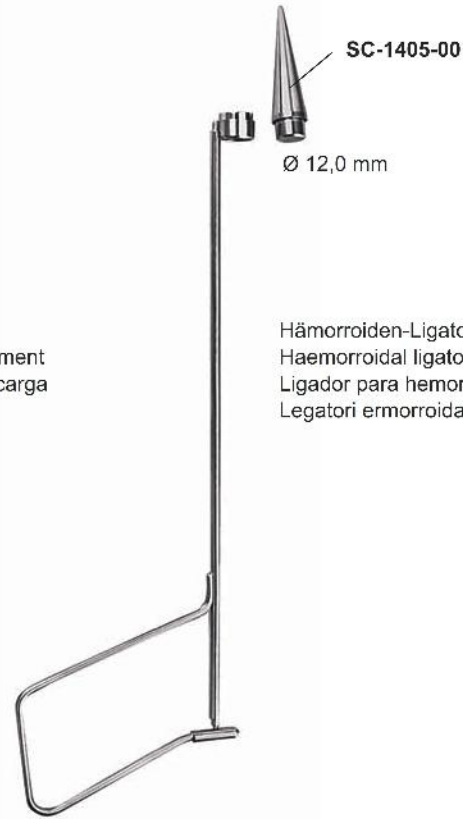

Hämorrhoiden-Ligator mit Ladekonus  
 Haemorrhoidal ligator with loading attachment  
 Ligador para hemorroides con cono de carga  
 Legatori emorroidali con carica a cono

**MC GIVNEY**  
**SC-1410-00**

Hämorrhoiden-Faßzangen, Fistelsonden  
Haemorrhoidal Forceps, Fistula probes  
Pinza-clamps para hemorroides, Sondas para fistula  
Pinze per emorroidi, Sonde per fistola



**MC GIVNEY**  
19,0 cm, 7½"  
SC-1471-19



**MC GIVNEY**  
19,0 cm, 7½"  
SC-1473-19



**PRATT**  
21,0 cm, 8¼"



SC-1135-01



SC-1135-02



SC-1135-03



**Gynäkologie, Geburtshilfe**  
**Gynecology, Obstetrics**  
**Ginecología, Obstetricia**  
**Ginecologia, Ostetricia**



Scheidenspekula  
Vaginal Specula  
Espéculos vaginales  
Speculi vaginali

für Kinder  
for children  
para niños  
per bambini



**COLLIN**  
65 x 10 mm  
GO-1134-00

für Jungfrauen  
for virgins  
para virgenes  
per vergini



**COLLIN**  
65 x 10 mm  
GO-1134-00



**COLLIN**

85 x 30 mm	GO-1130-01
100 x 35 mm	GO-1130-02
110 x 40 mm	GO-1130-03



**CUSCO**

80 x 24 mm	GO-1142-01
80 x 32 mm	GO-1142-02
98 x 16 mm	GO-1142-03
105 x 25 mm	GO-1142-04
107 x 29 mm	GO-1142-05
115 x 35 mm	GO-1142-06

Scheidenspekula  
Vaginal Specula  
Espéculos vaginales  
Speculi vaginali

zentrale Stellschraube  
central fi xation screw  
tornillo de sujeto central  
vite di regolazione centrale



**CUSCO**

75 x 32 mm	<b>GO-1144-01</b>
85 x 36 mm	<b>GO-1144-02</b>
95 x 37 mm	<b>GO-1144-03</b>

seitliche Stellschraube  
lateral fi xation screw  
tornillo de sujeto lateral  
vite di regolazione laterale



für Jungfrauen  
for virgins  
para virgenes  
per vergini

**CUSCO**

75 x 17 mm  
**GO-1140-00**

seitliche Stellschraube  
lateral fi xation screw  
tornillo de sujeto lateral  
vite di regolazione laterale



**CUSCO**

75 x 32 mm	<b>GO-1140-01</b>
85 x 35 mm	<b>GO-1140-02</b>
100 x 35 mm	<b>GO-1140-03</b>

Schweizer Modell  
Swiss pattern  
Modelo suizo  
Modello svizzero



**CUSCO**

90 x 23-25 mm	<b>GO-1146-01</b>
100 x 25-27 mm	<b>GO-1146-02</b>
110 x 27-30 mm	<b>GO-1146-03</b>



Scheidenspekula  
Vaginal Specula  
Espéculos vaginales  
Speculi vaginali



**GRAVE**

75 x 20 mm	GO-1100-01
95 x 35 mm	GO-1100-02
115 x 35 mm	GO-1100-03



**PEDERSON**

75 x 13 mm	GO-1120-01
100 x 22 mm	GO-1120-02
120 x 25 mm	GO-1120-03



**SEMM**

90 x 14-18 mm	GO-1150-01
100 x 17-20 mm	GO-1150-02
100 x 25-30 mm	GO-1150-03



**WEISSBARTH**

21,0 cm, 8 1/4"	GO-1160-00
-----------------	------------

Scheidenspekula  
Vaginal Specula  
Espéculos vaginales  
Speculi vaginali



mit abnehmbarem Gewicht  
with detachable weight  
con peso desmontable  
con peso smontabile

1,14 kg

**AUVARD**  
75 x 38 mm  
GO-1170-00



mit festem Gewicht  
with fixed weight  
con peso fi jo  
con peso fi sso

1,14 kg

**AUVARD**  
75 x 38 mm  
GO-1170-00



GO-1180-03

400 g

GO-1180-40

800 g

GO-1180-80

**SCHERBACK**  
GO-1180-00

koplett, complete, completo, completo



80 x 30 mm  
GO-1180-04

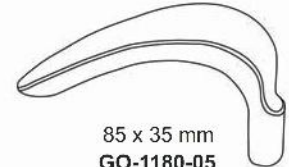

85 x 35 mm  
GO-1180-05

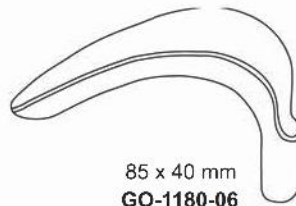

85 x 40 mm  
GO-1180-06



55 x 40-60 mm  
GO-1180-07

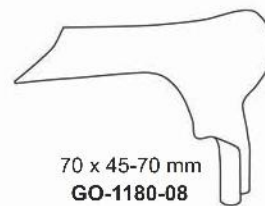

70 x 45-70 mm  
GO-1180-08

Scheidenspekula  
Vaginal Specula  
Espéculos vaginales  
Speculi vaginali



Satz  
Set  
Juego  
Set

**KRISTELLER**

Fig. 1 **GO-1220-01**  
Fig. 2 **GO-1220-02**  
Fig. 3 **GO-1220-03**



Spekula allein, fl ach  
Specula only, fl at hollow  
Espéculos suelto, con huecos planos  
Solo speculi, piatta

**KRISTELLER**

105 x 26 mm **GO-1221-01**  
105 x 28 mm **GO-1221-02**  
105 x 33 mm **GO-1221-03**



Halter allein  
Retractors only  
Valvas suelto  
Solo valve

**KRISTELLER**

115 x 22 mm **GO-1222-01**  
115 x 24 mm **GO-1222-02**  
115 x 29 mm **GO-1222-03**



Satz  
Set  
Juego  
Set

**KRISTELLER**

Fig. 1 **GO-1230-01**  
Fig. 2 **GO-1230-02**  
Fig. 3 **GO-1230-03**

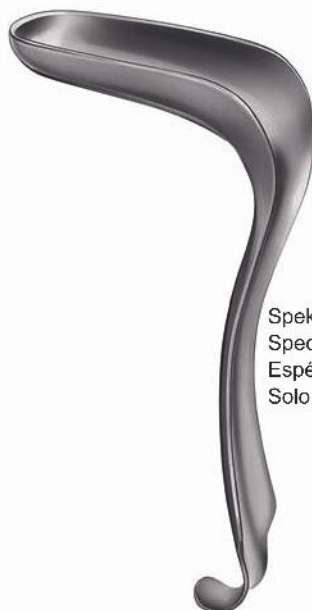

Spekula allein, fl ach  
Specula only, fl at hollow  
Espéculos suelto, con huecos planos  
Solo speculi, piatta

**KRISTELLER**

110 x 27 mm **GO-1231-01**  
110 x 30 mm **GO-1231-02**  
110 x 36 mm **GO-1231-03**

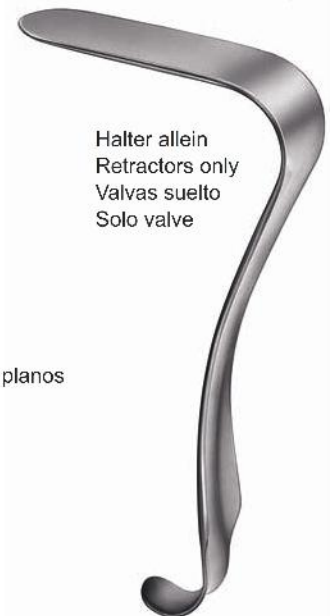

Halter allein  
Retractors only  
Valvas suelto  
Solo valve

**KRISTELLER**

115 x 23 mm **GO-1232-01**  
115 x 26 mm **GO-1232-02**  
115 x 32 mm **GO-1232-03**

Scheidenspekula  
Vaginal Specula  
Espéculos vaginales  
Speculi vaginali



Satz  
Set  
Juego  
Set

**KRISTELLER**

Fig. 0 **GO-234-00**  
Fig. 1 **GO-234-01**  
Fig. 2 **GO-234-02**  
Fig. 3 **GO-234-03**



Spekula allein  
Specula only  
Espéculos suelto  
Solo speculi

**KRISTELLER**

70 x 15 mm **GO-235-00**  
70 x 27 mm **GO-235-01**  
80 x 30 mm **GO-235-02**  
90 x 36 mm **GO-235-03**

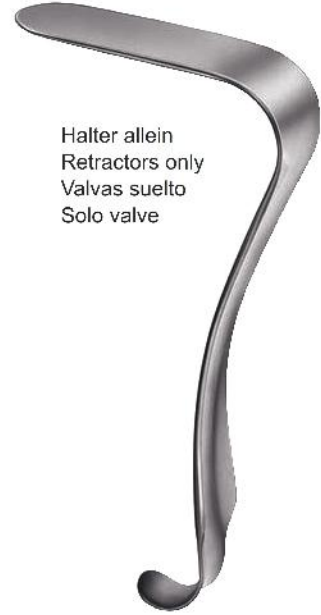

Halter allein  
Retractors only  
Valvas suelto  
Solo valve

**KRISTELLER**

75 x 10 mm **GO-236-00**  
75 x 23 mm **GO-236-01**  
85 x 26 mm **GO-236-02**  
100 x 32 mm **GO-236-03**

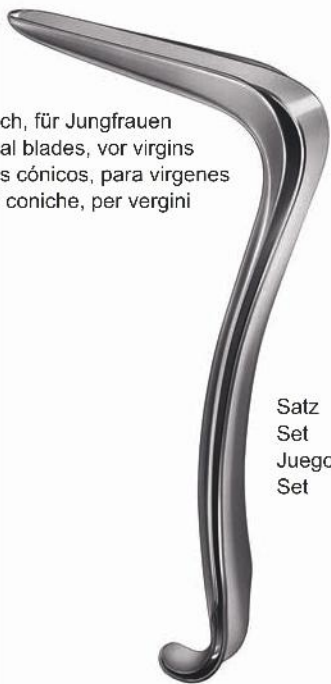

konisch, für Jungfrauen  
conical blades, vor virgins  
valvos cónicos, para virgenes  
valve coniche, per vergini

Satz  
Set  
Juego  
Set

**KRISTELLER**

Fig. 00 **GO-237-01**  
Fig. 0 **GO-237-02**



Spekula allein  
Specula only  
Espéculos suelto  
Solo speculi

**KRISTELLER**

105 x 18 mm **GO-238-01**  
105 x 21 mm **GO-238-02**



Halter allein  
Retractors only  
Valvas suelto  
Solo valve

**KRISTELLER**

110 x 14 mm **GO-239-01**  
110 x 17 mm **GO-239-02**

Scheidenspekula  
Vaginal Specula  
Espéculos vaginales  
Speculi vaginali



cht hohl  
ghtly-concave  
eremente concavos  
geremente concavi

Fig	a x b	
1	55 x 35 mm	GO-1260-01
2	85 x 35 mm	GO-1260-02
3	115 x 35 mm	GO-1260-03
1	55 x 45 mm	GO-1261-01
2	85 x 45 mm	GO-1261-02
3	115 x 45 mm	GO-1261-03
4	160 x 45 mm	GO-1261-04
1	55 x 60 mm	GO-1262-01
2	85 x 60 mm	GO-1262-02
3	115 x 60 mm	GO-1262-03
4	160 x 60 mm	GO-1262-04

**DOYEN**  
23,0 cm, 9"

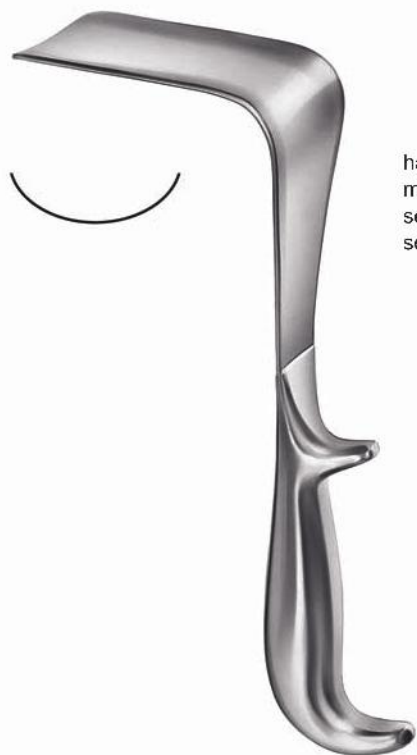

halb-hohl  
medium-concave  
semi-concavos  
semi-concavi

Fig	a x b	
1	55 x 35 mm	GO-1264-01
2	85 x 35 mm	GO-1264-02
3	115 x 35 mm	GO-1264-03
1	55 x 45 mm	GO-1265-01
2	85 x 45 mm	GO-1265-02
3	115 x 45 mm	GO-1265-03
1	55 x 60 mm	GO-1266-01
2	85 x 60 mm	GO-1266-02
3	115 x 60 mm	GO-1266-03

**DOYEN**  
23,0 cm, 9"

Scheidenspekula  
Vaginal Specula  
Espéculos vaginales  
Speculi vaginali



Satz  
Set  
Juego  
Set

**KALLMORGEN**  
70 x 40 mm GO-1270-01  
90 x 40 mm GO-1270-02



Spekula allein  
Specula only  
Espéculos suelto  
Solo speculi

**KALLMORGEN**  
70 x 40 mm GO-1271-01  
90 x 40 mm GO-1271-02



Halter allein  
Retractors only  
Valvas suelto  
Solo valve

**KALLMORGEN**  
70 x 40 mm GO-1272-01  
90 x 40 mm GO-1272-02



70 x 15 mm

**KRISTELLER**  
17,0 cm, 6<sup>3</sup>/<sub>4</sub>"  
GO-1275-17



75 x 39 mm

**KALLMORGEN**  
17,0 cm, 6<sup>3</sup>/<sub>4</sub>"  
GO-1290-17



**JACKSON**  
75 x 38 mm GO-1290-01  
90 x 38 mm GO-1290-02  
100 x 38 mm GO-1290-03

Scheidenspekula  
Vaginal Specula  
Espéculos vaginales  
Speculi vaginali



**BREISKY**  
14,0 cm, 5½"  
GO-1292-01



**BREISKY**  
14,0 cm, 5½"  
GO-1292-02



**BREISKY**  
17,0 cm, 6¾"  
GO-1292-03



**BREISKY**  
17,0 cm, 6¾"  
GO-1292-04

Scheidenspekula und -halter  
Vaginal Specula and Retractors  
Espéculos y valvas vaginales  
Speculi e valve vaginali

**SIMS**  
**GO-1294-00**  
Satz, Set, Juego, Set



**SIMS**  
12,5 cm, 5"  
**GO-1294-01**



**SIMS**  
15,0 cm, 6"  
**GO-1294-02**



**SIMS**  
17,5 cm, 7"  
**GO-1294-03**



**MATHIEU**  
100 x 13-23 mm **GO-1300-01**  
100 x 16-30 mm **GO-1300-02**



**MATHIEU**  
100 x 11-21 mm **GO-1301-01**  
100 x 14-27 mm **GO-1301-02**



**LANDAU**  
100 x 28 mm **GO-1305-01**  
100 x 38 mm **GO-1305-02**



Scheidenspekula  
Vaginal Specula  
Espéculos vaginales  
Speculi vaginali



100 x 20 mm	GO-1307-20
100 x 25 mm	GO-1307-25
100 x 30 mm	GO-1307-30
100 x 35 mm	GO-1307-35
100 x 40 mm	GO-1307-40
<hr/>	
130 x 20 mm	GO-1308-20
130 x 25 mm	GO-1308-25
130 x 30 mm	GO-1308-30
130 x 35 mm	GO-1308-35
130 x 40 mm	GO-1308-40
<hr/>	
155 x 40 mm	GO-1309-40

**BREISKY**

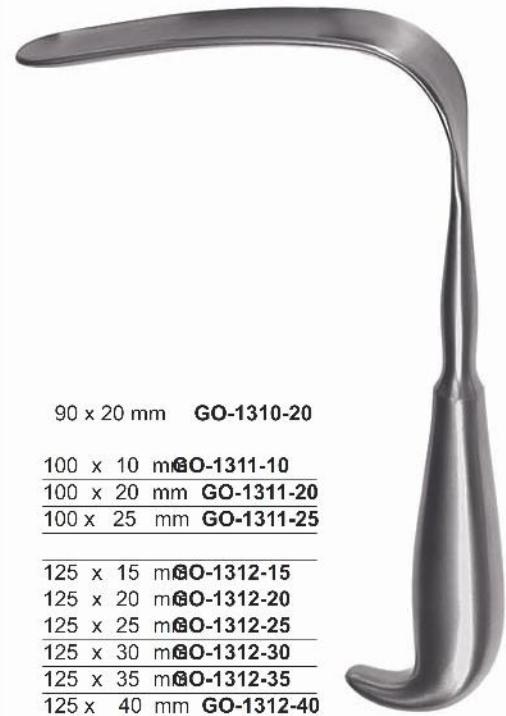

90 x 20 mm	GO-1310-20
<hr/>	
100 x 10 mm	GO-1311-10
100 x 20 mm	GO-1311-20
100 x 25 mm	GO-1311-25
<hr/>	
125 x 15 mm	GO-1312-15
125 x 20 mm	GO-1312-20
125 x 25 mm	GO-1312-25
125 x 30 mm	GO-1312-30
125 x 35 mm	GO-1312-35
125 x 40 mm	GO-1312-40

**MATZENAUER**



85 x 17 mm

**BRAUN, MODIF.**  
19,0 cm, 7 1/2"  
GO-1313-19



60 x 30 mm

**DOYEN**  
23,0 cm, 9"  
GO-1315-23



80 x 30 mm

**DOYEN**  
25,0 cm, 9"  
GO-1315-25



95 x 38 mm

**WERTHEIM**  
30,0 cm, 12"  
GO-1317-30

Endospekula, Lateral-Spekulum, Intrauterinsonde  
Endospecula, Lateral Speculum, Intrauterine Probe  
Endoespéculos, Espéculo lateral, Sonda intra-uterina  
Endospeculi, Speculo lateral, Sonde intrauterine

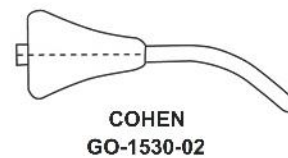
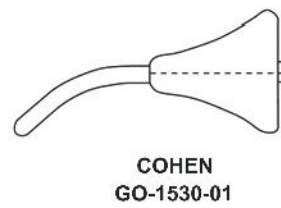
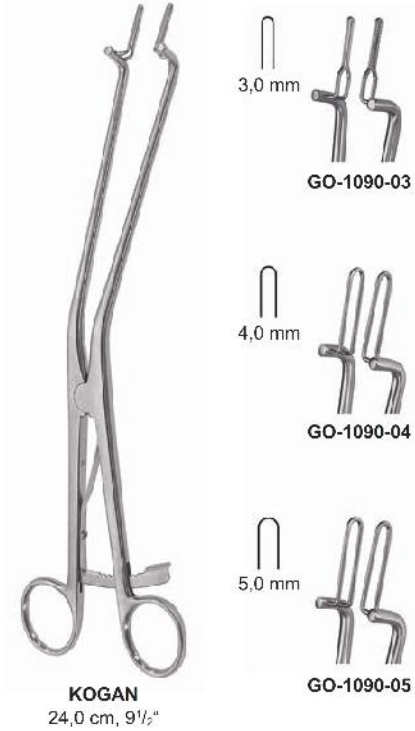
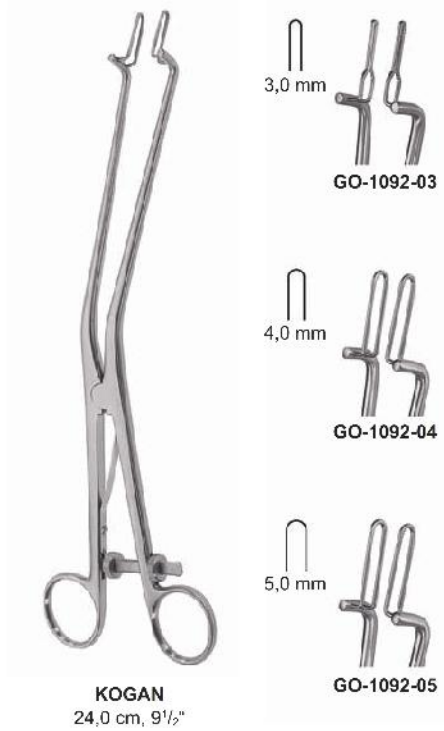

Uterus-Dilatatoren  
Uterine Dilators  
Dilatadores uterinos  
Dilatatori uterini



**HEGAR**  
18,5 cm, 7 1/4"

Ø 1,0 mm	<b>GO-1350-01</b>
Ø 2,0 mm	<b>GO-1350-02</b>
Ø 3,0 mm	<b>GO-1350-03</b>
Ø 4,0 mm	<b>GO-1350-04</b>
Ø 5,0 mm	<b>GO-1350-05</b>
Ø 6,0 mm	<b>GO-1350-06</b>
Ø 7,0 mm	<b>GO-1350-07</b>
Ø 8,0 mm	<b>GO-1350-08</b>
Ø 9,0 mm	<b>GO-1350-09</b>
Ø 10,0 mm	<b>GO-1350-10</b>
Ø 11,0 mm	<b>GO-1350-11</b>
Ø 12,0 mm	<b>GO-1350-12</b>
Ø 13,0 mm	<b>GO-1350-13</b>
Ø 14,0 mm	<b>GO-1350-14</b>
Ø 15,0 mm	<b>GO-1350-15</b>
Ø 16,0 mm	<b>GO-1350-16</b>
Ø 17,0 mm	<b>GO-1350-17</b>
Ø 18,0 mm	<b>GO-1350-18</b>
Ø 19,0 mm	<b>GO-1350-19</b>
Ø 20,0 mm	<b>GO-1350-20</b>
Ø 21,0 mm	<b>GO-1350-21</b>
Ø 22,0 mm	<b>GO-1350-22</b>
Ø 23,0 mm	<b>GO-1350-23</b>
Ø 24,0 mm	<b>GO-1350-24</b>
Ø 25,0 mm	<b>GO-1350-25</b>
Ø 26,0 mm	<b>GO-1350-26</b>



**HEGAR**  
18,5 cm, 7 1/4"

Ø 1,5 mm	<b>GO-1351-01</b>
Ø 2,5 mm	<b>GO-1351-02</b>
Ø 3,5 mm	<b>GO-1351-03</b>
Ø 4,5 mm	<b>GO-1351-04</b>
Ø 5,5 mm	<b>GO-1351-05</b>
Ø 6,5 mm	<b>GO-1351-06</b>
Ø 7,5 mm	<b>GO-1351-07</b>
Ø 8,5 mm	<b>GO-1351-08</b>
Ø 9,5 mm	<b>GO-1351-09</b>
Ø 10,5 mm	<b>GO-1351-10</b>
Ø 11,5 mm	<b>GO-1351-11</b>
Ø 12,5 mm	<b>GO-1351-12</b>
Ø 13,5 mm	<b>GO-1351-13</b>
Ø 14,5 mm	<b>GO-1351-14</b>
Ø 15,5 mm	<b>GO-1351-15</b>
Ø 16,5 mm	<b>GO-1351-16</b>
Ø 17,5 mm	<b>057-1351-17</b>



205 x 105 x 45 mm

**HEGAR**  
**GO-1350-99**  
Satz, Set, Juego, Set  
Ø 1,0 - Ø 26,0  
(26 dilators)

**HEGAR**  
**GO-1350-98**  
Satz, Set, Juego, Set  
Ø 4,0 - Ø 17,0  
(14 dilators)

Uterus-Dilatatoren  
Uterine Dilators  
Dilatadores uterinos  
Dilatatori uterini



**HEGAR**  
20,0 cm, 8"

1,0 / 2,0 mm	<b>GO-1354-01</b>
Ø 3,0 / 4,0 mm	<b>GO-1354-03</b>
Ø 5,0 / 6,0 mm	<b>GO-1354-05</b>
Ø 7,0 / 8,0 mm	<b>GO-1354-07</b>
Ø 9,0 / 10,0 mm	<b>GO-1354-09</b>
Ø 11,0 / 12,0 mm	<b>GO-1354-11</b>
Ø 13,0 / 14,0 mm	<b>GO-1354-13</b>
Ø 15,0 / 16,0 mm	<b>GO-1354-15</b>
Ø 17,0 / 18,0 mm	<b>GO-1354-17</b>
Ø 19,0 / 20,0 mm	<b>GO-1354-19</b>
Ø 21,0 / 22,0 mm	<b>GO-1354-21</b>
Ø 23,0 / 24,0 mm	<b>GO-1354-23</b>
Ø 25,0 / 26,0 mm	<b>GO-1354-25</b>



**HEGAR**  
**GO-1354-98**  
Satz, Set, Juego, Set  
Ø 3,0 / 4,0 - Ø 17,0 / 18,0 mm  
(8 dilators)

**HEGAR**  
**GO-1354-99**  
Satz, Set, Juego, Set  
Ø 1,0 / 2,0 - Ø 25,0 / 26,0 mm  
(13 dilators)



**HANK**

Ø 4,5 / 5,0 mm	<b>GO-1360-05</b>
Ø 5,5 / 6,0 mm	<b>GO-1360-06</b>
Ø 6,5 / 7,0 mm	<b>GO-1360-07</b>
Ø 7,5 / 8,0 mm	<b>GO-1360-08</b>
Ø 8,5 / 9,0 mm	<b>GO-1360-09</b>
Ø 9,5 / 10,0 mm	<b>GO-1360-10</b>



**HANK**  
**GO-1360-98**  
Satz, Set, Juego, Set  
Ø 4,5 / 5,0 - Ø 9,5 / 10,0 mm  
(6 dilators)

Uterus-Dilatatoren, Hakenzangen  
 Uterine Dilators, Uterine Tenaculum Forceps  
 Dilatadores uterinos, Pinzas para coger el cuello del útero  
 Dilatatori uterini, Pinze per abbassare il collo dell'utero



PRATT

4,5 / 5,0 mm	GO-1370-05
5,5 / 6,0 mm	GO-1370-06
7,5 / 8,0 mm	GO-1370-08
8,5 / 9,0 mm	GO-1370-09
9,5 / 10,0 mm	GO-1370-10
11,5 / 12,0 mm	GO-1370-12
12,5 / 13,0 mm	GO-1370-13
13,5 / 14,0 mm	GO-1370-14



**PRATT**  
**GO-1370-98**  
 Satz, Set, Juego, Set  
 Ø 4,5 / 5,0 - Ø 13,5 / 14,0 mm  
 (8 dilators)



**BARRETT**  
 18,0 cm, 7"  
 GO-1410-18

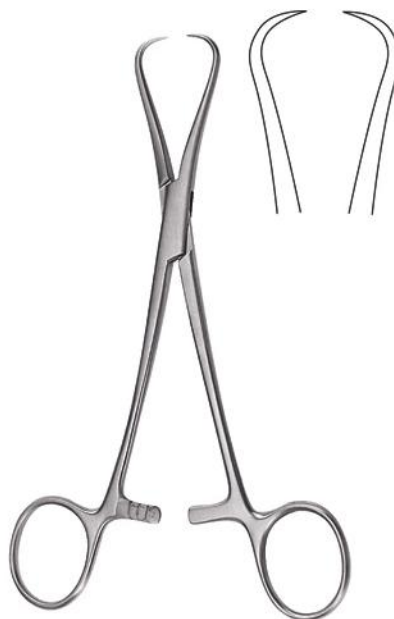

**ADAIR**  
 19,0 cm, 7½"  
 GO-1412-19



**STAUDE-MOORE**  
 17,0 cm, 6¾"  
 GO-1414-17

Hakenzangen  
Uterine Tenaculum Forceps  
Pinzas para coger el cuello del útero  
Pinze per abbassare il collo dell'utero

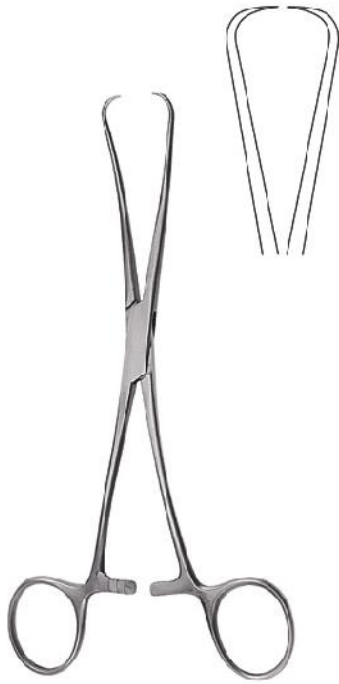

**JARCHO**  
20,0 cm, 8"  
GO-1417-20



**SCHROEDER**  
25,0 cm, 9<sup>3</sup>/<sub>4</sub>"  
GO-1400-25



**BRAUN**  
25,0 cm, 9<sup>3</sup>/<sub>4</sub>"  
GO-1404-25



**DUPLAY**  
28,0 cm, 11"  
GO-1419-28



**POZZI**  
26,0 cm, 10<sup>1</sup>/<sub>4</sub>"  
GO-1402-26



**KAHN**  
24,0 cm, 9<sup>1</sup>/<sub>2</sub>"  
GO-1421-24

Hakenzangen  
 Uterine Tenaculum Forceps  
 Pinzas para coger el cuello del útero  
 Pinze per abbassare il collo dell'utero



**SKENE**  
 24,0 cm, 9 1/2"  
 GO-1423-24



**SCHROEDER**  
 24,0 cm, 9 1/2"  
 GO-1426-24



**SCHROEDER**  
 24,0 cm, 9 1/2"  
 GO-1429-24



**TEALE**  
 23,0 cm, 9"  
 GO-1431-23



**JACOBS**  
 21,0 cm, 8 1/2"  
 GO-1434-21



**JACOBS**  
 21,0 cm, 8 1/2"  
 GO-1435-21

**Hakenzangen**  
**Uterine Tenaculum Forceps**  
**Pinzas para coger el cuello del útero**  
**Pinze per abbassare il collo dell'utero**



**MUSEUX**  
24,0 cm, 9 1/2"



**MUSEUX**  
24,0 cm, 9 1/2"



**BRAUN**  
15,5 cm, 6"  
GO-1442-15



**CZERNY**  
20,5 cm, 8"  
GO-1444-20

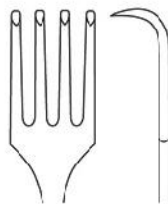

**PRATT**  
28,0 cm, 11"  
GO-1446-28

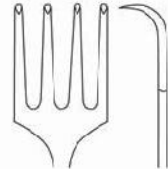

**IOWA**  
26,0 cm, 10 1/4"  
GO-1449-26





Polypen- und Ovarienzangen, Uterusfaßzangen  
 Polypus and Ovum Forceps, Uterine Elevating Forceps  
 Pinzas para pólipos uterinos y ovarios, Pinzas para la útero  
 Pinze per polipi e ovaie, Pinze per affarrare l'utero



**DOYEN**  
20,5 cm, 8"  
GO-1470-20

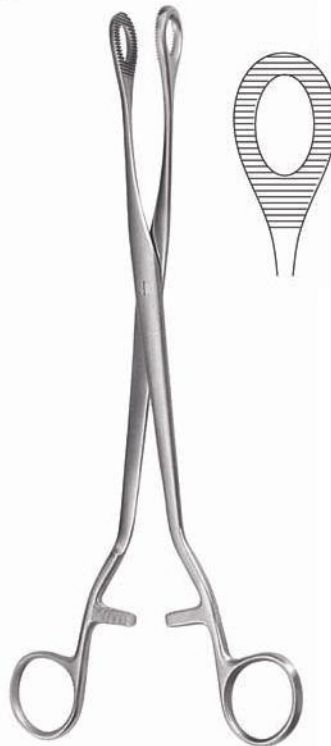

**NOTO**  
27,0 cm, 10<sup>5</sup>/<sub>8</sub>"  
GO-1472-27

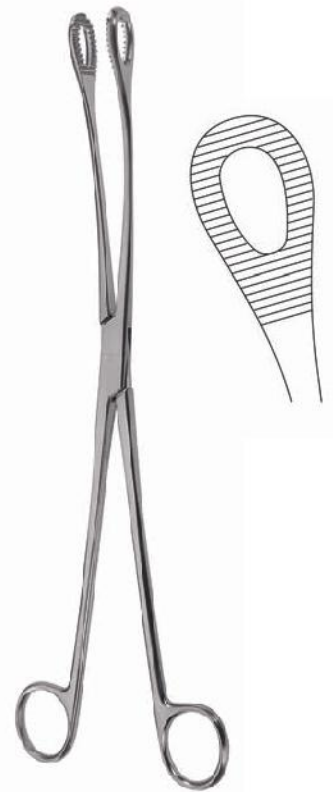

**KELLY**  
32,0 cm, 12<sup>1</sup>/<sub>2</sub>"  
GO-1475-32



**HEYWOOD-SMITH**  
25,0 cm, 9<sup>3</sup>/<sub>4</sub>"  
GO-1480-25



**DARTIGUES**  
27,0 cm, 10<sup>3</sup>/<sub>4</sub>"  
GO-1482-27



**SOMER**  
23,0 cm, 9"  
GO-1485-23

Uterusfaßzangen, Uterussonden, Zentimetereinteilung  
 Uterine Elevating Forceps, Uterine Probes, graduated in centimeters  
 Pinzas para la útero, Histerómetros, graduado en centímetros  
 Pinze per afferrare l'utero, Isterometri, graduato in cm



**COLLIN**  
 25,0 cm, 9<sup>3</sup>/<sub>4</sub>"  
 GO-1488-25



**BEACHAM**  
 26,0 cm, 10<sup>1</sup>/<sub>4</sub>"  
 GO-1500-26

Amniotom  
 Amniotome  
 Amniótomo  
 Amniotomo



**BRAUN**  
 28,0 cm, 11"  
 GO-1502-28

Uterus-Depressor  
 Uterine depressor  
 Depresor uterino  
 Depressori uterini



**SIMS**  
 32,0 cm, 12<sup>1</sup>/<sub>2</sub>"  
 GO-1510-32



**SIMS**  
 32,0 cm, 12<sup>1</sup>/<sub>2</sub>"  
 GO-1511-32

biegsam  
 malleable  
 maleable  
 malleabile



**MARTIN**  
 32,0 cm, 12<sup>1</sup>/<sub>2</sub>"  
 GO-1516-32



**MARTIN**  
 32,0 cm, 12<sup>1</sup>/<sub>2</sub>"  
 GO-1518-32

biegsam  
 malleable  
 maleable  
 malleabile



**VALLEIX**  
 25,0 cm, 10"  
 GO-1521-25

Ø 4 mm

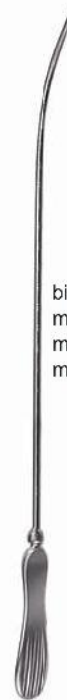

**SIMPSON**  
 29,0 cm, 11<sup>1</sup>/<sub>2</sub>"  
 GO-1527-29

biegsam  
 malleable  
 maleable  
 malleabile

Ø 4 mm



**COLLIN**  
 28,0 cm, 11"  
 GO-1529-28

Biopsieküretten  
Biopsy Curettes  
Curetas para biopsia  
Curette per biopsia



**KEVORKIAN**  
30,0 cm, 12"  
GO-1540-30



**KEVORKIAN**  
30,0 cm, 12"  
GO-1542-30



**KEVORKIAN**  
30,0 cm, 12"  
GO-1543-30

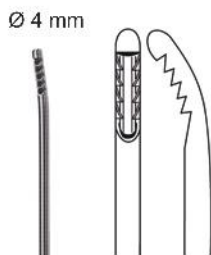

**NOVAK**  
23,0 cm, 9"  
GO-1550-04

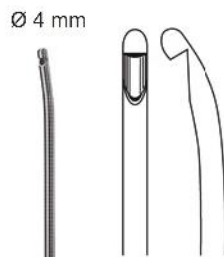

**RANDALL**  
23,0 cm, 9"  
GO-1552-04



**MILAN**  
29,0 cm, 11 1/2"



Myominstrumente  
Myoma Instruments  
Instrumentos para mioma  
Strumenti per fibroma



**UTERUSPERFORATOR**  
25,0 cm, 9<sup>3</sup>/<sub>4</sub>"  
GO-1570-25



**FISTELHAKEN**  
25,0 cm, 9<sup>3</sup>/<sub>4</sub>"  
GO-1572-25



**SIMON**  
22,0 cm, 8<sup>5</sup>/<sub>8</sub>"  
GO-1574-22



**EMMETT**  
22,0 cm, 8<sup>5</sup>/<sub>8</sub>"



GO-1576-01



GO-1576-02



GO-1576-03



v-1576-04



GO-1576-05



**SEGOND**  
27,0 cm, 10<sup>5</sup>/<sub>8</sub>"  
GO-1580-27

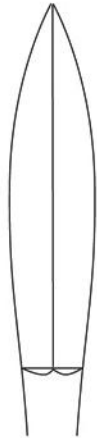

**AYRE**  
23,0 cm, 9"  
GO-1583-23

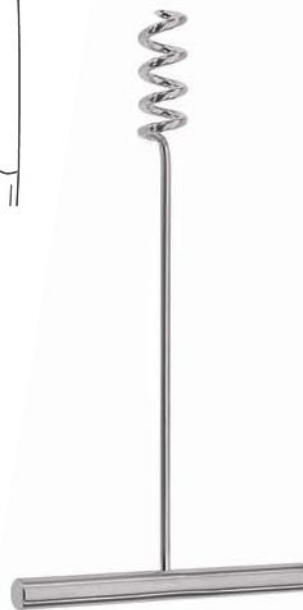
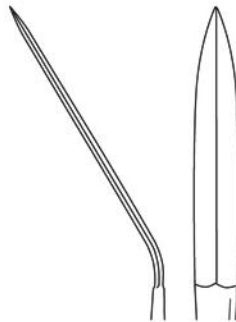

**DOYEN**  
19,0 cm, 7<sup>1</sup>/<sub>2</sub>"  
GO-1588-01



**DOYEN**  
17,0 cm, 6<sup>3</sup>/<sub>4</sub>"  
GO-1588-02

**Uterusküretten**  
**Uterine Curettes**



5 mm  
Fig. 00



6 mm  
Fig. 0



7 mm  
Fig. 1



8 mm  
Fig. 2



9 mm  
Fig. 3



11 mm  
Fig. 4



12 mm  
Fig. 5



14 mm  
Fig. 6



15 mm  
Fig. 7



16 mm  
Fig. 8



19 mm  
Fig. 9



20 mm  
Fig. 10



21 mm  
Fig. 11



23 mm  
Fig. 12



scharf, fest  
sharp, rigid  
cortantes, rígidas  
acute, rigide

Fig. 00	GO-1700-05
Fig. 0	GO-1700-06
Fig. 1	GO-1700-07
Fig. 2	GO-1700-08
Fig. 3	GO-1700-09
Fig. 4	GO-1700-11
Fig. 5	GO-1700-12
Fig. 6	GO-1700-14
Fig. 7	GO-1700-15
Fig. 8	GO-1700-16
Fig. 9	GO-1700-19
Fig. 10	GO-1700-20
Fig. 11	GO-1700-21
Fig. 12	GO-1700-23

**RECAMIER**  
26,0 cm, 10 1/4"



scharf, biegsam  
sharp, malleable  
cortantes, maleable  
acute, malleabile

Fig. 00	GO-1701-05
Fig. 0	GO-1701-06
Fig. 1	GO-1701-07
Fig. 2	GO-1701-08
Fig. 3	GO-1701-09
Fig. 4	GO-1701-11
Fig. 5	GO-1701-12
Fig. 6	GO-1701-14
Fig. 7	GO-1701-15
Fig. 8	GO-1701-16
Fig. 9	GO-1701-19
Fig. 10	GO-1701-20
Fig. 11	GO-1701-21
Fig. 12	GO-1701-23

**RECAMIER**  
26,0 cm, 10 1/4"

Uterusküretten  
 Uterine Curettes  
 Curetas uterinas  
 Curette uterine

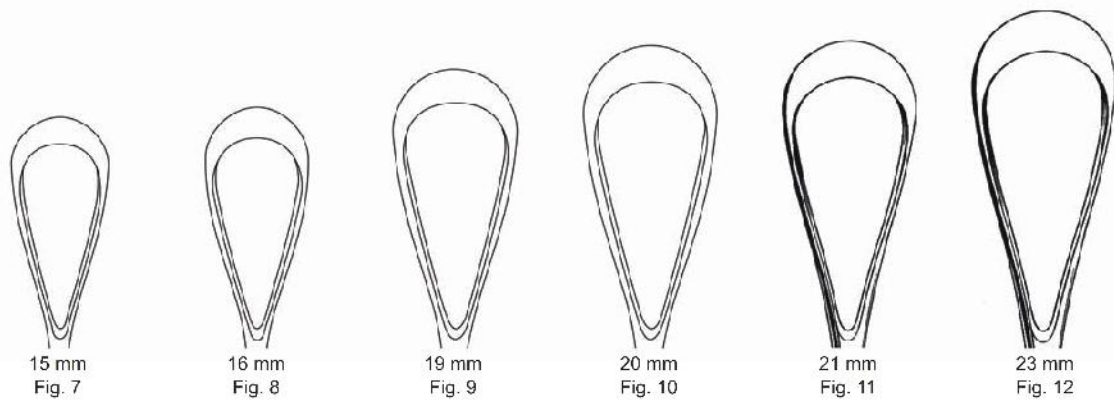
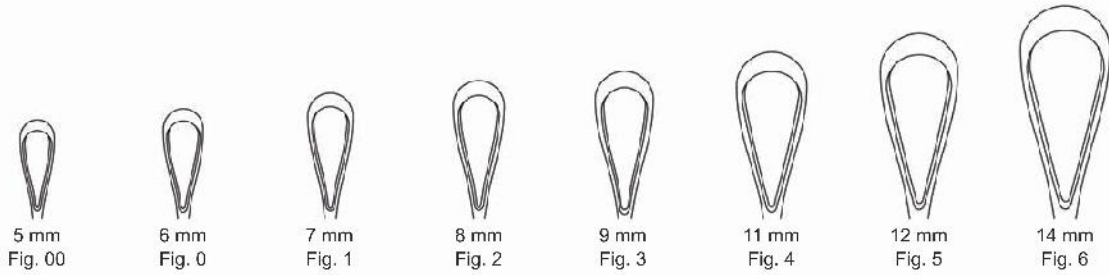

scharf, fest  
 sharp, rigid  
 cortantes, rígidas  
 acute, rigide

Fig. 00	GO-1702-05
Fig. 0	GO-1702-06
Fig. 1	GO-1702-07
Fig. 2	GO-1702-08
Fig. 3	GO-1702-09
Fig. 4	GO-1702-11
Fig. 5	GO-1702-12
Fig. 6	GO-1702-14
Fig. 7	GO-1702-15
Fig. 8	GO-1702-16
Fig. 9	GO-1702-19
Fig. 10	GO-1702-20
Fig. 11	GO-1702-21
Fig. 12	GO-1702-23

**SIMS**  
 26,0 cm, 10<sup>1</sup>/<sub>4</sub>"



scharf, biegsam  
 sharp, malleable  
 cortantes, maleable  
 acute, malleabile

Fig. 00	GO-1703-05
Fig. 0	GO-1703-06
Fig. 1	GO-1703-07
Fig. 2	GO-1703-08
Fig. 3	GO-1703-09
Fig. 4	GO-1703-11
Fig. 5	GO-1703-12
Fig. 6	GO-1703-14
Fig. 7	GO-1703-15
Fig. 8	GO-1703-16
Fig. 9	GO-1703-19
Fig. 10	GO-1703-20
Fig. 11	GO-1703-21
Fig. 12	GO-1703-23

**SIMS**  
 26,0 cm, 10<sup>1</sup>/<sub>4</sub>"

Uterusküretten  
 Uterine Curettes  
 Curetas uterinas  
 Curette uterine



5 mm  
Fig. 00



6 mm  
Fig. 0



7 mm  
Fig. 1



8 mm  
Fig. 2



9 mm  
Fig. 3



11 mm  
Fig. 4



12 mm  
Fig. 5



14 mm  
Fig. 6



15 mm  
Fig. 7



16 mm  
Fig. 8



19 mm  
Fig. 9



20 mm  
Fig. 10



21 mm  
Fig. 11



23 mm  
Fig. 12



scharf, fest  
 sharp, rigid  
 cortantes, rígidas  
 acute, rigide

Fig. 00	GO-1710-05
Fig. 0	GO-1710-06
Fig. 1	GO-1710-07
Fig. 2	GO-1710-08
Fig. 3	GO-1710-09
Fig. 4	GO-1710-11
Fig. 5	GO-1710-12
Fig. 6	GO-1710-14
Fig. 7	GO-1710-15
Fig. 8	GO-1710-16
Fig. 9	GO-1710-19
Fig. 10	GO-1710-20
Fig. 11	GO-1710-21
Fig. 12	GO-1710-23

RECAMIER  
 31,0 cm, 12<sup>1</sup>/<sub>4</sub>"



scharf, biegsam  
 sharp, malleable  
 cortantes, maleable  
 acute, malleabile

Fig. 00	GO-1711-05
Fig. 0	GO-1711-06
Fig. 1	GO-1711-07
Fig. 2	GO-1711-08
Fig. 3	GO-1711-09
Fig. 4	GO-1711-11
Fig. 5	GO-1711-12
Fig. 6	GO-1711-14
Fig. 7	GO-1711-15
Fig. 8	GO-1711-16
Fig. 9	GO-1711-19
Fig. 10	GO-1711-20
Fig. 11	GO-1711-21
Fig. 12	GO-1711-23

RECAMIER  
 31,0 cm, 12<sup>1</sup>/<sub>4</sub>"

Uterusküretten  
Uterine Curettes  
Curettes uterinas  
Curette uterine

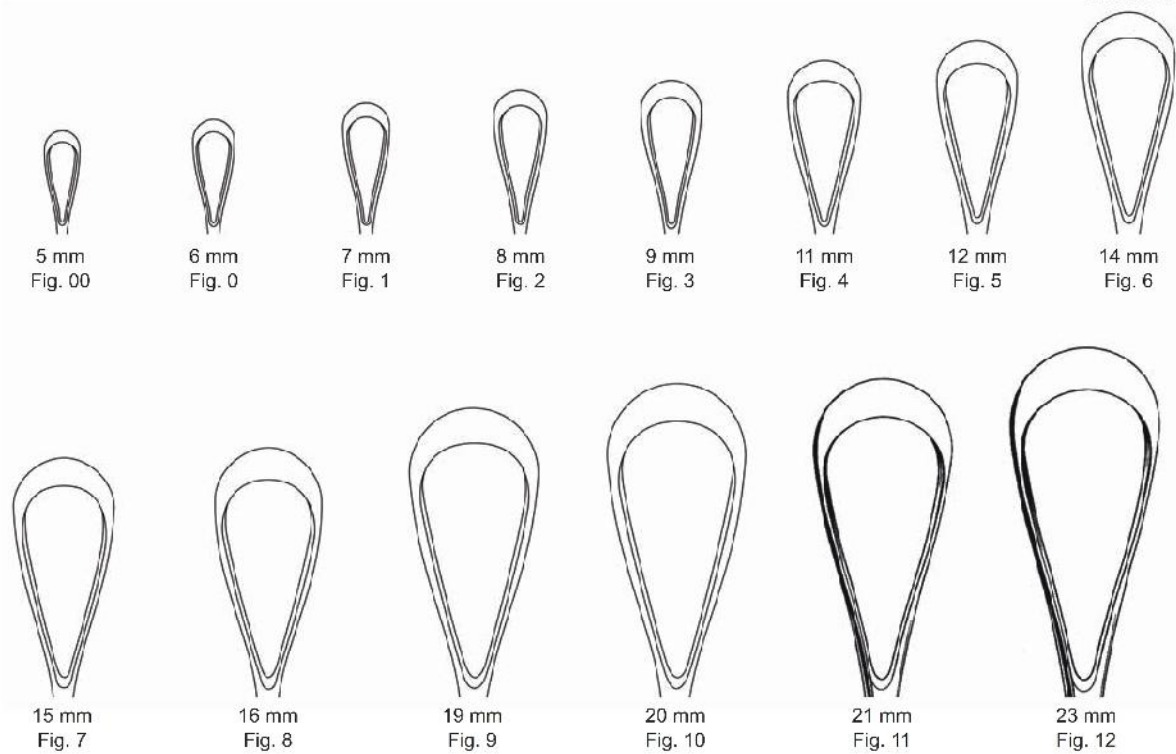

scharf, fest  
sharp, rigid  
cortantes, rígidas  
acute, rigide

Fig. 00	GO-1712-05
Fig. 0	GO-1712-06
Fig. 1	GO-1712-07
Fig. 2	GO-1712-08
Fig. 3	GO-1712-09
Fig. 4	GO-1712-11
Fig. 5	GO-1712-12
Fig. 6	GO-1712-14
Fig. 7	GO-1712-15
Fig. 8	GO-1712-16
Fig. 9	GO-1712-19
Fig. 10	GO-1712-20
Fig. 11	GO-1712-21
Fig. 12	GO-1712-23

**SIMS**  
31,0 cm, 12<sup>1</sup>/<sub>4</sub>"



scharf, biegsam  
sharp, malleable  
cortantes, maleable  
acute, malleabile

Fig. 00	GO-1713-05
Fig. 0	GO-1713-06
Fig. 1	GO-1713-07
Fig. 2	GO-1713-08
Fig. 3	GO-1713-09
Fig. 4	GO-1713-11
Fig. 5	GO-1713-12
Fig. 6	GO-1713-14
Fig. 7	GO-1713-15
Fig. 8	GO-1713-16
Fig. 9	GO-1713-19
Fig. 10	GO-1713-20
Fig. 11	GO-1713-21
Fig. 12	GO-1713-23

**SIMS**  
31,0 cm, 12<sup>1</sup>/<sub>4</sub>"



Uterusküretten  
 Uterine Curettes  
 Curetas uterinas  
 Curette uterine

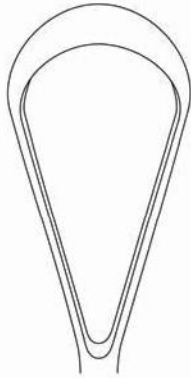

30 mm  
 Fig. 1

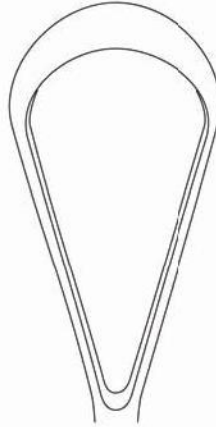

35 mm  
 Fig. 2

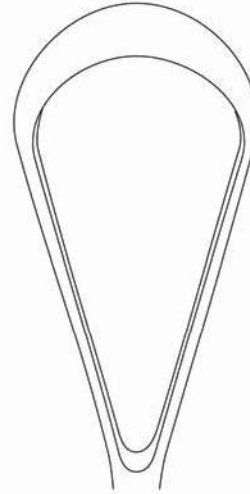

40 mm  
 Fig. 3



scharf, fest  
 sharp, rigid  
 cortantes, rigidas  
 acute, rigide

Fig. 1      **GO-1720-30**  
 Fig. 2      **GO-1720-35**  
 Fig. 3      **GO-1720-40**

**SIMS**  
 31,0 cm, 12<sup>1</sup>/<sub>4</sub>"



scharf, biegsam  
 sharp, malleable  
 cortantes, maleable  
 acute, malleabile

Fig. 1      **GO-1721-30**  
 Fig. 2      **GO-1721-35**  
 Fig. 3      **GO-1721-40**

**SIMS**  
 31,0 cm, 12<sup>1</sup>/<sub>4</sub>"

Uterusküretten  
Uterine Curettes  
Curetas uterinas  
Curette uterine

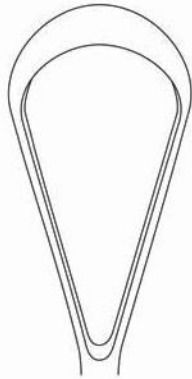

30 mm  
Fig. 1

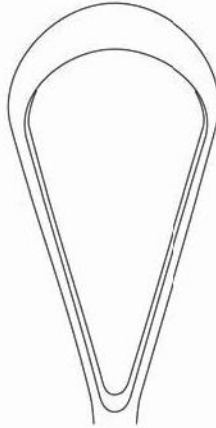

35 mm  
Fig. 2

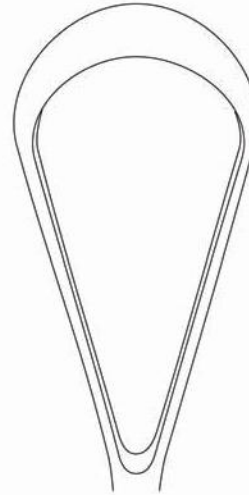

40 mm  
Fig. 3



scharf, fest  
sharp, rigid  
cortantes, rigidas  
acute, rigide

Fig. 1      **GO-1722-30**  
Fig. 2      **GO-1722-35**  
Fig. 3      **GO-1722-40**

**BUMM**  
31,0 cm, 12<sup>1</sup>/<sub>4</sub>"



scharf, biegsam  
sharp, malleable  
cortantes, maleable  
acute, malleabile

Fig. 1      **GO-1723-30**  
Fig. 2      **GO-1723-35**  
Fig. 3      **GO-1723-40**

**BUMM**  
31,0 cm, 12<sup>1</sup>/<sub>4</sub>"

Uteruslöffel, Uterus-Biopsiezangen  
 Uterine Scoopes, Cervical Biopsy and Specimen Forceps  
 Cucharillas uterinas, Pinzas saca-bocados para biopsia  
 Curette uterine, Pinze per la biopsia cervicale e da prelievo



**BLAKE**  
 27,0 cm, 10<sup>5</sup>/<sub>8</sub>"  
 GO-1750-27



**SIMON**  
 25,0 cm, 9<sup>3</sup>/<sub>4</sub>"

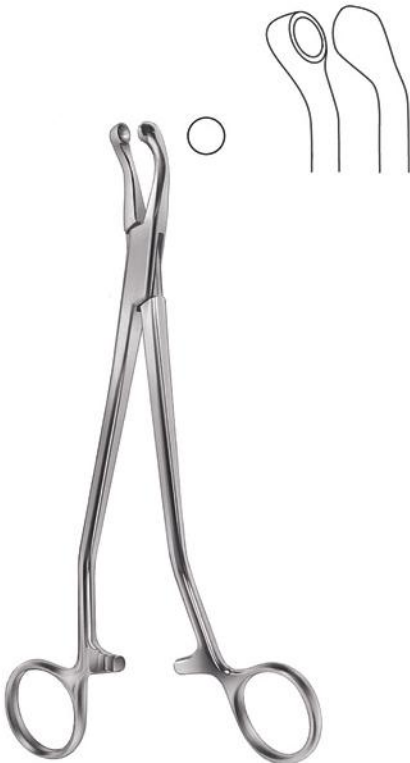
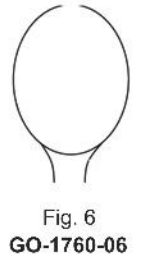
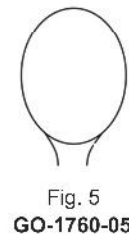
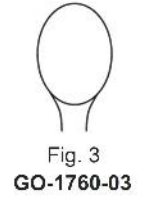
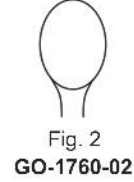
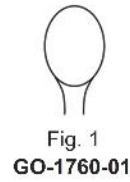

**THOMS-GAYLOR**  
 22,0 cm, 8<sup>5</sup>/<sub>8</sub>" GO-1680-22  
 24,0 cm, 9<sup>1</sup>/<sub>2</sub>" GO-1680-24



**SCHUBERT**  
 21,0 cm, 8<sup>1</sup>/<sub>4</sub>" GO-1682-21  
 29,0 cm, 11<sup>1</sup>/<sub>2</sub>" GO-1682-29



**SCHUMACHER-VAN DOREN**  
 24,0 cm, 9<sup>1</sup>/<sub>2</sub>"  
 GO-1684-24

Uterus-Biopsiezangen  
Cervical Biopsy and Specimen Forceps  
Pinzas saca-bocados para biopsia  
Pinze per la biopsia cervicale e da prelievo



**THOMS-GAYLOR**  
24,0 cm, 9 1/2"  
GO-1686-24



**FAURE**  
21,0 cm, 8 1/4"  
GO-1688-21



**SCHUBERT**  
26,0 cm, 10 1/4"  
GO-1690-26

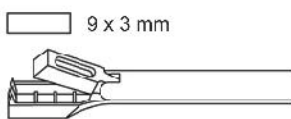

**KEVORKIAN**  
25,0 cm, 10"  
GO-1602-25

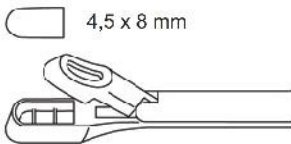

**EPPENDORFER**  
20,0 cm, 8"  
GO-1604-20

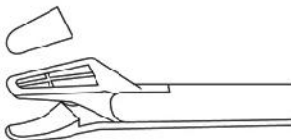

**ALEXANDER**  
28,0 cm, 11"  
GO-1608-28

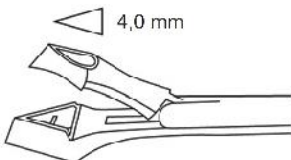

**SCHUMACHER**  
24,0 cm, 9 1/2"  
GO-1610-04

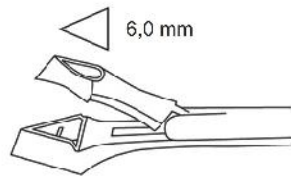

**SCHUMACHER**  
24,0 cm, 9 1/2"  
GO-1610-06

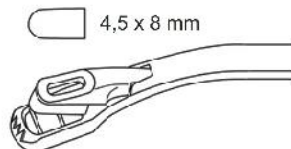

**WITTNER**  
23,0 cm, 9"  
GO-1615-23

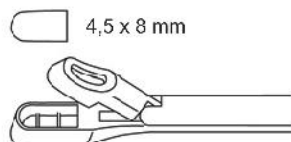

**WITTNER**  
23,0 cm, 9"  
GO-1614-23

Uterus-Biopsiezangen  
 Cervical Biopsy and Specimen Forceps  
 Pinzas saca-bocados para biopsia  
 Pinze per la biopsia cervicale e da prelievo

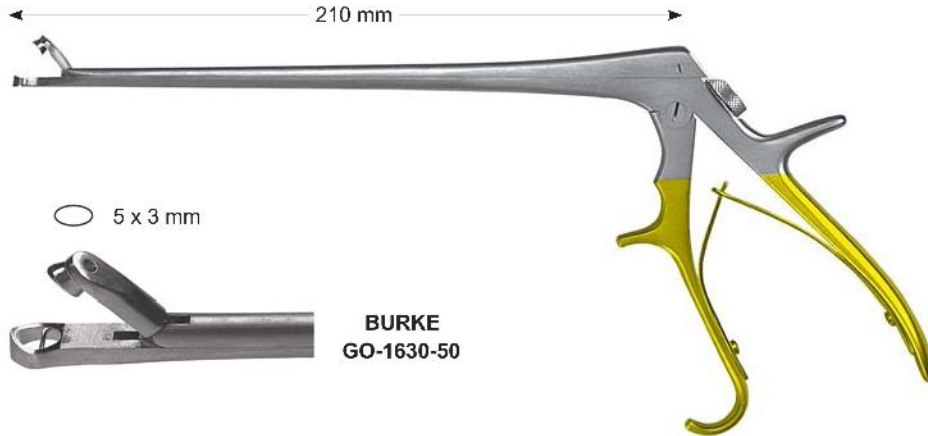

Geburtszangen  
Obstetrical Forceps  
Fórceps para obstétrica  
Forbici per ostetricia



**WRIGLEY**  
28,0 cm, 11"  
GO-1056-28



**SIMPSON**  
30,0 cm, 11<sup>3</sup>/<sub>4</sub>"  
GO-134-30



**SIMPSON-BRAUN**  
33,0 cm, 13"  
GO-136-33



**SIMPSON-BRAUN**  
36,0 cm, 14<sup>1</sup>/<sub>8</sub>"  
GO-1036-36



**SIMPSON-LUIKART**  
36,0 cm, 14<sup>1</sup>/<sub>8</sub>"  
GO-1046-36



**DE LEE**  
30,0 cm, 11<sup>3</sup>/<sub>4</sub>"  
GO-1058-30



**DE LEE**  
36,0 cm, 14<sup>1</sup>/<sub>8</sub>"  
GO-1058-36



**DE LEE**  
38,0 cm, 15<sup>3</sup>/<sub>8</sub>"  
GO-1058-38

Geburtszangen  
Obstetrical Forceps  
Fórceps para obstétrica  
Forbici per ostetricia



**MC LEAN**  
36,0 cm, 14<sup>1</sup>/<sub>8</sub>"  
058-1044-36



**KIELAND**  
41,0 cm, 16"  
GO-1052-41



**KIELAND-LUIKART**  
40,0 cm, 15<sup>3</sup>/<sub>4</sub>"  
GO-1054-40



**PIPER**  
44,0 cm, 17<sup>1</sup>/<sub>4</sub>"  
GO-1060-44



**ELLIOT**  
32,0 cm, 12<sup>1</sup>/<sub>2</sub>"  
058-1080-32



**ELLIOT**  
38,0 cm, 15"  
GO-1080-38



**NAEGELE**  
36,0 cm, 14<sup>1</sup>/<sub>8</sub>"  
GO-1084-36



**NAEGELE**  
40,0 cm, 15<sup>3</sup>/<sub>4</sub>"  
GO-1084-40

Geburtszangen, Plazentar- und Abortuszangen  
 Obstetrical Forceps, Placenta and Ovum Forceps  
 Fórceps para obstétrica, Pinzas para aborto y placenta  
 Forbici per ostetricia, Pinze per placenta e per ovaie



**GREEN-ARMYTAGE**  
 21,0 cm, 8 1/2"  
 058-1200-21



**PESTALOZZA**  
 30,0 cm, 11 3/4"  
 GO-1252-30



**SAENGER**  
 27,0 cm, 10 5/8"  
 GO-1260-27



**SAENGER**  
 27,0 cm, 10 5/8"  
 GO-1261-27



**WINTER**  
 28,0 cm, 11"



Fig. 1  
 GO-1244-01



Fig. 2  
 GO-1244-02



Fig. 3  
 GO-1244-03



Fig. 1  
 GO-1245-01



Fig. 2  
 GO-1245-02



Fig. 3  
 GO-1245-03



Plazentar- und Abortuszangen  
 Placenta and Ovum Forceps  
 Pinzas para aborto y placenta  
 Pinze per placenta e per ovaie

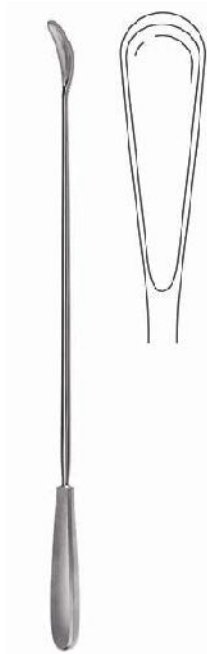

**WALLICH**  
 42,0 cm, 16 $\frac{1}{2}$ "  
 GO-1300-42



**MARTIN**  
 34,0 cm, 13 $\frac{3}{8}$ "  
 GO-1600-34



**BIERER**  
 33,0 cm, 13"  
 GO-1236-01



**BIERER**  
 33,0 cm, 13"  
 GO-1236-02



**BIERER**  
 33,0 cm, 13"  
 GO-1237-01



**BIERER**  
 33,0 cm, 13"  
 GO-1237-02



**Vorbereitung, Dermatologie**  
**Preparation, Dermatology**  
**Preparación, Dermatología**  
**Preparazione, Dermatalogia**



Hautstanzen, Nagel Instrumente  
 Dermal Punches, Nail Instruments  
 Trépanos cutáneos, Instrumentos para uñas  
 Trapani dermatici, Strumenti per unghie



Lupusküretten  
 Lupus curettes  
 Curetas para lupus  
 Raschiatoio per lupus



**PIFFARD**  
 14,0 cm, 5<sup>3</sup>/<sub>4</sub>"



**KEYES**  
 12,0 cm, 4<sup>3</sup>/<sub>4</sub>"

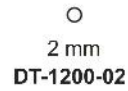

**KEYES**  
 12,0 cm, 4<sup>3</sup>/<sub>4</sub>"  
 DT-1210-00



**NAGELBOHRER**  
 DT-1400-00  
 komplett, complete,  
 completo, completo

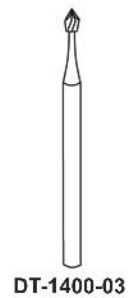
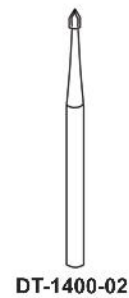
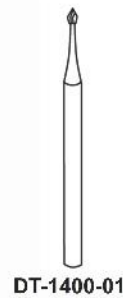

**Komedonenquetscher**  
**Comedo Extractors**  
**Saca-comedones**  
**Tiracomedoni**



**UNNA**  
14,0 cm, 5<sup>3</sup>/<sub>4</sub>"  
DT-000-14



**UNNA**  
14,0 cm, 5<sup>3</sup>/<sub>4</sub>"  
DT-1002-14



**SAALFELD**  
10,0 cm, 4"  
DT-1010-10



**SAALFELD**  
14,0 cm, 5<sup>3</sup>/<sub>4</sub>"  
DT-1012-14



**SCHAMBERG**  
10,0 cm, 4"  
DT-1020-10



**WALTON**  
14,0 cm, 5<sup>3</sup>/<sub>4</sub>"  
DT-1030-14



**FOX**  
14,0 cm, 5<sup>3</sup>/<sub>4</sub>"



Lupusküretten  
Lupus curettes  
Curetas para lupus  
Raschiatoio per lupus

Nagel Instrumente  
Nail Instruments  
Instrumentos para uñas  
Strumenti per unghie



059-1420-01

**FINGERRINGSÄGE**

17,0 cm, 6<sup>3</sup>/<sub>4</sub>"  
DT-1420-17



059-1430-01

**WALTON**

16,0 cm, 6<sup>1</sup>/<sub>4</sub>"  
DT-1430-16



**RADOLF**

13,5 cm, 5<sup>3</sup>/<sub>8</sub>"  
DT-1500-13



**NAGELZANGE**

13,5 cm, 5<sup>3</sup>/<sub>8</sub>"  
DT-1510-13



**NAGELZANGE**

13,0 cm, 5"  
DT-1600-13



**NAGELZANGE**

14,0 cm, 5<sup>1</sup>/<sub>2</sub>"  
DT-1610-13

DT-1610-































DT-1610-



**Knochenchirurgie**  
**Bone Surgery**  
**Cirurgía ósea**  
**Chirurgia ossea**



Scharfe Löffel  
Bone Curettes  
Cucharillas cortantes  
Curetta per ossa

		
	Fig. 0000 BC-1469-04	Fig. 0000 BC-1472-04
		
	Fig. 000 BC-1469-03	Fig. 000 BC-1472-03
		
	Fig. 00 BC-1469-02	Fig. 00 BC-1472-02
		
Fig. 000 BC-1467-03	Fig. 0 BC-1469-01	Fig. 0 BC-1472-01
		
Fig. 00 BC-1467-02	Fig. 1 BC-1469-11	Fig. 1 BC-1472-11
		
Fig. 0 BC-1467-01	Fig. 2 BC-1469-12	Fig. 2 BC-1472-12
		
Fig. 1 BC-1467-11	Fig. 3 BC-1469-13	Fig. 3 BC-1472-13
		
Fig. 2 BC-1467-12	Fig. 4 BC-1469-14	Fig. 4 BC-1472-14
		
Fig. 3 BC-1467-13	Fig. 5 BC-1469-15	Fig. 5 BC-1472-15
		
Fig. 4 BC-1467-14	Fig. 6 BC-1469-16	Fig. 6 BC-1472-16
		
<b>SCHEDÉ</b> 17,0 cm, 6 <sup>3</sup> / <sub>4</sub> "	<b>VOLKMANN</b> 17,0 cm, 6 <sup>3</sup> / <sub>4</sub> "	<b>BRUNS</b> 17,0 cm, 6 <sup>3</sup> / <sub>4</sub> "

Scharfe Löffel  
Bone Curettes  
Cucharillas cortantes  
Curetta per ossa

○  
Fig. 00000  
**BC-1448-04**

○  
Fig. 0000  
**BC-1448-03**

○  
Fig. 000  
**BC-1448-02**

○  
Fig. 00  
**BC-1448-01**

○  
Fig. 0  
**BC-1448-00**



**LEMPERT**  
21,5 cm, 8½"



**HALLE**  
21,0 cm, 8¼"

○  
Fig. 00  
**BC-1452-02**

○  
Fig. 0  
**BC-1452-01**

○  
Fig. 1  
**BC-1452-11**



○  
Fig. 00  
**BC-1487-02**

○  
Fig. 0  
**BC-1487-01**

○  
Fig. 1  
**BC-1487-11**

○  
Fig. 2  
**BC-1487-12**

**DAUBENSPECK**  
20,0 cm, 8"



Scharfe Löffel  
Bone Curettes  
Cucharillas cortantes  
Curetta per ossa



**WILLIGER**  
17,0 cm, 6<sup>3</sup>/<sub>4</sub>"

Fig. 1  
**BC-1430-11**

Fig. 2  
**BC-1430-12**



**WILLIGER**  
14,0 cm, 5<sup>1</sup>/<sub>2</sub>"

Fig. 0  
**BC-1406-00**

Fig. 1  
**BC-1406-01**

Fig. 2  
**BC-1406-02**



**MARTINI**  
14,0 cm, 5<sup>1</sup>/<sub>2</sub>"  
**BC-1408-00**

Fig. 00/0  
**BC-1408-00**  
14,0 cm, 5<sup>1</sup>/<sub>2</sub>"

Fig. 0/1  
**BC-1408-01**  
14,0 cm, 5<sup>1</sup>/<sub>2</sub>"

Fig. 1/2  
**BC-1408-12**  
14,0 cm, 5<sup>1</sup>/<sub>2</sub>"



**VOLKMANN**

**BC-1414-13**  
13,0 cm, 5"

**BC-1414-14**  
14,0 cm, 5<sup>1</sup>/<sub>2</sub>"

**BC-1414-17**  
17,0 cm, 6<sup>3</sup>/<sub>4</sub>"



**JANZEN**  
15,0 cm, 6"  
**BC-1411-15**



**JANZEN**  
16,0 cm, 6<sup>1</sup>/<sub>4</sub>"  
**BC-1410-16**

Dissektoren, Elevatorien  
Dissectors, Elecators  
Disecadores, Elevadores  
Dissettori, Elevatori

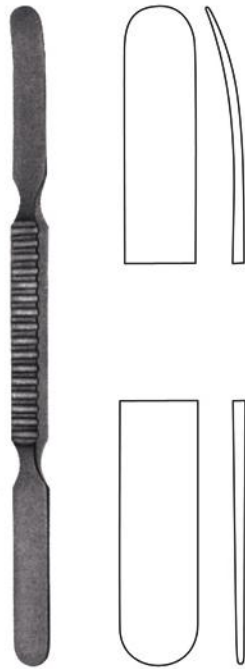

**WATSON-CHEYNE**  
17,5 cm, 6<sup>5</sup>/<sub>8</sub>"  
BC-1501-17



**MC DONALD**  
19,0 cm, 7<sup>1</sup>/<sub>2</sub>"  
BC-1440-19



**WILLIGER**  
17,0 cm, 6<sup>3</sup>/<sub>4</sub>"  
BC-1512-17



**WILLIGER**  
16,0 cm, 6<sup>1</sup>/<sub>4</sub>"  
BC-1512-16



**LANGENBECK**  
20,0 cm, 8"  
BC-1520-08



**LANGENBECK**  
20,0 cm, 8"  
BC-1520-10

Raspatorien  
Raspatories  
Periostótomos  
Periostotomi



1

**ADSON**

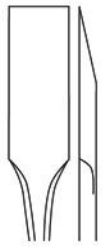

8 mm  
**063-1465-01**



7 mm  
**BC-1465-02**



7 mm  
**BC-1465-03**



7 mm  
**BC-1465-04**



5 mm

1

**BC-1476-15**



**LAMBOTTE**  
21,0 cm, 8 1/4"



10 mm  
**BC-1477-10**



15 mm  
**BC-1477-15**

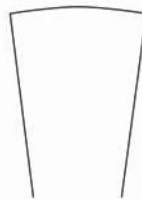

20 mm  
**BC-1477-20**

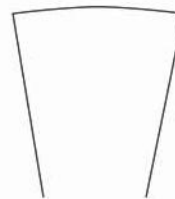

25 mm  
**BC-1477-25**

12,5 mm



**FARABEUF**  
15,0 cm, 6"  
**BC-1478-15**

Raspatorien  
Raspatories  
Periostótomos  
Periostotomi

12,5 mm

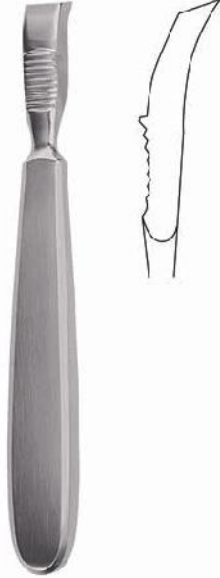

**FARABEUF**  
15,0 cm, 6"  
063-1479-15

16,0 mm



**LANGENBECK**  
19,0 cm, 7 1/2"  
BC-1472-19

15,0 mm



**SEDILLOT**  
21,0 cm, 8 1/4"  
BC-1488-21

4 mm **BC-1480-04**  
6 mm **BC-1480-06**  
8 mm **BC-1480-08**



**WILLIGER**  
16,0 cm, 6 1/4"



für Kinder  
for children  
para niños  
per bambini

**DOYEN**  
17,0 cm, 6 3/4"  
063-1485-17



für Kinder  
for children  
para niños  
per bambini

**DOYEN**  
17,0 cm, 6 3/4"  
BC-1487-17



für Erwachsene  
for adults  
para adultos  
per adulti

**DOYEN**  
17,0 cm, 6 3/4"  
BC-1481-17



für Erwachsene  
for adults  
para adultos  
per adulti

**DOYEN**  
17,0 cm, 6 3/4"  
BC-1485-17

Flachmeißel, Hohlmeißel, Osteotome  
 Chisels, Gouges, Osteotomes  
 Cinceles, Gubias, Osteótomos  
 Scalpelli, Sgorbie, Osteotomi



8,0 mm	<b>BC-1300-08</b>
10,0 mm	<b>BC-1300-10</b>
12,0 mm	<b>BC-1300-12</b>
14,0 mm	<b>BC-1300-14</b>
16,0 mm	<b>BC-1300-16</b>

13,5 cm, 5<sup>3</sup>/<sub>8</sub>"



8,0 mm	<b>BC-1301-08</b>
10,0 mm	<b>BC-1301-10</b>
12,0 mm	<b>BC-1301-12</b>
14,0 mm	<b>BC-1301-14</b>
16,0 mm	<b>BC-1301-16</b>

13,5 cm, 5<sup>3</sup>/<sub>8</sub>"



8,0 mm	<b>BC-1302-08</b>
10,0 mm	<b>BC-1302-10</b>
12,0 mm	<b>BC-1302-12</b>
14,0 mm	<b>BC-1302-14</b>
16,0 mm	<b>BC-1302-16</b>

13,5 cm, 5<sup>3</sup>/<sub>8</sub>"



3,0 mm	<b>BC-1334-03</b>
4,0 mm	<b>BC-1334-04</b>
5,0 mm	<b>BC-1334-05</b>
6,0 mm	<b>BC-1334-06</b>

**PARTSCH**  
 13,5 cm, 5<sup>3</sup>/<sub>8</sub>"



3,0 mm	<b>BC-1336-03</b>
4,0 mm	<b>BC-1336-04</b>
5,0 mm	<b>BC-1336-05</b>
6,0 mm	<b>BC-1336-06</b>

**PARTSCH**  
 13,5 cm, 5<sup>3</sup>/<sub>8</sub>"



10,0 mm	<b>BC-1361-10</b>
15,0 mm	<b>BC-1361-15</b>
20,0 mm	<b>BC-1361-20</b>
25,0 mm	<b>BC-1361-25</b>

**STILLE**  
 20,0 cm, 8"

Flachmeißel, Hohlmeißel, Osteotome  
 Chisels, Gouges, Osteotomes  
 Cinceles, Gubias, Osteótomos  
 Scalpelli, Sgorbie, Osteotomi



10,0 mm	BC-1360-10
15,0 mm	BC-1360-15
20,0 mm	BC-1360-20
25,0 mm	BC-1360-25

**STILLE**  
20,0 cm, 8"



10,0 mm	BC-1362-10
15,0 mm	BC-1362-15
20,0 mm	BC-1362-20
25,0 mm	BC-1362-25

**STILLE**  
20,0 cm, 8"



4,0 mm	BC-1318-04
6,0 mm	BC-1318-06
8,0 mm	BC-1318-08
10,0 mm	BC-1318-10
12,0 mm	BC-1318-12
14,0 mm	BC-1318-14

**ALEXANDER**  
18,0 cm, 7"



4,0 mm	BC-1319-04
6,0 mm	BC-1319-06
8,0 mm	BC-1319-08
10,0 mm	BC-1319-10
12,0 mm	BC-1319-12
14,0 mm	BC-1319-14

**ALEXANDER**  
18,0 cm, 7"



6,0 mm	BC-1350-06
9,0 mm	BC-1350-09
13,0 mm	BC-1350-13
16,0 mm	BC-1350-16
19,0 mm	BC-1350-19
25,0 mm	BC-1350-25
32,0 mm	BC-1350-32

**SMITH-PETERSEN**  
20,0 cm, 8"



6,0 mm	BC-1351-06
9,0 mm	BC-1351-09
13,0 mm	BC-1351-13
16,0 mm	BC-1351-16
19,0 mm	BC-1351-19
25,0 mm	BC-1351-25
32,0 mm	BC-1351-32

**SMITH-PETERSEN**  
20,0 cm, 8"

Flachmeißel, Hohlmeißel, Osteotome, Hämmer  
 Chisels, Gouges, Osteotomes, Mallets  
 Cinceles, Gubias, Osteótomos, Martillos  
 Scalpelli, Sgorbie, Osteotomi, Martelli



9,0 mm	BC-1352-09
14,0 mm	BC-1352-14
16,0 mm	BC-1352-16
19,0 mm	BC-1352-19
25,0 mm	BC-1352-25

**SMITH-PETERSEN**  
20,0 cm, 8"



9,0 mm	BC-1353-09
14,0 mm	BC-1353-14
16,0 mm	BC-1353-16
19,0 mm	BC-1353-19
25,0 mm	BC-1353-25

**SMITH-PETERSEN**  
20,0 cm, 8"



6,0 mm	BC-1450-06
15,0 mm	BC-1450-15
20,0 mm	BC-1450-20
25,0 mm	BC-1450-25
30,0 mm	BC-1450-30
38,0 mm	BC-1450-38
44,0 mm	BC-1450-44
50,0 mm	BC-1450-50

**LAMBOTTE**  
24,0 cm, 9 1/2"



6,0 mm	BC-1451-06
15,0 mm	BC-1451-15
20,0 mm	BC-1451-20
25,0 mm	BC-1451-25
30,0 mm	BC-1451-30
38,0 mm	BC-1451-38
44,0 mm	BC-1451-44
50,0 mm	BC-1451-50

**LAMBOTTE**  
24,0 cm, 9 1/2"



Ø 30 mm  
220 g

**COLLIN**  
20,0 cm, 8"  
BC-1132-20



Ø 22 mm  
200 g

**PARTSCH**  
18,0 cm, 7"  
BC-1145-18

mit Bleifüllung  
lead filled head  
cabezal relleno de plomo  
testa di piombo



Ø 45 mm  
300 g

**BERGMANN**  
24,0 cm, 9 1/2"  
BC-1201-24



**Sterilisation**  
**Sterilization**  
**Esterilización**  
**Sterilizzazione**





Sterilisierzangen  
Sterilizing Forceps  
Pinzas para esterilización  
Pinze per sterilizzazione



20,0 cm, 8"  
ST-1160-20



**CHEATTLE**  
27,0 cm, 10<sup>5</sup>/<sub>8</sub>"  
ST-1163-27



**ROGGE**  
23,0 cm, 9"  
ST-1164-23



**PYE-SMITH (HARRISON)**  
30,0 cm, 12"  
ST-1166-30



**MAYO**  
14,0 cm, 5<sup>1</sup>/<sub>2</sub>"  
ST-1151-14



**BUNT**  
12,0 cm, 4<sup>3</sup>/<sub>4</sub>"  
ST-1154-12



#### STANDZYLINDER

Ø 75 x 130 mm	HW-1142-06
Ø 75 x 175 mm	HW-1142-07
Ø 100 x 175 mm	HW-1142-08
Ø 100 x 200 mm	HW-1142-09



#### RUNDE SCHALE

Ø 40,0 mm	HW-1130-04
Ø 60,0 mm	HW-1130-06
Ø 80,0 mm	HW-1130-08
Ø 100,0 mm	HW-1130-10
Ø 120,0 mm	HW-1130-12
Ø 150,0 mm	HW-1130-15



#### NIERENSCHALE

170 mm	HW-1140-17
250 mm	HW-1140-25
275 mm	HW-1140-27



#### SPÜLSCHALE

165 x 55 mm	0,75 l	HWI-1133-00
175 x 70 mm	1,00 l	HWI-1133-10
225 x 100 mm	2,00 l	HWI-1133-20
240 x 95 mm	2,75 l	HWI-1133-30
260 x 120 mm	4,00 l	HWI-1133-40
290 x 100 mm	5,00 l	HWI-1133-50
315 x 150 mm	5,50 l	HWI-1133-60
325 x 135 mm	8,00 l	HWI-1133-70
360 x 165 mm	12,00 l	HWI-1133-80
415 x 150 mm	14,00 l	HWI-1133-90

Schalen  
Trays  
Bandejas  
Bacinelle



#### INSTRUMENTENKÄSTCHEN

200 x 150 x 25 mm	HW-1200-01
260 x 180 x 30 mm	HW-1200-02
300 x 220 x 30 mm	HW-1200-03
350 x 220 x 40 mm	HW-1200-04
220 x 170 x 50 mm	HW-1200-05
280 x 200 x 50 mm	HW-1200-06
320 x 240 x 50 mm	HW-1200-07
370 x 270 x 50 mm	HW-1200-08
420 x 320 x 50 mm	HW-1200-09



#### NAEDELDOSE

**HW-1300-00**  
Ø 65 x 17 mm  
Außen- und Innendose  
Exterior and interior box  
Caja exterior e interior  
Scatola esterna es interiore

**HW-1300-01**  
Ø 62 x 13 mm  
Innendose allein  
Interior box only  
Caja interior, suelta  
Scatola interiore sola



**SPÜLSCHALE  
MIT SKALIERUNG**  
25 ccm  
HW-310-25



**SPÜLBECHER  
MIT SKALIERUNG**  
50 ccm  
HW-310-50

# SURGICAL INSTRUMENTS CATALOGUE



+92 (318) 763 6989  
www.andimaxsurgical.com  
info@andimaxsurgical.com  
P.O. Gohad Pur Bonkan, Sialkot - 51310 Pakistan.

